



# User Guide

Receiver

# R-N800A

musicCast **EN**

# TABLE OF CONTENTS

## **BEFORE USE 7**

---

<b>Please read first .....</b>	<b>7</b>
About this product and manual .....	7
Terminology and technical explanations .....	8
<b>Input sources playable with this product .....</b>	<b>9</b>
Compatible input sources .....	9
Compatibility with MusicCast .....	10
<b>Accessories .....</b>	<b>11</b>
Checking the accessories .....	11

## **NAMES OF PARTS AND THEIR FUNCTIONS 13**

---

<b>Unit .....</b>	<b>13</b>
Front panel .....	13
Front display .....	16
Rear panel .....	19
<b>Remote control .....</b>	<b>21</b>
Remote control .....	21

## **PREPARATION 24**

---

<b>Preparing the remote control .....</b>	<b>24</b>
How to insert batteries, and its operating range .....	24
<b>Connecting external devices .....</b>	<b>25</b>
Connecting audio devices .....	25
Connecting to your computer (USB DAC function) .....	26
<b>Connecting speakers .....</b>	<b>28</b>
Connecting speakers .....	28
Making bi-wiring connections .....	31
Connecting a subwoofer .....	32
Trigger connection .....	33
<b>Connecting radio antennas .....</b>	<b>34</b>
Connecting an FM antenna .....	34
Connecting an AM antenna .....	35
Connecting a DAB/FM antenna .....	36

<b>Preparing a network connection</b>	<b>37</b>
To make a network connection	37
Connecting a network cable (wired connection)	38
Preparing the wireless antenna (wireless connection)	39
<b>Turning the product ON</b>	<b>40</b>
Connecting the power cord	40
Turning the power ON	41
<b>Configuring MusicCast settings (connecting to a network)</b>	<b>43</b>
Registering with the MusicCast network	43
<b>Automatic adjustment of speaker settings (YPAO)</b>	<b>44</b>
Running YPAO	44
Error and warning messages	48
Using the app to check YPAO measurements and change settings	50
<b>PLAYBACK</b>	<b>52</b>
<hr/>	
<b>Basic operations</b>	<b>52</b>
Selecting the output speakers	52
Selecting an input source	53
Adjusting the volume	54
Switching the front display	55
<b>Adjusting the sound to your preference</b>	<b>56</b>
Enjoying Pure Direct playback (PURE DIRECT)	56
Adjusting bass and treble (BASS/TREBLE)	57
Adjusting left/right volume balance (BALANCE)	58
Making it easier to hear bass and treble at low volumes (LOUDNESS)	59
<b>Listening to the radio</b>	<b>60</b>
Preparing to listen to the radio	60
Selecting a radio station	63
Displaying the Radio Data System information	64
Displaying the DAB information	65
Auto-registering FM radio stations (auto preset)	66
Registering radio stations manually	67
Removing the registration of a radio station	68
<b>Playing via a Bluetooth® connection</b>	<b>69</b>
Playing the audio of a Bluetooth device on this product (audio reception)	69
Playing this product's audio through Bluetooth speakers/headphones (audio transmission)	70
<b>Listening to music via AirPlay</b>	<b>72</b>
Playing music via AirPlay	72

<b>Listening to internet radio</b> .....	<b>73</b>
Selecting an internet radio station .....	73
<b>Listening to streaming services</b> .....	<b>74</b>
Listening to streaming services .....	74
<b>Playing songs on media servers (PC/NAS)</b> .....	<b>75</b>
Playing songs on media servers (PC/NAS) .....	75
<b>Playing audio from your computer (USB DAC)</b> .....	<b>77</b>
Playing music that is on your computer .....	77
<b>Option menu (settings for each input source)</b> .....	<b>78</b>
Basic operation of the Option menu .....	78
List of Option menu .....	79
Correcting volume difference between input sources .....	80
Displaying audio signal information .....	81
Setting the reception mode (stereo/mono) for FM radio .....	82
Performing an initial scan for DAB radio reception .....	83
Checking reception strength of each DAB channel label .....	84
Setting volume interlock with this product when playing an AirPlay/Bluetooth device .....	85
Setting auto playback .....	86
Improving intermittently disrupted sound from digital audio inputs .....	87

---

## **USEFUL FUNCTIONS** **88**

<b>Preset functions</b> .....	<b>88</b>
Registering your favorite content to presets .....	88
Recalling content registered to a preset .....	90
<b>Sleep timer function</b> .....	<b>92</b>
Configuring the time for the sleep timer .....	92

---

## **SETTINGS** **93**

<b>Menus</b> .....	<b>93</b>
Menu structure .....	93

<b>Setup menu (changing function settings)</b> .....	<b>94</b>
Basic operation of the Setup menu .....	94
List of Setup menu items .....	95
Configuring a network .....	96
Configuring Bluetooth .....	101
Configuring YPAO .....	102
Configuring the volume .....	103
Configuring auto power standby .....	104
Setting the product to ECO mode .....	105
Configuring the front display .....	106
<b>Advanced Setup menu (changing system settings)</b> .....	<b>107</b>
Basic operation of the Advanced Setup menu .....	107
List of Advanced Setup menu items .....	108
Configuring the menu language .....	109
Configuring the Remote ID .....	110
Changing the FM/AM tuning frequency setting .....	111
Initializing settings .....	112
Switching speaker impedance .....	113
Correcting the knobs .....	114
<b>UPDATING</b> .....	<b>115</b>
<hr/>	
<b>Checking the version of firmware</b> .....	<b>115</b>
Checking the version of firmware .....	115
<b>Updating the firmware</b> .....	<b>116</b>
Updating the firmware .....	116
Updating the firmware via your network .....	117
<b>TROUBLESHOOTING</b> .....	<b>118</b>
<hr/>	
<b>If you think there is a problem</b> .....	<b>118</b>
If you think there is a problem, the 1st step is checking the following .....	118
Problems with power, system, and/or remote control .....	119
Problems with the audio .....	121
Problems with FM radio .....	123
Problems with AM radio .....	124
Problems with DAB radio .....	125
Problems with USB DAC .....	126
Problems with network .....	128
Problems with Bluetooth .....	131
Errors shown on the front display .....	132

# APPENDIX

**133**

---

<b>Product care</b> .....	<b>133</b>
Taking care of this product .....	133
<b>Making wireless network connections</b> .....	<b>134</b>
Selecting the wireless method of connecting to the network .....	134
Using the WPS button to make a wireless connection .....	135
Making a wireless connection with your iPhone (WAC) .....	136
Making a wireless connection manually .....	137
<b>Supported devices and formats</b> .....	<b>138</b>
Supported Bluetooth devices .....	138
Supported file formats on this product (network) .....	139
Playable formats using USB DAC .....	140
<b>Trademarks</b> .....	<b>141</b>
Trademarks .....	141
<b>Specifications</b> .....	<b>142</b>
Specifications .....	142
<b>Default values</b> .....	<b>148</b>
List of default values of the Option menu .....	148
List of default values of the Setup menu .....	149
List of default values of the Advanced Setup menu .....	150

# BEFORE USE

## Please read first

### About this product and manual

---

Thank you very much for purchasing this Yamaha product. This product is a network-compatible Receiver (2-channel stereo amplifier) which lets you play music content from the radio or a network in your home as well as analog and digital audio inputs. With the YPAO function which optimizes the sound field automatically, you can enjoy the sound that best matches your room.

This manual (guide) is organized as follows. Please be sure to read each of the guides that came with the product and keep them handy for easy reference.

#### **Safety Guide (Included with the Product)**

Lists important safety precautions that should be read prior to use.

#### **Quick Guide (Included with the Product)**

This guide explains things from basic connections up through playing Internet radio.

#### **User Guide (This Guide)**

This provides explanations of all functions, such as information that is not addressed in the Quick Guide.

- In the User Guide, iPhone and iPad are referred to collectively as “iPhone”. Unless indicated within an explanation, references to “iPhone” mean iPhone and iPad.
- Symbols used in the User Guide



• **CAUTION** is used with information about potential injuries.

- **NOTICE** is used with information for preventing product failure, damage or malfunction, and/or loss of data.
- **NOTE** is used with supplementary information that is helpful to know.
- [Search tag] are keywords for searching.

You can download the latest manuals from the following website.

<https://download.yamaha.com/>

## Terminology and technical explanations

---

Following are explanations of terminology used in this guide.

### **USB DAC**

The USB DAC converts digital audio signals, sent via a USB cable connected to a computer, into an analog audio signal, which allows it to be played. This makes it possible for computer applications to play high-quality audio.

### **YPAO (Yamaha Parametric room Acoustic Optimizer)**

This is a proprietary Yamaha technology that automatically optimizes for room acoustics. A special YPAO microphone is used to detect speaker connections and measure the distance from them to the listening position. It measures the acoustic characteristics of the space and automatically adjusts parameters such as volume balance and frequency characteristics.

### **Bi-wiring Connections**

When connecting an amplifier to speakers, this connection method uses separate wires for the low-frequency speaker unit (woofer) and the mid-high frequency speaker unit (tweeter). This method of connection is possible if the speakers are bi-wiring compatible (if they have terminals for both low-frequencies and mid/high frequencies).

### **Loudness**

This function makes it easier to hear bass and treble even at low volumes. It allows the listener to enjoy natural sound even at low volumes by compensating for the human auditory characteristic that makes it difficult to hear bass and treble at low volumes.

Please refer to the following website for other terms and technical explanations. It explains terms and technologies related to Yamaha AV products in general, not just for this product.

<https://manual.yamaha.com/av/cm/glossary/>



## Input sources playable with this product

### Compatible input sources

As illustrated below, this product supports playing a variety of input sources.

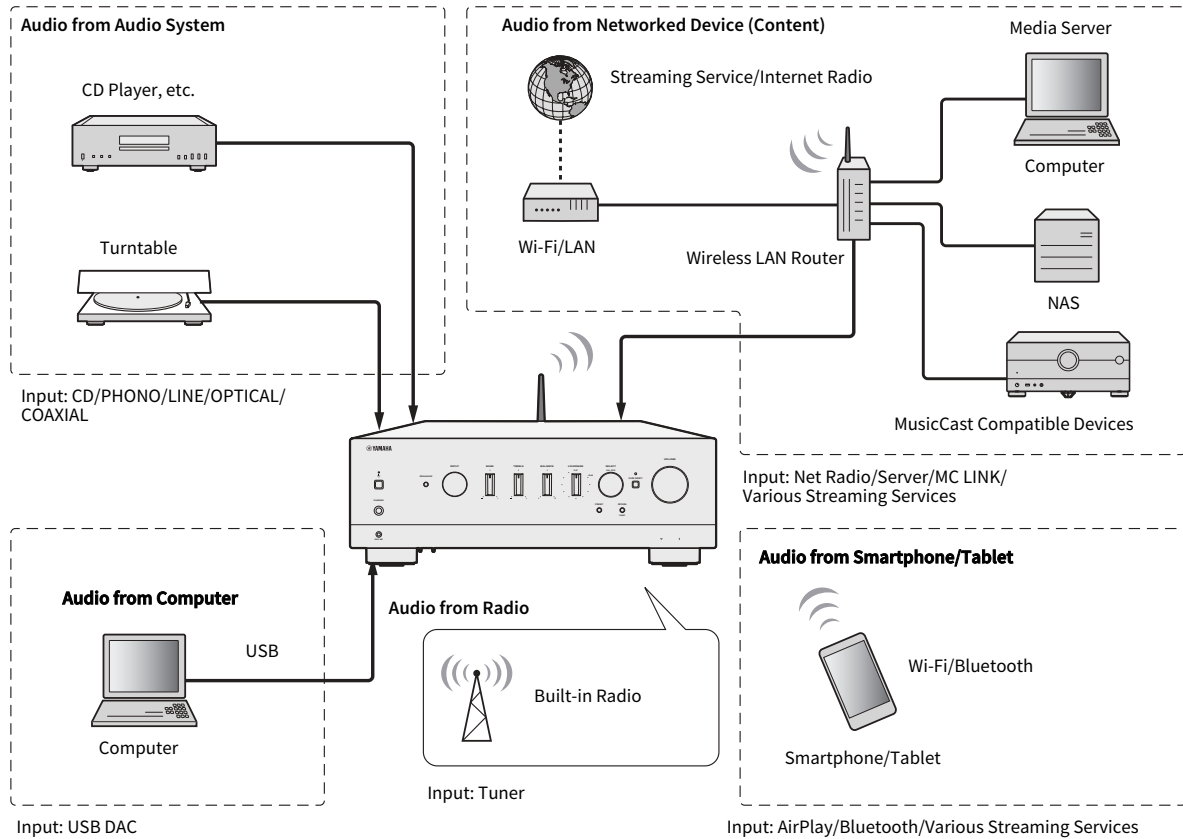

#### Related links (for connection)

- “Connecting external devices” (p.25)
- “Connecting radio antennas” (p.34)
- “To make a network connection” (p.37)

#### Related links (for playback)

- “Selecting an input source” (p.53)
- “Listening to the radio” (p.60)
- “Playing via a Bluetooth® connection” (p.69)
- “Listening to music via AirPlay” (p.72)
- “Listening to internet radio” (p.73)
- “Listening to streaming services” (p.74)
- “Playing songs on media servers (PC/NAS)” (p.75)
- “Playing audio from your computer (USB DAC)” (p.77)

## Compatibility with MusicCast

---



This product is compatible with MusicCast. This makes it possible to share music with MusicCast-compatible devices located in multiple rooms. Its dedicated app, “MusicCast Controller”, is easy to use and allows users to enjoy music from smartphones, media servers (PC/NAS), Internet radio and streaming services from anywhere in the home.

For details on MusicCast and compatible devices, please visit the Yamaha website. For more information about the app, search “MusicCast Controller” in the App Store or Google Play.

## Accessories

### Checking the accessories

This product comes with the following accessories. Check and make sure that you have all of the included accessories.

- Power cord

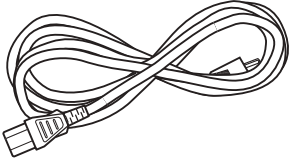

- YPAO microphone

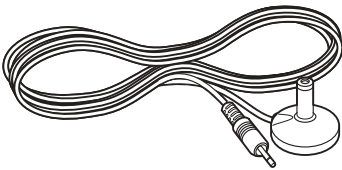

- DAB/FM antenna (Models for U.K., Europe, Russia and Australia)

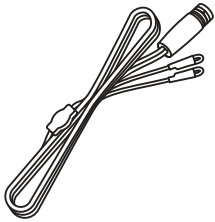

- AM antenna (Models for U.S.A., Canada, China, Korea, Asia, Taiwan and for Central and South America)

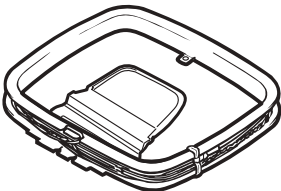

- FM antenna (Models for U.S.A., Canada, China, Korea, Asia, Taiwan and for Central and South America)

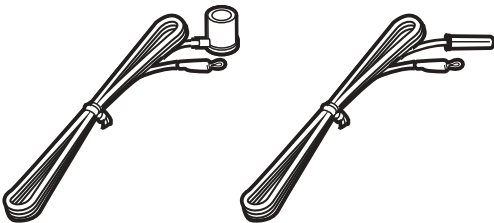

\* One of the above is supplied depending on the region of purchase.

BEFORE USE > Accessories

Remote control

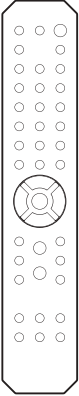

Batteries (AA, R6, UM-3) (x2)

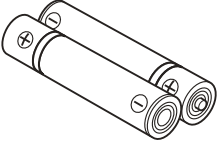

Safety Guide

Quick Guide

# NAMES OF PARTS AND THEIR FUNCTIONS

## Unit

### Front panel

The following are the names of parts on the front of the unit and an explanation of their functions.

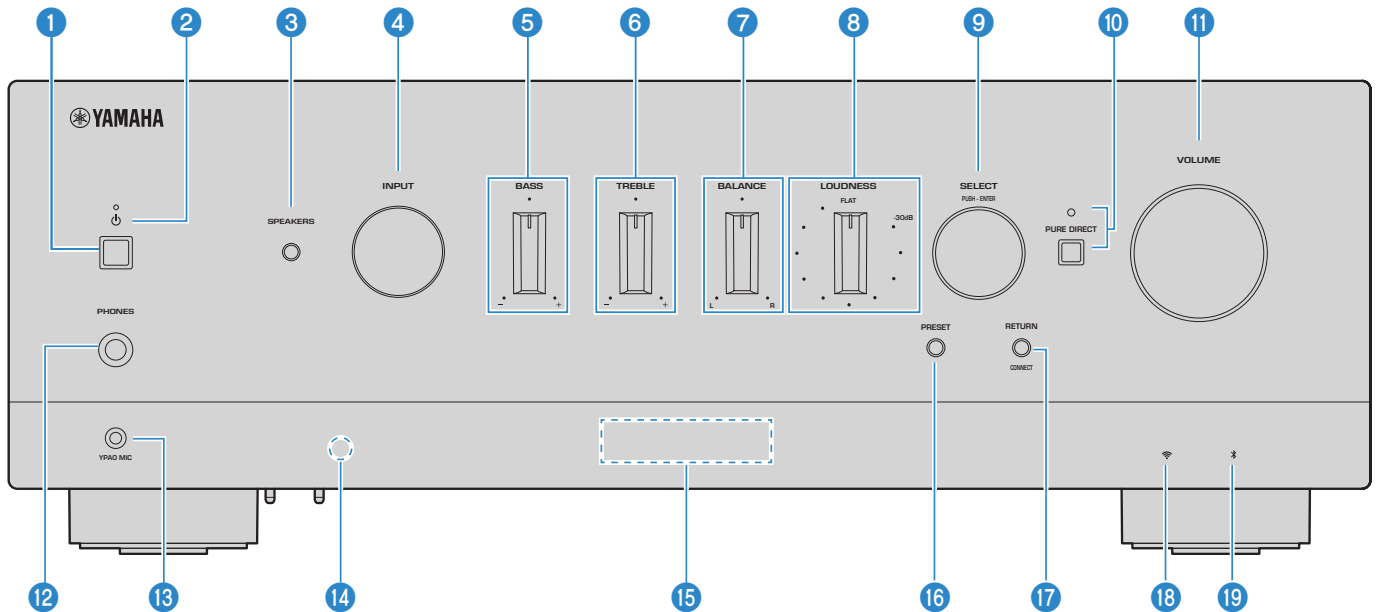

#### 1 (Power) Switch

Turns the power of the product ON (☰) / OFF (☷) (p.41).

With the power ON, press the (⏻) (Power) key on the remote control to switch the power between ON and Standby. This product also goes into Standby in the following situations.

- When the Auto Power Standby function is active (p.104)

#### NOTE

The remote control does not work if the power is OFF. This product cannot also be linked with a Bluetooth device, a network device, or MusicCast Controller App.

#### 2 Power Indicator

Lights up as follows to indicate the state of power.

Power ON: Indicator lights up.

Power in Standby: Indicator is faintly lit.

Power OFF: Indicator is off.

#### NOTE

When the indicator is flashing, it means the protective circuit has been activated and the power will not turn ON, in order to protect the product. Please contact an authorized Yamaha service center to have it repaired.

#### 3 SPEAKERS

Switches the speakers connected to the SPEAKERS L/R A and B jacks on the rear panel (p.52).

## NAMES OF PARTS AND THEIR FUNCTIONS > Unit

- 4 INPUT**  
Selects the input source (p.53).
- 5 BASS**  
Adjusts the volume of the low-frequency range (p.57).
- 6 TREBLE**  
Adjusts the volume of the high-frequency range (p.57).
- 7 BALANCE**  
Adjusts the left/right balance of the volume (p.58).
- 8 LOUDNESS**  
Adjusts to make it easier to hear bass and treble even at low volumes (p.59). If the YPAO Volume function (p.102) is enabled, LOUDNESS adjustment cannot be used.
- 9 SELECT (PUSH-ENTER)**  
Used for things like operating the menus on the front display. Turn this to select an item, and press it to confirm the selection.
- 10 PURE DIRECT/Indicator**  
Switches the Pure Direct function ON/OFF (p.56). When this is ON, the indicator lights up, and the front display turns off.
- 11 VOLUME**  
Adjusts the volume.
- 12 PHONES jack**  
For plugging in headphones (compatible with standard stereo phone plugs).  
**NOTE**  
Audio cannot be output to speakers connected to this product when headphones are plugged in. Also, output from the PRE OUT jack turns OFF.
- 13 YPAO MIC jack**  
For connecting the included YPAO microphone (p.44).
- 14 Remote control signal receiver**  
Receives the signal (infrared) from the remote control (p.24).
- 15 Front Display**  
Displays various information and menus (p.16).
- 16 PRESET**  
Used for recalling registered (preset) radio stations (p.63) and registered songs/Internet radio stations (p.90).
- 17 RETURN/CONNECT**  
Used for things like operating the menus on the front display.  
Also used when registering this product on the MusicCast Network (p.43).

## NAMES OF PARTS AND THEIR FUNCTIONS > Unit

### 18 **Wireless LAN indicator**

Lights up when this product is connected to a wireless network (p.134).

### 19 **Bluetooth indicator**

Lights up when a Bluetooth device is connected (p.69).

### **Related links**

“Taking care of this product” (p.133)

## Front display

---

The following is an explanation of what is shown on the front display.

### ■ Basic indication

This indication is shown during playback. What is shown differs depending on the current input source. The following is an example of the indication during playback of a media server.

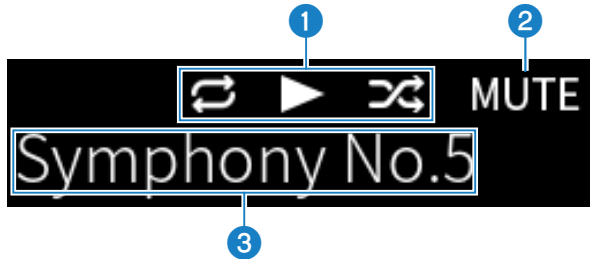

#### 1 Play status icon

Shown according to the playback status of the song/station (radio station).

##### Repeat All/1 Song (↺/↻)

Shown when the input is "Server" and Repeat play is set. Please note that it may not be shown when playing music on a smartphone or tablet, since it depends on the status of the device.

##### Play/Pause (▶/⏸)

Shown when the input is "Server" or "Bluetooth" and it is playing or paused.

Play icon is also shown when the input is "AirPlay" or "Net Radio" and it is playing.

##### Shuffle (🎲)

Shown when the input is "Server" and Shuffle play is set. Please note that it may not be shown when playing music on a smartphone or tablet, since it depends on the status of the device.

#### 2 -∞ (When at minimum volume) /MUTE

When the volume is at the minimum, "-∞" is shown flashing. When muted, "MUTE" is shown flashing.



### 3 Information area

The following information is shown depending on the selected input.

#### **When selecting CD, PHONO, LINE1, LINE2, OPTICAL1, OPTICAL2, COAXIAL1, COAXIAL2 or a music streaming service**

The input name is displayed.

#### **When selecting USB DAC**

The audio format and sampling frequency of the playback signal is displayed.

#### **When selecting Server or Net Radio**

The information of the current song or station is displayed. To switch the displayed item, press the DISPLAY key on the remote control.

#### **When selecting AirPlay or Bluetooth**

The information of the current song or the input name is displayed. To switch the displayed item, press the DISPLAY key on the remote control.

#### **When selecting TUNER**

The frequency is displayed. The information of Radio Data System (models for U.K., Europe and Russia) or DAB (models for U.K., Europe, Russia and Australia) is also displayed. To switch the displayed item, press the DISPLAY key on the remote control.

#### **NOTE**

Some text characters may not be available, and “\_” is displayed.

## ■ Browse indication

This indication is shown only when the input source is “Server” or “Net Radio” and you are selecting the desired song or station.

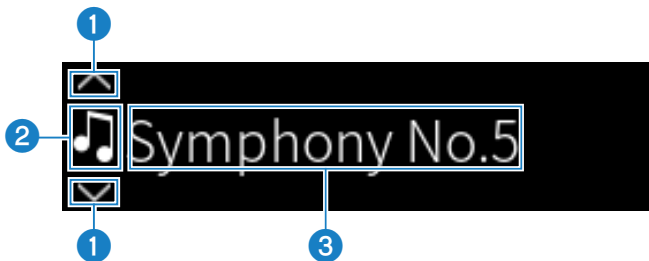

#### 1 Operation direction indicator

Available browse direction(s) are shown.

#### 2 File information icon

The type of content currently being shown is indicated by this icon.

#### **When Server is selected**

 Indicates a music file.

Music files in formats not supported by this product may also be shown (p.139).

 Indicates a folder.

 Indicates a file that cannot be played.

#### **When Net Radio is selected**

 Indicates a folder.

 Indicates a radio station that can be selected.

**3 Content information area**

Information such as file names and station names are shown.

**NOTE**

Some text characters may not be available, and “\_” is displayed.

**■ Warming up indication**

This indication is shown immediately after this product is turned ON. Icons are shown to indicate the temperature condition of the amp. Use this as an estimate of the time until the sound quality will stabilize.

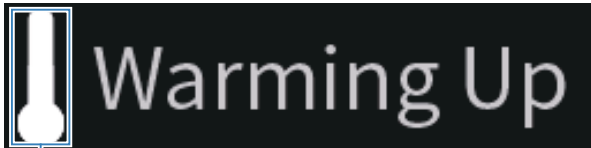

1

**1 Temperature condition icons**

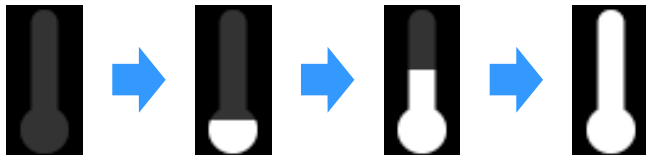

Currently warming up.

Warmed up.

**NOTE**

- The brightness of the display is dimmed to protect the display unit when the product is not operated for a certain amount of time. The display returns to its normal brightness when the remote control or front panel is operated.
- When PURE DIRECT is ON, the front display turns OFF. After turning OFF, the display comes back ON when the remote control or front panel is operated.
- The basic indication turns off if no operations are performed for a certain amount of time. The time until the display turns off can be changed on the Setup menu.
- The maximum number of text characters for displaying content information (names of stations/songs, etc.) on the basic indication or browse indication varies depending on the selected input and the type of characters.

**Related links**

“Configuring the front display” (p.106)

## Rear panel

The following are the names of parts on the rear of the unit and an explanation of their functions.

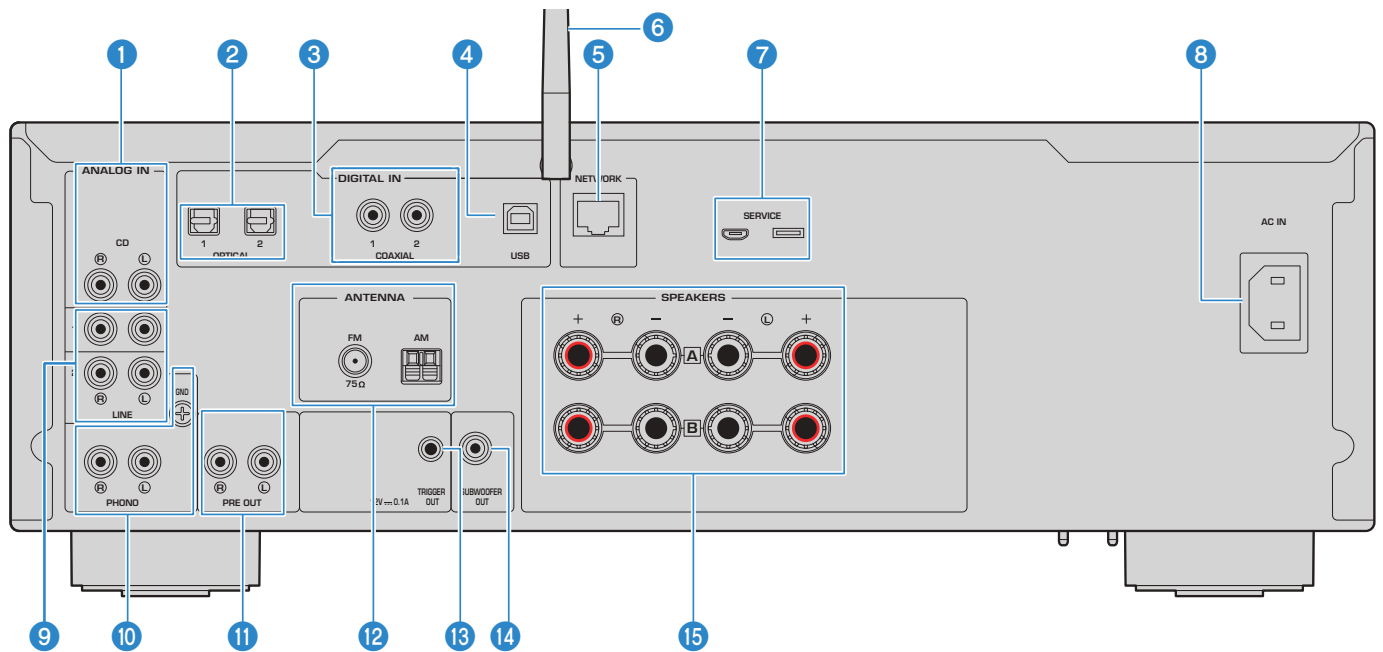

**1 CD IN jacks**

For connecting to the analog audio OUT of devices like CD players (p.25).

**2 OPTICAL 1-2 IN jacks**

For connecting to external devices with an optical digital output (p.25).

**3 COAXIAL 1-2 IN jacks**

For connecting to external devices with a coaxial digital output (p.25).

**4 USB port**

For connecting to computers (p.26). Compatible with USB type B connectors.

**5 NETWORK jack**

For connecting a network cable when connecting this product to a wired network (p.38).

**6 Wireless antenna**

For connecting this product to a wireless network (Wi-Fi) (p.39). It is also used for Bluetooth connections (p.69).

**7 SERVICE ports**

These are service ports that are used when performing repairs, etc. Do not plug anything into them.

**8 AC IN jack**

For connecting the included power cord (p.40).

**9 LINE 1-2 IN jacks**

For connecting to external devices with analog audio OUT (p.25).

## NAMES OF PARTS AND THEIR FUNCTIONS > Unit

### 10 **PHONO IN jacks**

#### **GND jack**

For connecting to a turntable (record player) (p.25).

### 11 **PRE OUT jacks**

Outputs the same audio signal that is output to the SPEAKERS L/R jacks (p.25).

### 12 **ANTENNA jack**

For connecting to a radio antenna (p.34).

### 13 **TRIGGER OUT jack**

For connecting to external devices that support the trigger function (p.33).

### 14 **SUBWOOFER OUT jack**

For connecting to a subwoofer with a built-in amplifier (p.32).

### 15 **SPEAKERS L/R jacks**

For connecting to speakers (p.28).

## Remote control

### Remote control

The following are the names of the parts of the remote control and explanations of their functions.

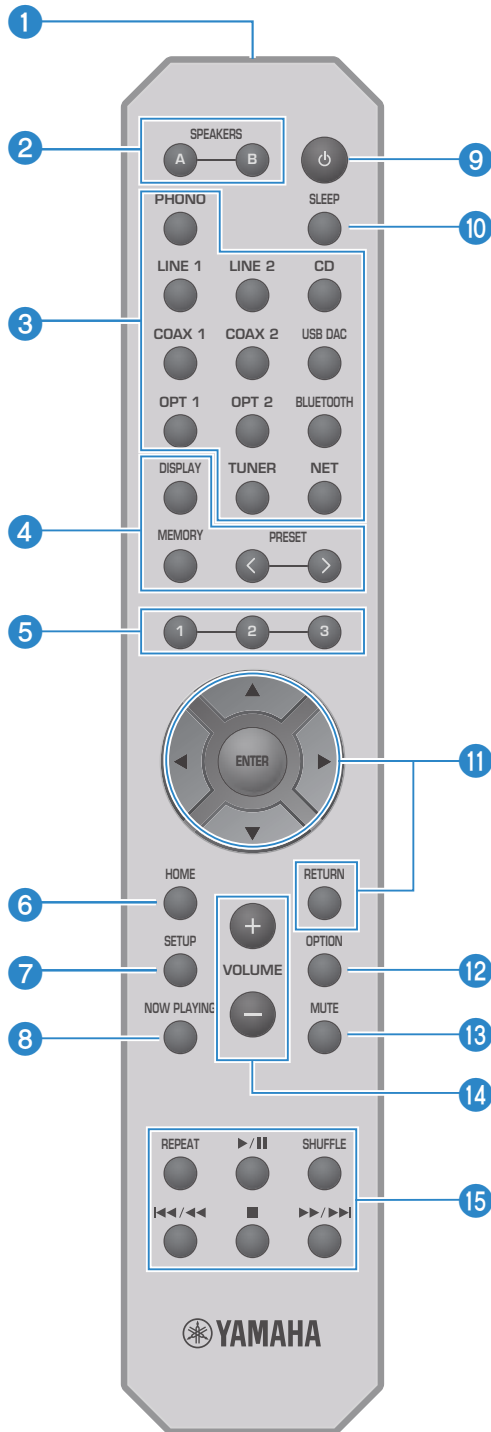

**1 Remote control signal transmitter**

Sends the remote control signal (infrared).

**2 SPEAKERS A and B keys**

For switching the output speakers. Toggles Speakers A or B ON/OFF each time it is pressed (p.52).

**3 Input source selection keys**

Selects the input source to play (p.53).

**NOTE**

Pressing the NET key repeatedly switches between the network sources.

**4 DISPLAY key**

Switches the display between different kinds of information (p.16).

**MEMORY key**

For registering radio stations (presets) (p.67). It can also be used for registering songs on media servers or Internet radio stations (p.88).

**PRESET keys**

Used for recalling registered (preset) radio stations (p.63) and registered songs/Internet radio stations (p.90).

**5 1/2/3 keys**

For registering and recalling your favorite radio stations or network content to separate presets (p.88).

**6 HOME key**

Goes to the very top level when selecting music files, folders, etc.

**7 SETUP key**

Opens the Setup menu (p.94).

**8 NOW PLAYING key**

Shows info about the currently playing network content.

**9  (Power) key**

Switches the power of this product between ON and Standby (p.41).

**10 SLEEP key**

Sets the sleep timer (p.92).

**11 Menu operation keys**

**▲ ▼ ◀ ▶ (cursor keys), ENTER, and RETURN**

For operating the menus.

**12 OPTION key**

Opens the Option menu (p.78).

**13 MUTE key**

Mutes the sound. Pressing it again returns the volume to its previous level.

**14 VOLUME +/- keys**

Adjusts the volume (p.54).

**15 Playback keys**

**REPEAT key, ▶/■ (Play/Pause) key, SHUFFLE key, ⏮/⏪ (Skip/Rewind) key, ■ (Stop) key, ⏭/⏩ (Fast-Forward/Skip) key**

For operating playback, such as a media server, Internet radio, or Bluetooth.

# PREPARATION

## Preparing the remote control

### How to insert batteries, and its operating range

Put the included batteries into the remote control facing the correct way (+/-).

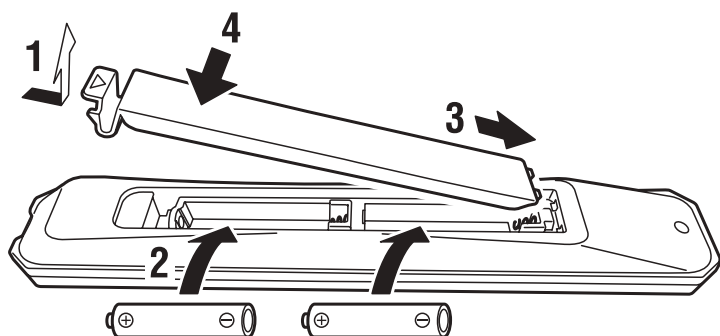

The operating range of the remote control is as illustrated.

Point the remote control at the remote control signal (infrared) receiver when operating it.

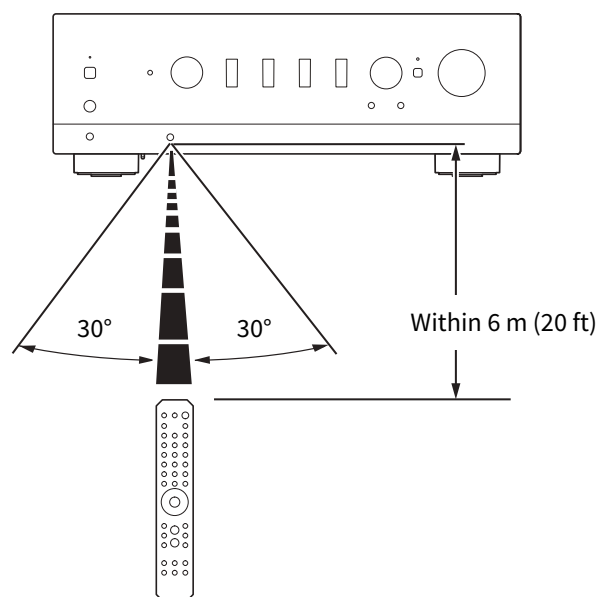



## Connecting external devices

### Connecting audio devices

This explains connecting audio devices, such as a CD player, to the product.

Use the type of cable appropriate for the jacks of the device to be connected, such as an RCA cable, optical fiber cable, or coaxial cable, which are commercially available.

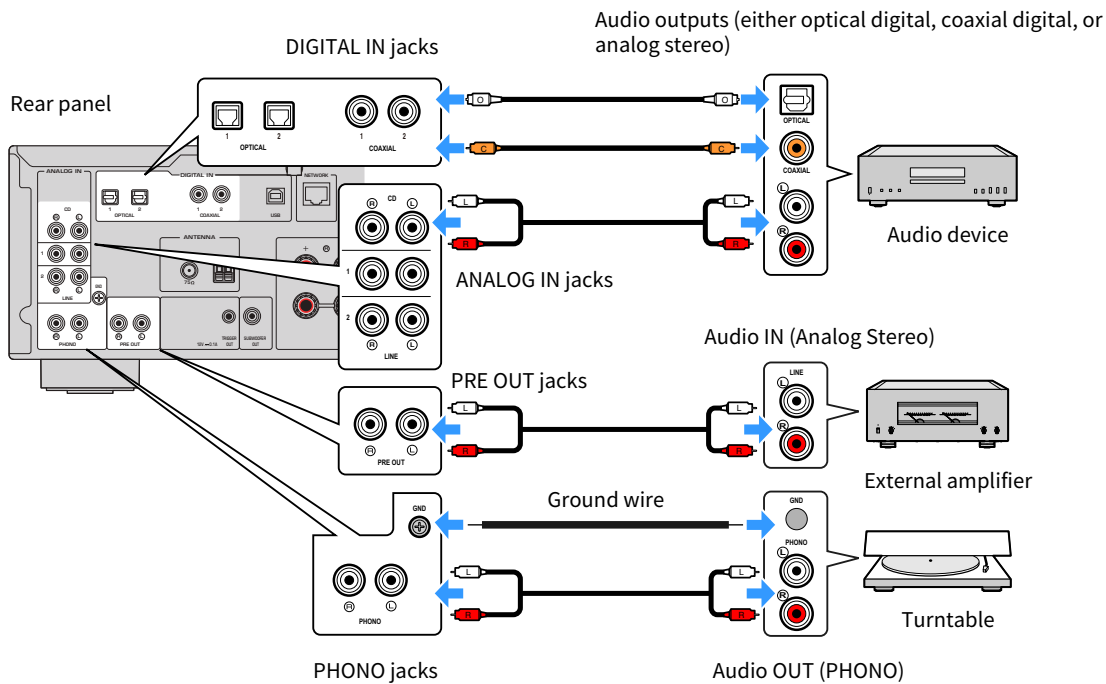

#### NOTE

- The DIGITAL IN jacks of this product are only compatible with PCM signal (2-channel).
- The PHONO jacks of this product are compatible with MM cartridges. Use a step-up transformer or the like when connecting a turntable (record player) equipped with an MC (low-output) cartridge.
- For some turntables, connecting to the GND terminal of this product may reduce noise. However, there are also some turntables that have less noise if they are not connected to the GND jack.
- The GND terminal is not an electrical ground for safety purposes.

#### Related links

“Rear panel” (p.19)

## Connecting to your computer (USB DAC function)

---

This product is equipped with a USB DAC function. If you connect the USB port of this product to a computer, you can enjoy the high quality sound of music files on the computer, thanks to the analog conversion process used by the DAC device of this product. In order to use this function, first install the dedicated drivers (computer software) provided by Yamaha onto the computer, and then connect the computer to this product.

### ■ Compatible operating systems

The following computer operating systems (OS) are supported. (As of May 2023)

- Windows 10/11
- macOS 13/12/11/10.15/10.14/10.13

### ■ About the drivers (computer software)

If the OS of the computer is Windows, it is necessary to install the dedicated driver, “Yamaha Steinberg USB Driver”. If your computer’s OS is macOS, its standard drivers work, so no special driver needs to be installed.

#### NOTE

- Services may not work even on a “compatible OS” due to the computer’s configuration, the environment, and/or version updating of the OS.
- Install the driver on your computer before connecting this product to it. If you connect it before installing the software, it may not work properly.

### ■ Installing the dedicated driver (Windows only)

Before connecting this product to your computer, install the dedicated driver onto the computer.

#### **1 Access the following URL and search for “Yamaha Steinberg USB Driver”.**

Software downloads page

URL: <https://download.yamaha.com/>

#### **2 Download the latest driver.**

#### **3 Extract (uncompress) the downloaded files.**

#### **4 Install the driver onto your computer.**

To install the driver, follow the installation guide that came with the driver when you downloaded it.

#### **5 When installation is complete, close all applications that are running.**

#### NOTE

If an old version of the driver is already on your computer, uninstall it and then install the new driver.

## ■ Connect your computer

Connect a USB cable (commercially available) to this product and your computer. The USB port of this product is compatible USB Type B connectors.

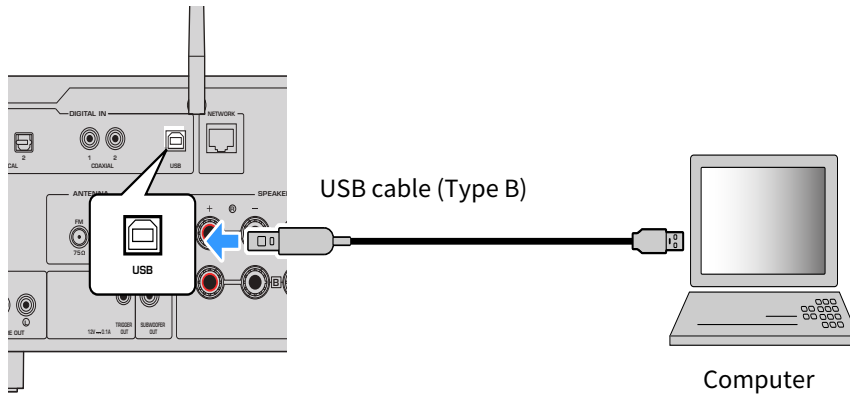

### NOTE

- After checking what kind of USB port your computer uses, get the appropriate USB cable (commercially available).
- Use a USB cable of less than 3 meters.

### Related links

“Playing audio from your computer (USB DAC)” (p.77)

## Connecting speakers

### Connecting speakers

Use speaker cable (commercially available) to connect speakers to the product.

#### ■ About speaker impedance

- Use the speakers with an impedance of at least 4-ohm.
- Use the speakers with an impedance of at least 8-ohm in the following case.
  - When connecting 2 sets of speakers (Speaker A and Speaker B), and outputting from both the A and B jacks (selecting the output speaker to A+B).
- When connecting 4-ohm (4-ohm or more but less than 8-ohm) speakers, change the speaker impedance on the Advanced Setup menu.

#### Related links

- “Selecting the output speakers” (p.52)
- “Switching speaker impedance” (p.113)

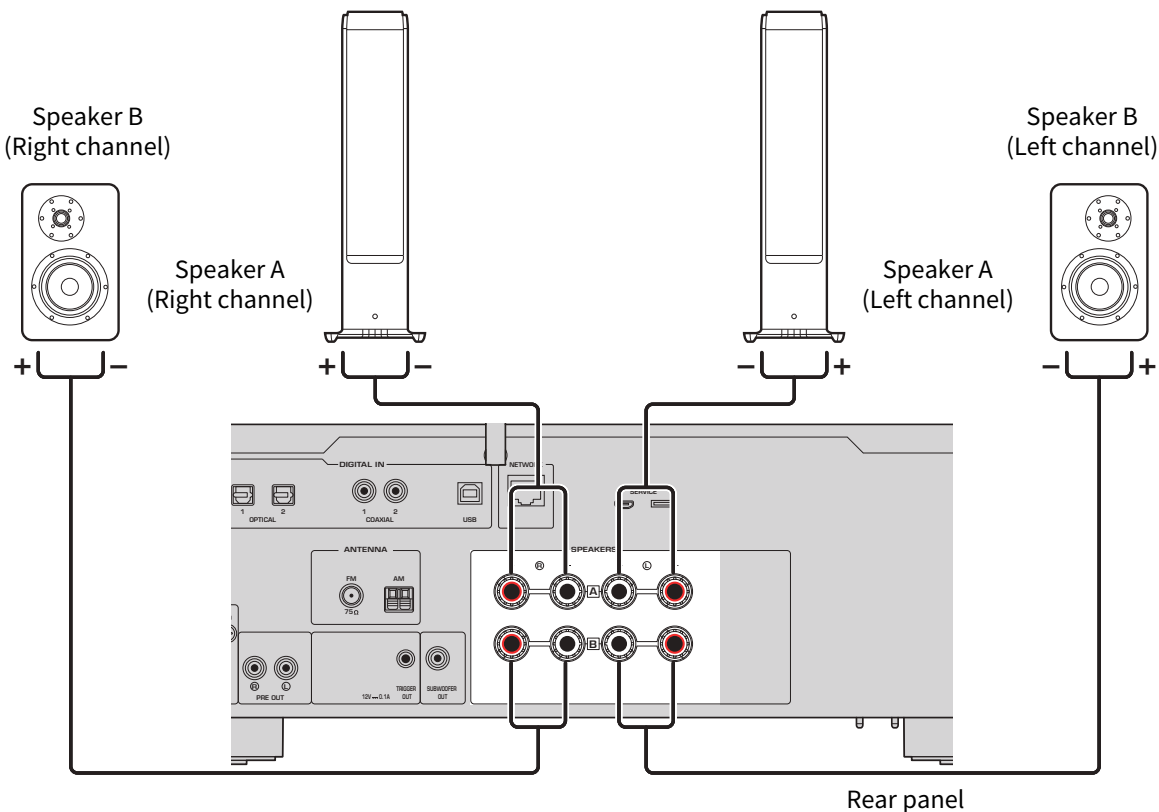

- 1 Peel off about 10 mm of insulation on the end of the speaker cable and twist its core tightly.**

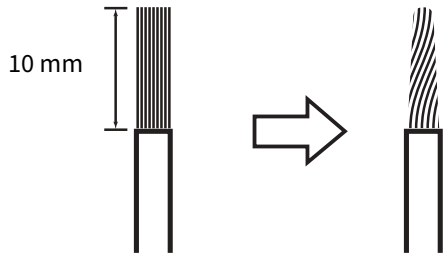

- 2 Turn the knob of the speaker jack to the left to loosen it, then insert the core of the speaker cable into the hole in the jack.**

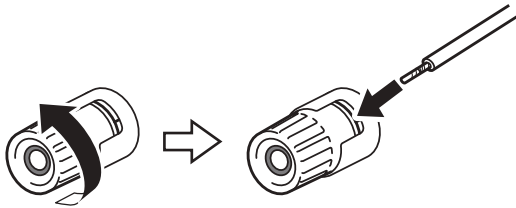

- 3 Turn the knob back to the right to tighten it.**



#### NOTICE

- When preparing the speaker cable, do so far away from the product. Pieces of the core wires of the speaker cable may fall inside the product and cause a short circuit, resulting in malfunction.
- Do not allow the core wires of a speaker cable to touch the core wires of another speaker cable or any metal parts of the product. Doing so may damage the product and/or the speakers.

#### NOTE

Be sure to connect to the jacks correctly: left channel (L), right channel (R) and + (red), - (black). If connected incorrectly, no audio may be output from the speakers. Also, if the polarity is wrong, the audio may sound strange.

#### ■ Connecting via banana plug (Models for U.S.A., Canada, China, Taiwan and for Central and South America)

When using a banana plug, tighten the knob of the speaker terminal and insert a banana plug into the end of the terminal.

## PREPARATION > Connecting speakers

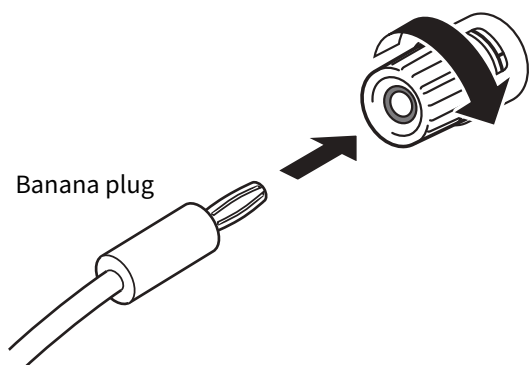

Banana plug

### Related links

- [“Making bi-wiring connections” \(p.31\)](#)
- [“Connecting a subwoofer” \(p.32\)](#)
- [“Switching speaker impedance” \(p.113\)](#)

## Making bi-wiring connections

Bi-wiring allows output to the speaker woofers (low frequency) and the tweeter/mid-range (mid to high-frequency) to be split and driven separately. Speakers compatible with bi-wiring are required for these connections.

- 1 Remove the short bar or bridge attached to the jacks of the speakers.**
- 2 Connect the product and the speakers as illustrated.**

The illustration shows connecting the left channel. Connect the right channel in the same way. Swapping the connections between speaker jacks A and B is OK.

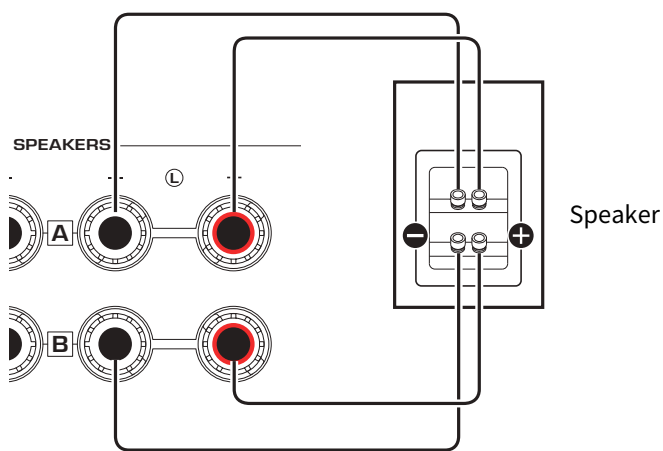

Rear panel

### NOTE

- If the system is connected with bi-wiring, turn ON both Speakers A and B by pressing the SPEAKERS A and SPEAKERS B keys when the power is ON.
- Use speakers with an impedance of at least 4  $\Omega$  and that are compatible with bi-wiring connections.

### Related links

- “Running YPAO” (p.44)
- “Selecting the output speakers” (p.52)

## Connecting a subwoofer

To use a subwoofer, connect it to the product with a monaural pin cable (RCA) (commercially available).

Subwoofer (with built-in amplifier)

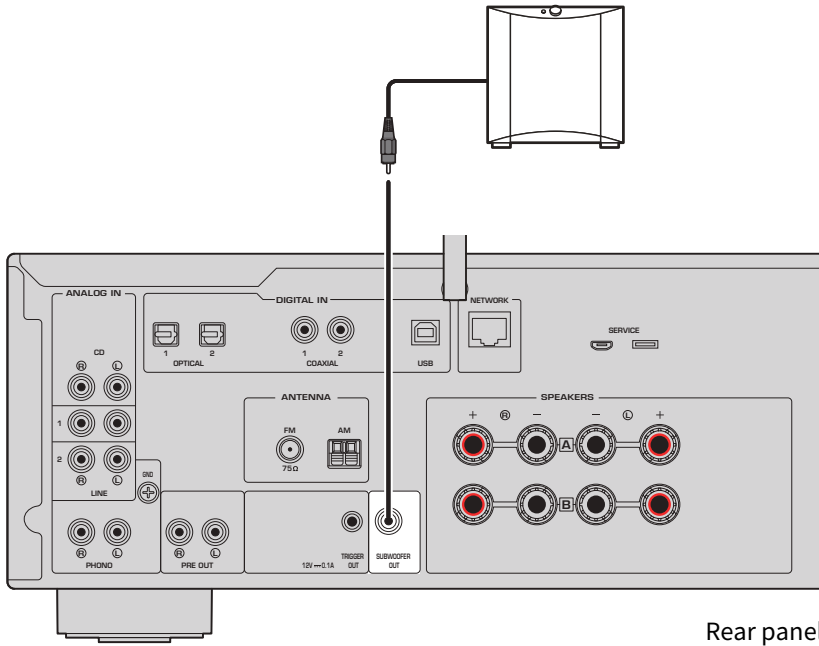

Rear panel



## Trigger connection

### Connecting a trigger-connection compatible Yamaha device

The trigger function allows external devices to be controlled linked with the operation (power ON/OFF) of this product. If you are using a Yamaha subwoofer that supports system connections, or a device with a Trigger IN jack, you can use the trigger function by connecting it to a TRIGGER OUT jack of this product via a mono mini-plug cable.

When this product is turned ON, it outputs a signal (12 V, 0.1 A) from the TRIGGER OUT jacks, linking them.

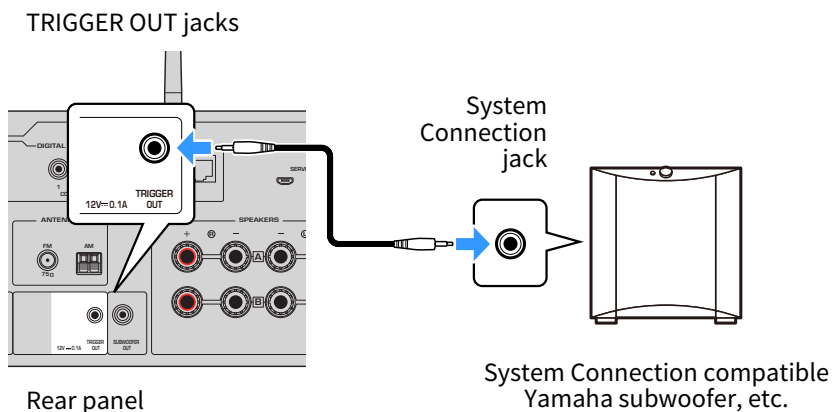

#### NOTE

On some Yamaha subwoofers, the trigger connection may be called “System Connection”.

## Connecting radio antennas

### Connecting an FM antenna

**Model For**

U.S.A., Canada, China, Korea, Asia, Taiwan, Central and South America

Connect the included FM antenna to the product.

After connecting the FM antenna, secure it to a wall.

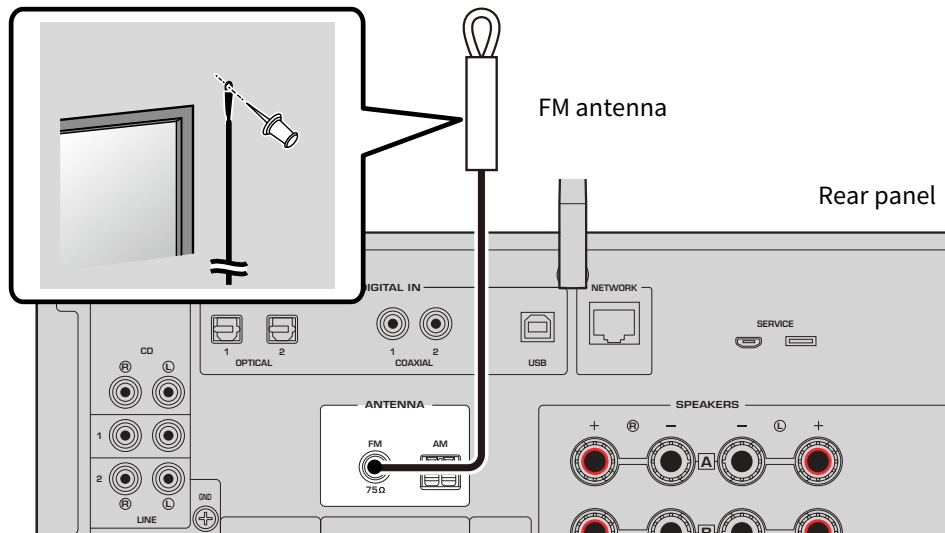

## Connecting an AM antenna

### Model For

U.S.A., Canada, China, Korea, Asia, Taiwan, Central and South America

Connect the included AM antenna to the product.

Put the AM antenna in a flat location after connecting it.

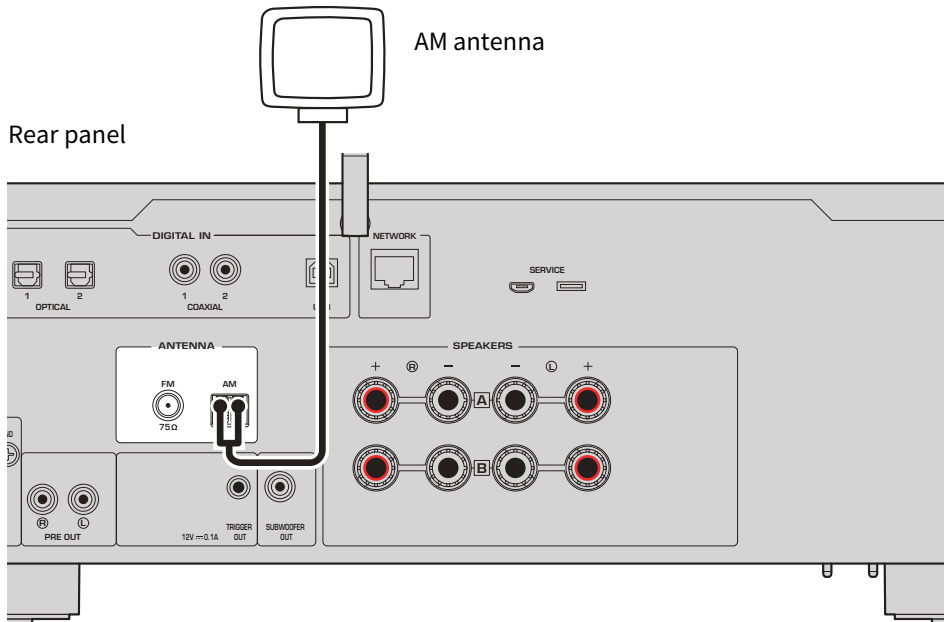

### Assembly and connection of the AM antenna

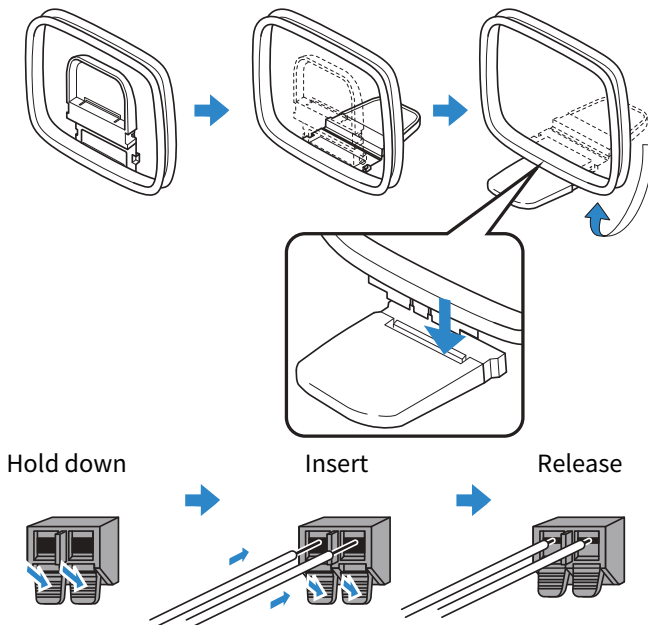

### NOTE

- Only unwind as much wire from the antenna unit as is required for wiring.
- The cord of the AM antenna does not have polarity.

## Connecting a DAB/FM antenna

### Model For

U.K., Europe, Russia and Australia

Connect the included DAB/FM antenna to the product.

Fix the antenna ends to a wall.

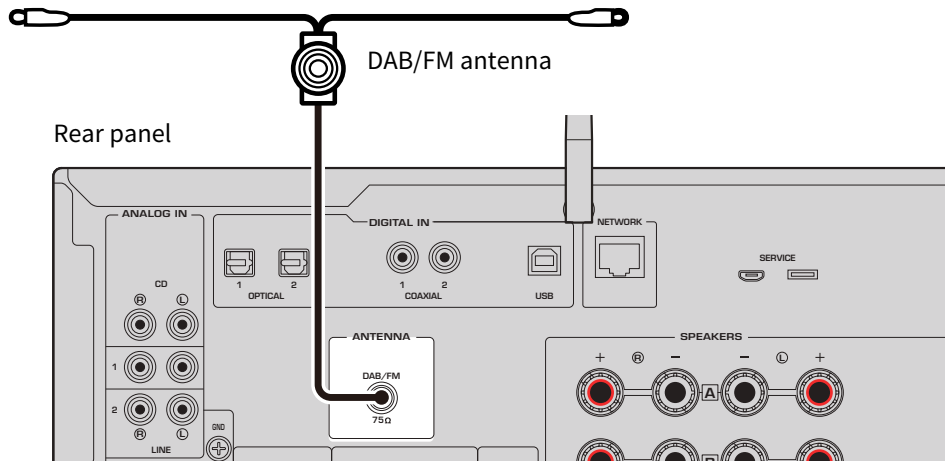

### NOTE

- The antenna should be stretched out horizontally.
- If you cannot obtain good reception on the radio, adjust the height, direction or placement of the DAB/FM antenna.

## Preparing a network connection

### To make a network connection

---

This product supports both wired and wireless connections.

Select the connection method according to your network environment.

Connecting to a network allows you to play Internet radio stations and music files stored on media servers such as computers or network-attached storage (NAS).

#### **NOTICE**

- When connecting the product to the Internet, be sure to connect via a router to ensure security. Set up an appropriate password for the router that it goes through. Do not connect directly to communication lines (including public LANs) of telecommunications carriers (mobile communication companies, fixed-line providers, Internet providers, etc.)

#### **Related links**

- “Connecting a network cable (wired connection)” (p.38)
- “Preparing the wireless antenna (wireless connection)” (p.39)

## Connecting a network cable (wired connection)

Use a network cable (CAT-5 or higher straight cable) (commercially available) to connect the product to the router.

If the router is compatible with DHCP servers, network settings do not have to be configured for this product.

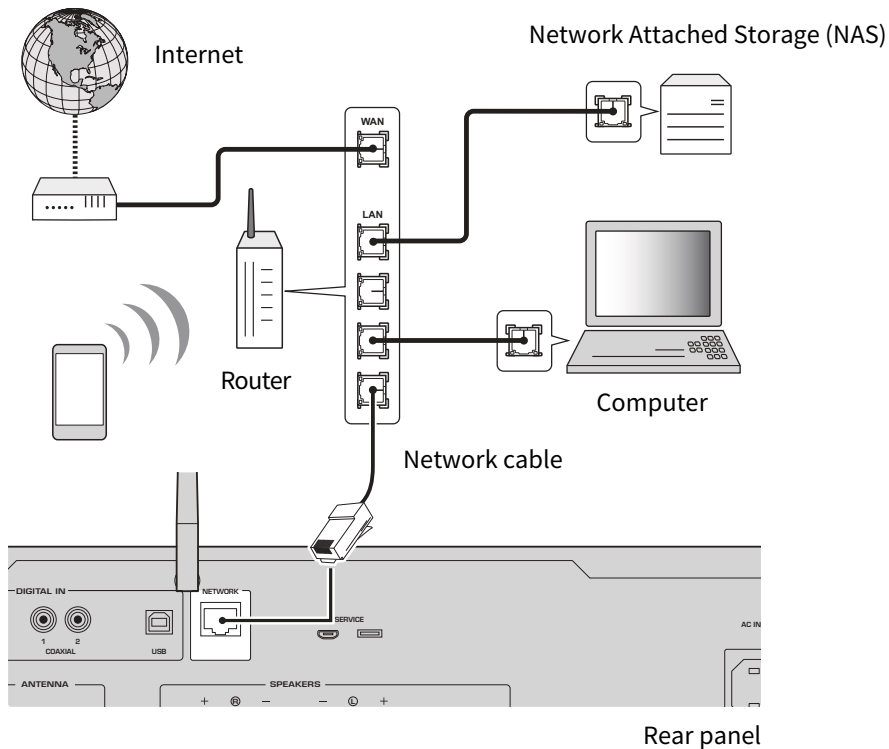

### NOTE

- If the router is not compatible with DHCP servers, or if you want to configure the network parameters manually, you must configure the network settings.
- Use STP (Shielded Twisted Pair) cable to prevent electromagnetic interference.

### Related links

“Configuring a network” (p.96)

## Preparing the wireless antenna (wireless connection)

To use a wireless or Bluetooth connection, flip up the wireless antenna.

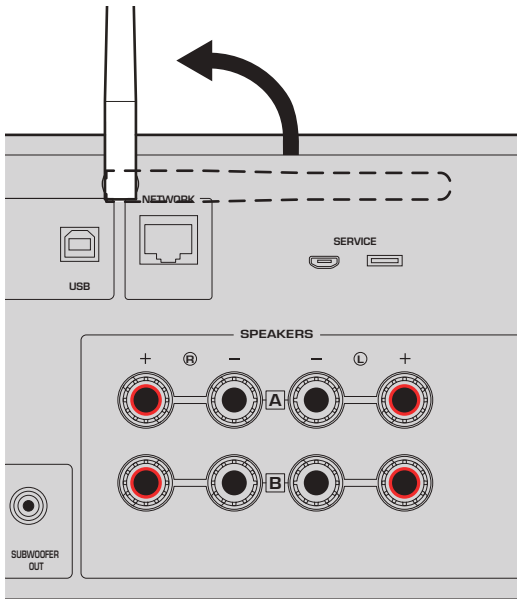

### NOTICE

- Do not exert excessive force on the wireless antenna. Doing so may damage it.

### Related links

- “Registering with the MusicCast network” (p.43)
- “Selecting the wireless method of connecting to the network” (p.134)

## Turning the product ON

### Connecting the power cord

After making all the connections, connect the included power cord.

Rear panel

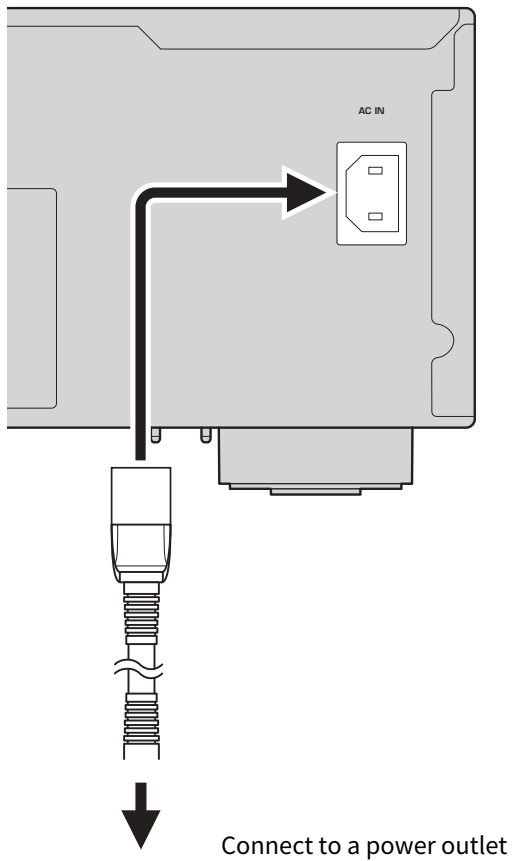

#### NOTE

Be sure to unplug this product from the power outlet when it will not be used for a long time. This product consumes a small amount of electricity even when its power is in Standby.



## Turning the power ON

Turn the product ON.

### 1 Press the (Power) Switch on the front panel.

The power comes ON and the Power Indicator lights up.

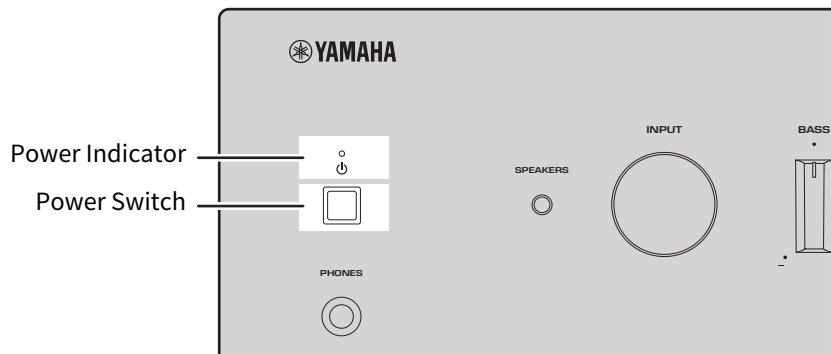

### 2 When the following message is shown on the front display, press RETURN on the front panel.

When you connect this product to the router with a network cable (wired connection), this operation is skipped.

It may take about 30 seconds for the message to be shown. The portion marked with “\*” varies depending on the device.

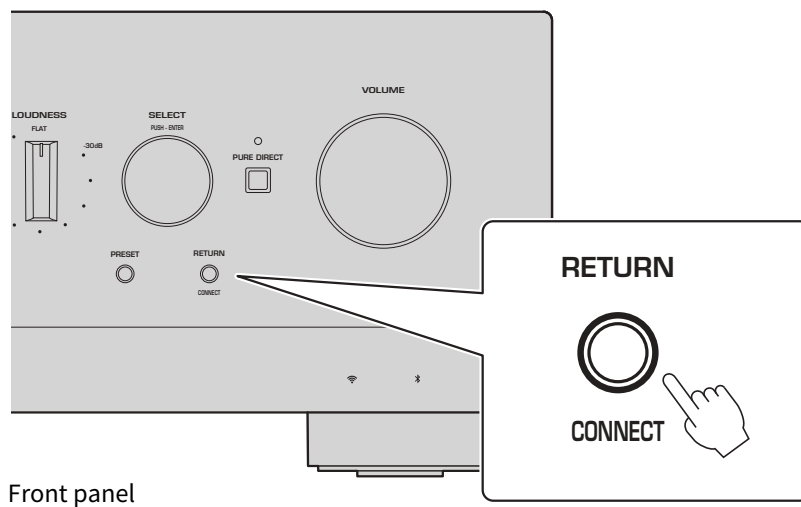
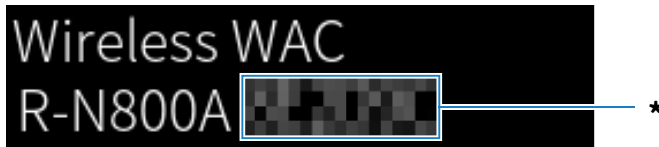

Front panel

### **“Wireless WAC” Display**

- The WAC (Wireless Accessory Configuration) function is for applying the wireless settings of an iOS device to another device and wirelessly connecting to the network. The steps for connecting to a network using MusicCast Controller are explained in the chapter “PREPARATION”. Therefore, how to cancel WAC is explained here.
- The WAC message is displayed the first time you use the product and after it is initialized.

### **NOTE**

- It takes several seconds from turning the power ON until audio is played.
- After turning the power OFF, do not try to turn it ON again for at least 10 seconds. Doing so may generate some noise.

### **Related links**

“Making a wireless connection with your iPhone (WAC)” (p.136)

## **■ Operating the power with the remote control**

When the ⏻ (Power) Switch on the front panel is ON, the product switches between ON/Standby each time the ⏻ (Power) key on the remote control is pressed.

### **NOTE**

When the product's power is in Standby, to turn the power ON without using the remote control, press the ⏻ (Power) Switch to turn it OFF momentarily, and then press it again to turn it ON again.

## Configuring MusicCast settings (connecting to a network)

### Registering with the MusicCast network

Register the product to the MusicCast network. You can configure network connection settings for the product at the same time. The dedicated app “MusicCast Controller” for mobile devices is required for making settings. Find “MusicCast Controller” (free) in the App Store or Google Play and install it.

- 1 Start “MusicCast Controller” on your mobile device(s) and tap “Setup”.**
- 2 Follow the instructions provided by “MusicCast Controller”.**

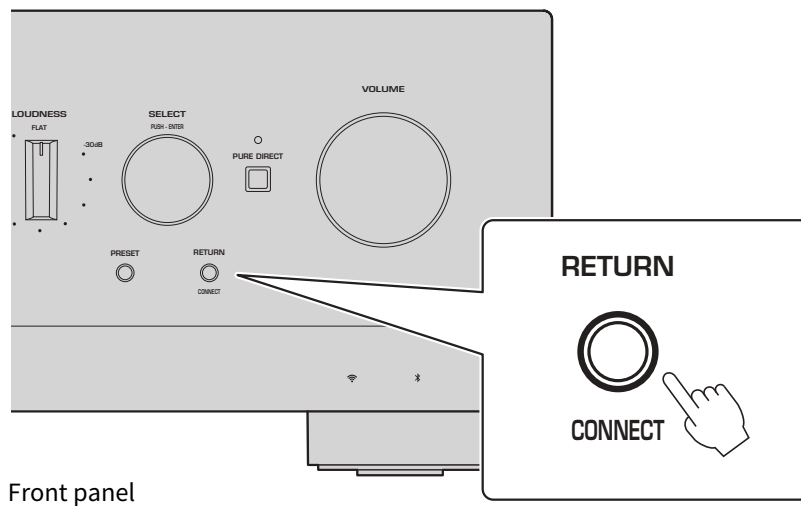

#### NOTE

- To connect to the network wirelessly, ensure that you have the SSID and security key of the wireless LAN router (access point) you wish to use.
- To configure a second and subsequent MusicCast-compatible devices, tap “Settings” > “Add New Device” in “MusicCast Controller”.

#### Related links

“Configuring a network” (p.96)

## Automatic adjustment of speaker settings (YPAO)

### Running YPAO

To run YPAO, the included YPAO microphone must be used.

YPAO is a function that adjusts acoustic characteristics such as volume balance by detecting speaker connections and the distance between your listening position and the speakers. This function can be applied either to speakers directly connected to the speaker jacks of this product, or to speakers driven by an external amp connected to the PRE OUT jacks.

#### NOTE

- YPAO makes loud sounds while it is running. The volume cannot be adjusted.
- To ensure correct YPAO adjustment, pay attention to the following while it is running.
  - Do not make any loud noises.
  - Do not get in between the speakers and the YPAO microphone.
- Do not plug in headphones.
- If you change the speaker's configuration, such as replacing a speaker or adding/removing a subwoofer, be sure to run YPAO again.

### 1 On the front panel, check the following before running YPAO.

- BASS and TREBLE are in their center positions.
- BALANCE is in its center position.
- LOUDNESS is in its center position (FLAT).
- PURE DIRECT is OFF.

### 2 Press the **SPEAKERS A** key and/or **SPEAKERS B** key to select the speakers to use.

- If they are connected with bi-wiring, turn ON both Speakers A and B (A+B).
- When using an amplifier connected to the PRE OUT terminal, turn OFF both Speakers A and B.

#### NOTE

This operation can be done also with SPEAKERS on the front panel.

### 3 If a subwoofer will be used, turn its power ON and adjust the volume to its midpoint.

If the crossover frequency can be adjusted, set it to the maximum.

If a subwoofer will not be used, go to the next step.

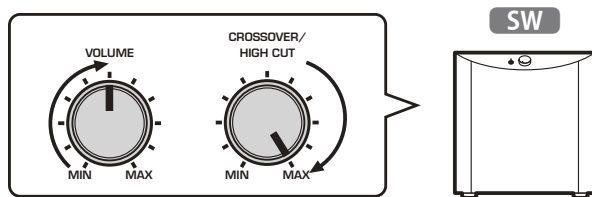

#### NOTE

The actual subwoofer volume and crossover frequency are set by the YPAO function of this product. However, during Pure Direct playback, they follow the subwoofer's setting. When using Pure Direct, adjust the subwoofer volume and crossover frequency to your favorite value, and then run YPAO.

**4 Put the included YPAO microphone in the listening position (ear height).**

Secure the YPAO microphone in place so it does not move. If a camera tripod is used for the microphone, its screws can be used to secure the microphone.

**5 Plug the YPAO microphone into the YPAO MIC jack on the front panel.**

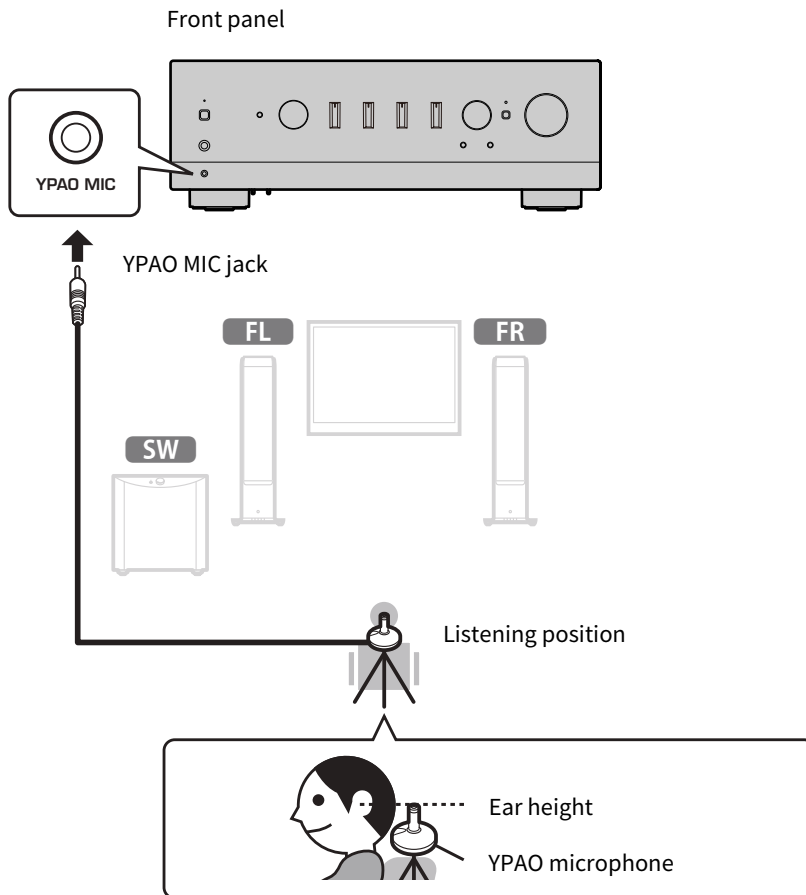

The following message appears on the front display.

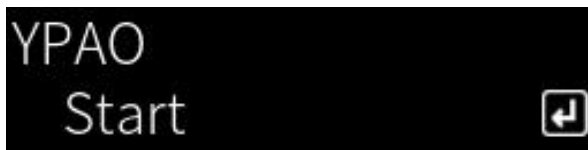

**NOTICE**

- Be careful not to stumble on the YPAO microphone cable. Doing so may damage the YPAO microphone.

## 6 Press the ENTER key to start YPAO making the automatic adjustments of speaker settings.

Adjustments start automatically after about 10 seconds. It takes about one minute.

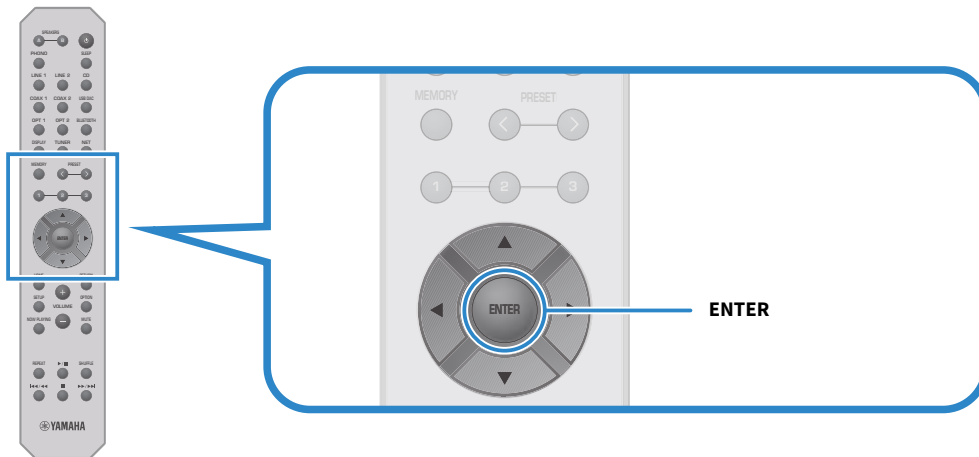

### NOTE

To cancel the operation before starting the YPAO function, unplug the YPAO microphone. After YPAO has started, press the RETURN key.

## 7 Check the results on the front display.

After all adjustments are complete, the results are shown on the front display. Follow the instructions and press the ENTER key to complete the adjustments.



## 8 Unplug the YPAO microphone from the YPAO MIC jack.

This completes the automatic adjustments of speaker settings via YPAO.

### NOTICE

- The YPAO microphone is sensitive to heat, so avoid hot places (such as on top of an external device) or places in direct sunlight when storing it.

### NOTE

- Running YPAO automatically enables the YPAO Volume function, which is linked to the volume and automatically adjusts the bass/treble balance. This allows you to enjoy a natural balance in sound quality, even at low volumes.
- Run the YPAO process for each set of speakers that will be used. Speaker settings are saved individually for each of the speakers used (A, B, A+B and Off).
- Error messages may be displayed during auto-adjustment, and/or warning messages may appear in the results.
- You can use the dedicated app "MusicCast Controller" to check the results of YPAO measurements and change the speaker settings.

**Related links**

- “Front panel” (p.13)
- “Error and warning messages” (p.48)
- “Using the app to check YPAO measurements and change settings” (p.50)
- “Configuring YPAO” (p.102)

## Error and warning messages

When error or warning messages are displayed, resolve the cause based on the following table and measure again.

[Search tag]#Q01 YPAO Error and Warning

### ■ Error Messages

Error Messages	Solution
<b>E-1:Noisy</b>	Measure again after making the room quiet.
<b>E-2:No Signal</b>	Plug the YPAO microphone securely into the YPAO MIC jack and measure again. If this error occurs frequently, contact the outlet where you bought this product, or the authorized Yamaha service center.
<b>E-3:No MIC</b>	Plug the YPAO microphone securely into the YPAO MIC jack and measure again.
<b>E-4:User Cancel</b>	Depending on your purpose, measure again or close YPAO.
<b>E-5:Headphone plugged</b>	Unplug the headphones and then measure again.
<b>E-10:Internal Err.</b>	After finishing YPAO, turn this product OFF and back ON. If this error occurs frequently, contact the outlet where you bought this product, or the authorized Yamaha service center.
<b>E-20:No Speakers</b>	Select the speakers to use (A, B, A+B or Off) and then measure again. If the same error message appears again, exit YPAO, turn OFF this product, and check the speaker and/or PRE OUT jack connections. If using an external amp, check its connections and power.
<b>E-21:Control Knob</b>	Make sure the controls on the front panel, BASS, TREBLE, BALANCE and LOUDNESS, are in the center or FLAT positions, and then measure again.
<b>E-22:Pure Direct</b>	Turn PURE DIRECT on the front panel OFF (indicator not lit) and then measure again.

### NOTE

- To exit YPAO in order to resolve the cause, press the ENTER key and then use the cursor keys (▲/▼) to select “Cancel” and press the ENTER key.
- To measure again, press the ENTER key and then use the cursor keys (▲/▼) to select “Retry” and press the ENTER key.

### ■ Warning Messages

Even when a warning message is displayed, the measurement results can still be saved. However, to get the best speaker settings, we recommend resolving the cause and running the measurements again.



Warning Messages	Solution
<b>W-1:Out of Phase</b>	<p>Check the cable connections (+ &amp; -) of the corresponding speakers.</p> <p><b>If connected incorrectly:</b> Reconnect the speaker cables.</p> <p><b>If connected correctly:</b> This message may appear even when everything is connected correctly, depending on the kind of speakers and installation environment. Save the settings and use the system as-is. (This message prompts you to check the system and it does not affect playing this product if used as-is.)</p>
<b>W-2:Over Distance</b>	<p>Check the distance between the listening position and the corresponding speakers.</p>
<b>W-3:Level Error</b>	<p>Correct the connections or placement of the corresponding speakers. Use the same or similar speakers with similar performance if possible.</p> <p>If there is a problem with a subwoofer, check that its volume is appropriate.</p>

**NOTE**

Turn OFF this product before reconnecting or relocating speakers.

## Using the app to check YPAO measurements and change settings

You can use the dedicated app “MusicCast Controller” to check the results of YPAO measurements and change the settings. Use a mobile device with “MusicCast Controller” installed on it to perform these steps. The screens shown in the following steps are examples when “Living Room” is set to the name of the room in which this product is installed.

- 1 Start “MusicCast Controller” on your mobile device(s), select the room in which this product is installed, and then tap the settings icon.**

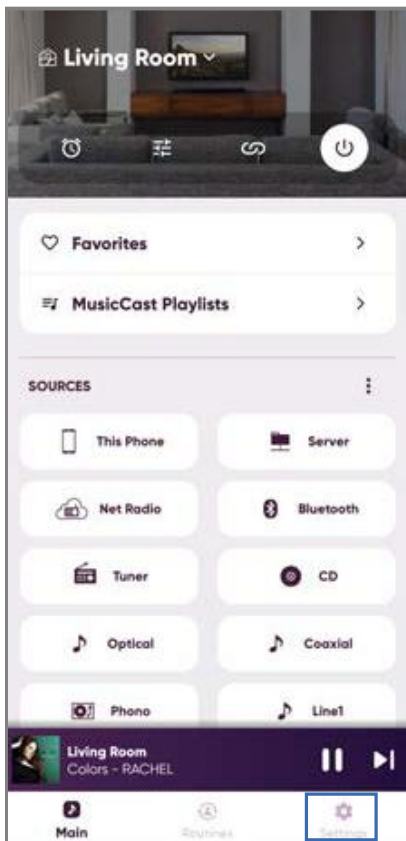

- 2 Tap the room in which this product is installed from “Room Settings” on the Settings screen.**
- 3 Tap “Speaker Setup” under “YPAO” on the room screen (this product).**
- 4 Confirm the YPAO measurement results on the Speaker Settings screen.**

You can also change the settings from the Speaker Settings screen.

Item	Setting Value or Display	Description
<b>Speakers</b>	A/B/A+B	Speaker being used is displayed. If neither A nor B is selected, the field is blank.
	No measurement	Shown if YPAO has not been run.
<b>Status</b>	Measuring...	Shown while YPAO is making measurements.

PREPARATION > Automatic adjustment of speaker settings (YPAO)

Item	Setting Value or Display	Description
<b>Status</b>	Not available	Displayed if YPAO measurements are not reflected in speaker settings.
	Available	Displayed if YPAO measurements are reflected in speaker settings.
<b>YPAO</b>	On/Off	Selects whether to reflect YPAO measurements in speaker settings.
<b>Subwoofer</b>	Use/Do not use	Sets whether to use/not use subwoofer.
<b>Speakers</b>	Full Band/Low Cut	Sets the frequency bandwidth output to the left/right speakers. If you select low frequency cut, the configured crossover frequency is applied.
		If a subwoofer will not be used, the setting cannot be made.
<b>Crossover</b>	40 Hz to 200 Hz	Sets the speaker and subwoofer crossover frequencies.
		If a subwoofer will not be used, the setting cannot be made.
<b>Distance</b>	L _____ 0.30 m to 24.00 m	Sets the distance from the listening position to each speaker individually so the sound from each of them reaches you at the same time.
	R _____ (0.05 m steps)	
	SW _____	
<b>Level</b>	L _____ -10.0 dB to +10.0 dB	Sets speakers individually so the volume from each sounds the same at the listening position.
	R _____ (0.5 dB steps)	
	SW _____	
<b>EQ</b>	On/Off	Sets whether to use/not use an equalizer based on YPAO measurements.
<b>YPAO Volume</b>	On/Off	When “YPAO Volume” is set to “On”, the balance between the bass and treble ranges is adjusted automatically in conjunction with the volume, which allows you to enjoy a natural sound quality balance, even at low volumes.

**NOTE**

If you will use a subwoofer, install it before running YPAO measurements to ensure a smooth connection between the bass and midrange. If you feel the volume of the bass is too loud or low, adjust to the desired volume with “SW” of “Level” item.

**Related links**

“Registering with the MusicCast network” (p.43)

# PLAYBACK

## Basic operations

### Selecting the output speakers

Press the SPEAKERS A key and/or SPEAKERS B key to select the speakers to output to.

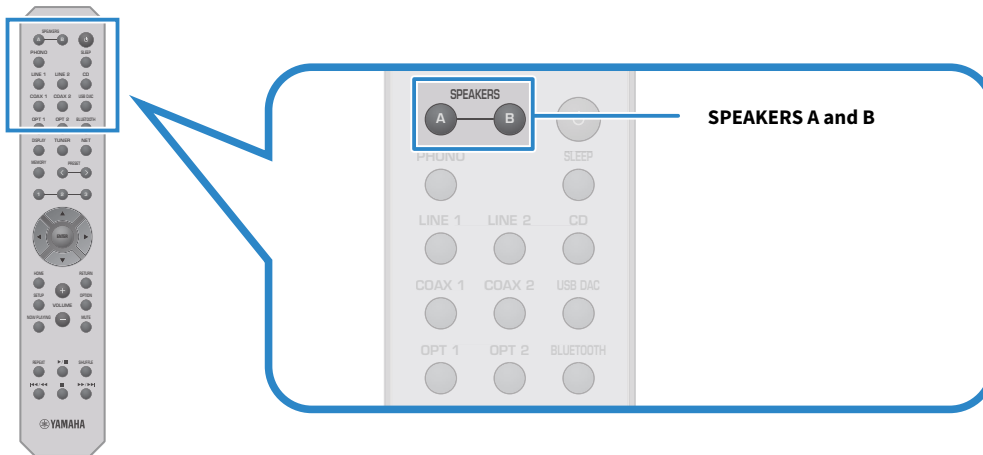

Switches Speakers A or B ON/OFF each time it is pressed. You can check which speakers are selected on the front display.

- A: Outputs from Speakers A.
- B: Outputs from Speakers B.
- A+B: Outputs from both Speakers A and Speakers B.
- Off: Does not output from either Speakers A or B.

#### NOTE

- This operation can be done also with SPEAKERS on the front panel.
- Regardless of the speaker selection, audio is always output to the PRE OUT jacks.
- If the speakers are connected with bi-wiring, select A+B.
- When headphones are connected, no audio is output from the speakers or PRE OUT jacks.

## Selecting an input source

To play music, select the desired input source.

- 1 Turn ON an external device.**
- 2 Press an input source selection key to select an input source.**

Selects the input source from the following.

- PHONO key: audio from turntable (record player) input via the PHONO jacks.
- LINE 1/2 keys: audio input via the LINE 1/2 jacks.
- CD key: audio input via the CD jacks.
- USB DAC key: computer audio input via the USB port.
- OPT 1/2 keys: audio input via the OPTICAL 1/2 jacks.
- COAX 1/2 keys: audio input via the COAXIAL 1/2 jacks.
- TUNER key: audio from a radio station.
- BLUETOOTH key: audio from a device, such as a smartphone, connected via Bluetooth.
- NET key: audio input via the NETWORK jack or wirelessly.

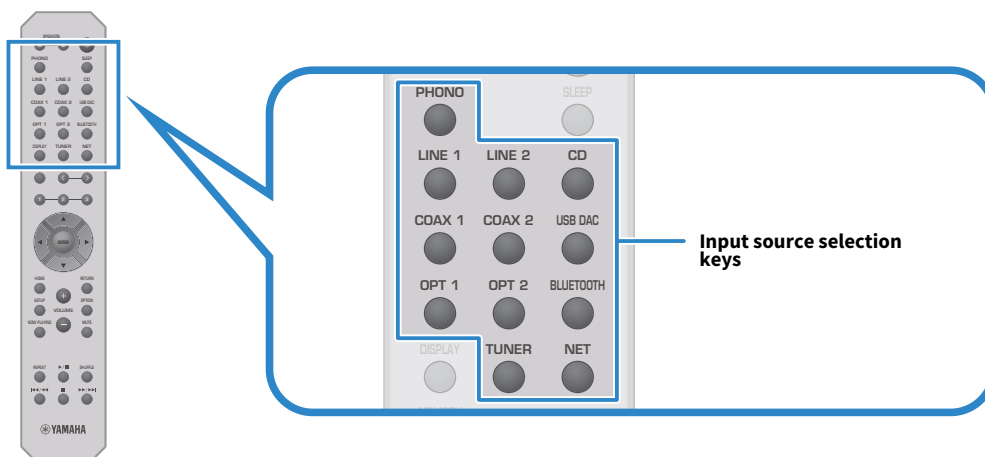

- 3 Operate an external device to start playback, or select a radio station with this product.**

### NOTE

- You can also turn INPUT on the front panel to select the input source.
- For information on operating your external device, refer to its operating manual.

## Adjusting the volume

Press the VOLUME +/- keys to adjust the volume.

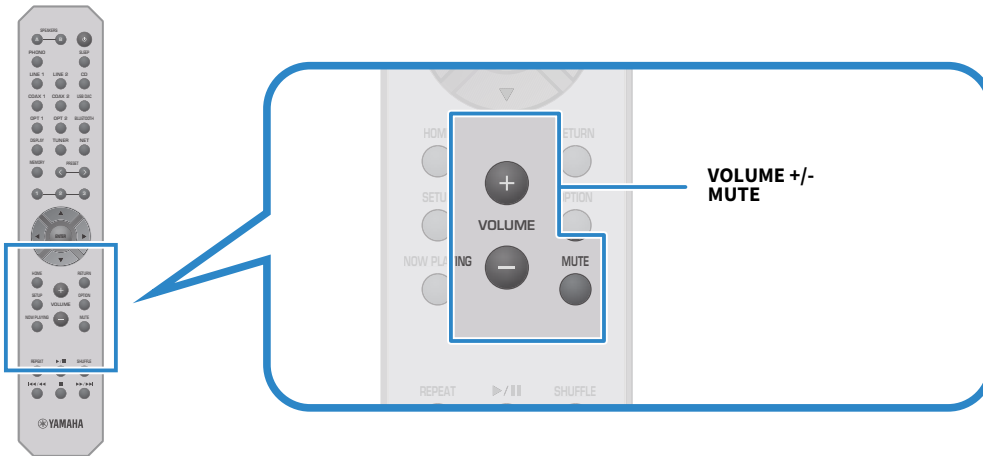

### NOTE

- You can also turn VOLUME on the front panel to adjust it.
- Pressing the MUTE key mutes the sound. Pressing it again returns the volume to its previous level.
- You can adjust the sound to your preference with BASS, TREBLE, BALANCE and LOUDNESS on the front panel.

### Related links

- “Adjusting bass and treble (BASS/TREBLE)” (p.57)
- “Adjusting left/right volume balance (BALANCE)” (p.58)
- “Making it easier to hear bass and treble at low volumes (LOUDNESS)” (p.59)

## Switching the front display

The information shown on the front display can be changed depending on the current input source. Repeatedly press the DISPLAY key of the remote control to select the desired display item.

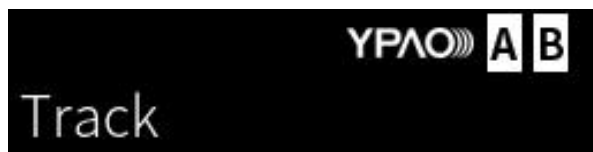

The selected information is displayed after 3 seconds.



The following display items are available.

Currently input source	Displayed item
<b>TUNER (FM/AM)</b>	Frequency (Models for U.K., Europe, and Russia) Radio Data System data is also available when this product is tuned into a Radio Data System broadcasting station. For details, see the following: <ul style="list-style-type: none"> <li>• “Displaying the Radio Data System information” (p.64)</li> </ul>
<b>TUNER (DAB)</b>	(Models for U.K., Europe, Russia, and Australia) For details, see the following: <ul style="list-style-type: none"> <li>• “Displaying the DAB information” (p.65)</li> </ul>
<b>Server AirPlay</b>	Track, Artist, Album, Time
<b>Net Radio</b>	Track, Album, Time, Station
<b>Bluetooth</b>	Track, Artist, Album

## Adjusting the sound to your preference

### Enjoying Pure Direct playback (PURE DIRECT)

---

Pure Direct stops various processes and circuitry except for the basic ones for playback, letting you enjoy higher quality sound with reduced noise.

Press PURE DIRECT to turn it ON, and the indicator lights up.

#### NOTE

- When using Pure Direct, the following functions are disabled.
  - The various adjustment functions: BASS, TREBLE, BALANCE, and LOUDNESS
  - Settings made via YPAO
  - Operation of Option menu and Setup menu
  - Indications on the front display (when no operations performed)
- When using Pure Direct, transmissions to the MusicCast Network are not available, except the audio of network content and Bluetooth devices.

#### Related links

“Using the app to check YPAO measurements and change settings” (p.50)



## Adjusting bass and treble (BASS/TREBLE)

---

You can adjust the level of high-frequency range (Treble) and low-frequency range (Bass) individually.

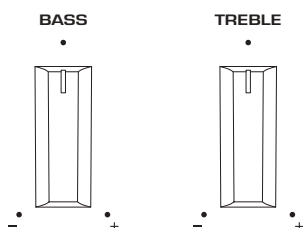

### ■ Adjusting the bass

When the bass feels too weak, turn BASS to the right to increase it. When it feels too strong, turn BASS to the left to reduce it.

It has flat characteristics when set to the middle.

Setting range: -10 dB to 0 to +10 dB (20 Hz)

### ■ Adjusting the treble

When the treble feels too weak, turn TREBLE to the right to increase it. When it feels too strong, turn TREBLE to the left to reduce it.

It has flat characteristics when set to the middle.

Setting range: -10 dB to 0 to +10 dB (20 kHz)

### NOTE

When Pure Direct is used, the settings are disabled (left and right channels are fixed at 0 dB).

## Adjusting left/right volume balance (BALANCE)

---

Any unbalance in volume due to positioning of the speakers and/or conditions in the room can be corrected by adjusting the balance of the volume between the left and right speakers.

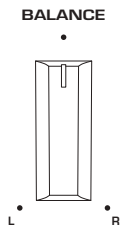

Turn BALANCE left or right to adjust the left channel (L) or the right channel (R). When turned all the way to the left or right, it mutes the opposite channel.

### NOTE

When Pure Direct is used, the setting is disabled (left and right channels are fixed at 0 dB).

## Making it easier to hear bass and treble at low volumes (LOUDNESS)

It lowers the volume of the midrange and allows the listener to enjoy natural sound even at low volumes by compensating for the human auditory characteristic that makes it difficult to hear bass and treble at low volumes.



### CAUTION

- If you enable Pure Direct after adjusting LOUDNESS, the input signal bypasses the loudness adjustment function and the volume increases suddenly. To protect your ears and the speakers from damage, always check the state of LOUDNESS before enabling Pure Direct, and if it is set to any position other than FLAT, lower the volume.

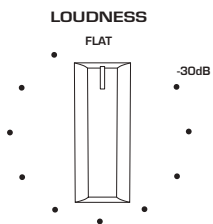

**1 Put LOUDNESS to the FLAT position.**

**2 Turn VOLUME up to the maximum level at which you normally listen to music.**

**3 Turn LOUDNESS counterclockwise to a moderate volume.**

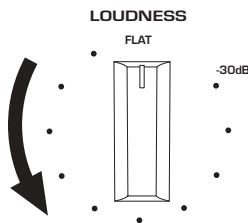

### NOTE

- If the YPAO Volume function is enabled, loudness adjustment cannot be used.
- When Pure Direct is used, the settings are disabled (equivalent to the FLAT position).
- After making the settings, if the loudness effect is too strong (or weak) when played at your desired volume, adjust it again.

## Listening to the radio

### Preparing to listen to the radio

---





#### Setting the frequency steps

##### Model For

Asia, Taiwan, Central and South America

Set the radio tuning frequency steps of this product depending on your country or region.

At the factory, the frequency step setting is set to 50 kHz for FM and 9 kHz for AM. Depending on your country or region, set the frequency steps to 100 kHz for FM and 10 kHz for AM.

- 1 Push the  (Power) Switch on the front panel to turn the power OFF.**
- 2 While pressing RETURN on the front panel, push the  (Power) Switch.**
- 3 Turn SELECT on the front panel to choose “Frequency Step” and press SELECT.**
- 4 Turn SELECT to choose “FM100/AM10” and press SELECT.**
- 5 Push the  (Power) Switch to turn it OFF.**
- 6 Push the  (Power) Switch again to turn it back ON.**

This completes the settings.

##### NOTE

Preset (registered radio stations) and frequency will be initialized if you change the radio tuning frequency steps.

##### Related links

[“Changing the FM/AM tuning frequency setting” \(p.111\)](#)

## Preparing the DAB tuning

### Model For

U.K., Europe, Russia and Australia

Before listening to DAB (Digital Audio Broadcasting) radio, perform an initial scan to register the DAB radio stations automatically.

- 1 Switch the input to “TUNER”.**
- 2 Press the TUNER key to select the DAB band.**

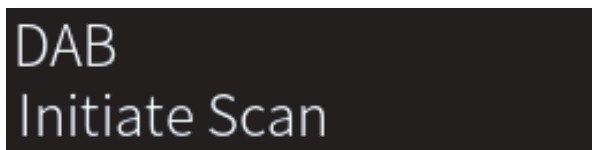

After 3 seconds, the initial scan starts. When the initial scan finishes, this product automatically tunes in to the first DAB radio station in order by frequency.

### NOTE

- DAB uses digital signals for clearer sound and more stable reception compared to analog signals. This product can also receive DAB+ (an upgraded version of DAB) that allows for more stations using MPEG-4 HE-AAC v2 audio codec, which has a more efficient transmission method.
- Be sure to check the DAB coverage in your area in that not all areas are currently being covered. For a list of nationwide DAB statuses and worldwide DAB frequencies, check WorldDMB online at <http://www.worlddab.org/>.
- If no DAB radio stations are found by an initial scan, the front display will change to “Off Air”.
- To perform an initial scan again after some DAB radio stations are stored, select “Init Scan” in the Option menu. If you perform an initial scan again, the DAB radio stations currently registered to the preset numbers will be cleared.
- You can check reception strength of each DAB channel label. Select “Tune AID” in the Option menu.

### Related links

- “Checking reception strength of each DAB channel label” (p.84)
- “Performing an initial scan for DAB radio reception” (p.83)

## ■ DAB frequency information

This product supports Band III (174 to 240 MHz) only.

Frequency	Channel label
174.928 MHz	5A
176.640 MHz	5B
178.352 MHz	5C
180.064 MHz	5D
181.936 MHz	6A
183.648 MHz	6B
185.360 MHz	6C
187.072 MHz	6D

## PLAYBACK &gt; Listening to the radio

<b>Frequency</b>	<b>Channel label</b>
188.928 MHz	7A
190.640 MHz	7B
192.352 MHz	7C
194.064 MHz	7D
195.936 MHz	8A
197.648 MHz	8B
199.360 MHz	8C
201.072 MHz	8D
202.928 MHz	9A
204.640 MHz	9B
206.352 MHz	9C
208.064 MHz	9D
209.936 MHz	10A
211.648 MHz	10B
213.360 MHz	10C
215.072 MHz	10D
216.928 MHz	11A
218.640 MHz	11B
220.352 MHz	11C
222.064 MHz	11D
223.936 MHz	12A
225.648 MHz	12B
227.360 MHz	12C
229.072 MHz	12D
230.784 MHz	13A
232.496 MHz	13B
234.208 MHz	13C
235.776 MHz	13D
237.488 MHz	13E
239.200 MHz	13F

## Selecting a radio station

---

You can use the this product's built-in tuner to listen to the radio.

### 1 Switch the input to “TUNER”.

The currently selected frequency is shown on the front display.



### 2 Press the TUNER key to switch to the next reception band.

- FM/AM (Models for U.S.A., Canada, China, Korea, Asia, Taiwan and for Central and South America)
- DAB/FM (Models for U.K., Europe, Russia and Australia)

### 3 Select a radio station.

- To specify a frequency and select a radio station, press the cursor keys (◀/▶) repeatedly. You can also search for stations automatically by long-pressing the cursor keys (◀/▶).
- To select a registered radio station, press the PRESET key and choose the desired preset number. To go back to selecting stations via frequency, press the RETURN key.

#### NOTE

- The FM radio reception mode (stereo/mono) can be set via “FM Mode” in the Option menu. When reception of an FM radio is unstable, it may help to switch to mono reception.
- You can check reception strength of each DAB channel label. Select “Tune AID” in the Option menu.

#### Related links

- “Auto-registering FM radio stations (auto preset)” (p.66)
- “Registering radio stations manually” (p.67)
- “Setting the reception mode (stereo/mono) for FM radio” (p.82)
- “Checking reception strength of each DAB channel label” (p.84)

## Displaying the Radio Data System information

---

### Model For

U.K., Europe and Russia

Radio Data System is a data transmission system used by FM stations. This product can receive various types of data, such as “Program Service”, “Program Type”, “Radio Text” and “Clock Time”, when it is tuned in to a Radio Data System broadcasting station.

- 1 Tune in to the desired Radio Data System broadcasting station.**
- 2 Press the DISPLAY key on the remote control to select between the various display items.**

The information appears on the front display.

<b>Frequency</b>	Frequency
<b>Program Service</b>	Program service name
<b>Program Type</b>	Current program type
<b>Radio Text</b>	Information on the current program
<b>Clock Time</b>	Current time

### NOTE

- “---” is displayed in “Program Service”, “Program Type”, “Radio Text”, and “Clock Time” if the radio station does not provide the Radio Data System service.
- We recommend using “Auto Preset” to tune in to the Radio Data System broadcasting stations.

### Related links

“Auto-registering FM radio stations (auto preset)” (p.66)



## Displaying the DAB information

---

### Model For

U.K., Europe, Russia and Australia

This product can receive various types of DAB information when it is tuned into a DAB radio station.

- 1 Tune in to the desired DAB radio station.**
- 2 Press the DISPLAY key on the remote control to select between the various display items.**

The information appears on the front display.

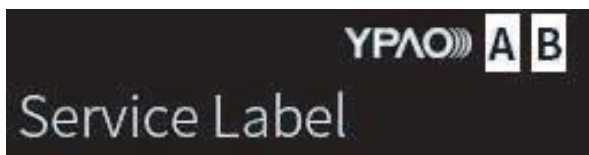

<b>Service Label</b>	Station name
<b>Dynamic Label</b>	Information on the current station
<b>Ensemble Label</b>	Ensemble name
<b>Program Type</b>	Station genre
<b>Date and Time</b>	Current date and time
<b>Audio Mode</b>	Audio mode (monaural/stereo) and bit rate
<b>CH Label/Frequency</b>	Channel label and frequency
<b>Signal Quality</b>	Signal reception quality (0 [none] to 100 [best])

### NOTE

Some information may not be available depending on the selected DAB radio station, and “---” is displayed.

## Auto-registering FM radio stations (auto preset)

---

This function automatically registers the FM stations with the strongest signal to preset numbers.

- 1 Switch the input to “TUNER”.**
- 2 Switch the reception band to FM.**
- 3 Press the OPTION key.**
- 4 Select “Auto Preset” with the cursor keys (▲/▼) and then press the ENTER key.**
- 5 Use the cursor keys (▲/▼) to select a preset number for starting the auto preset process.**
- 6 Press the ENTER key.**

Auto presetting begins and “Searching” is shown during the auto preset process.

Once auto preset is complete, “Finished” is displayed and the Option menu closes automatically.

### NOTE

- A maximum of 40 radio stations can be registered.
- To cancel auto preset, press the RETURN key.
- (Models for U.K., Europe and Russia) Only Radio Data System broadcasting stations are registered automatically by the Auto Preset function.

### Related links

- “Selecting a radio station” (p.63)
- “Registering radio stations manually” (p.67)

## Registering radio stations manually

---

You can select a radio station and register it manually to a preset number.

**1 Select a radio station.**

**2 Press the MEMORY key.**

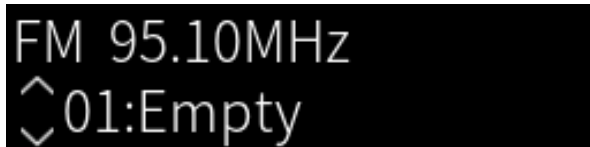

**3 Press the PRESET key and select the preset number to register.**

**4 Press the MEMORY key.**

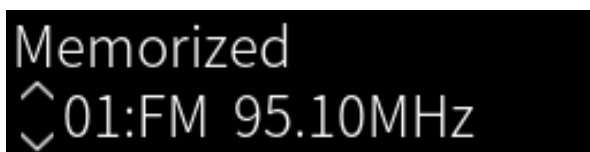

This completes the registration.

### NOTE

- A maximum of 40 radio stations can be registered.
- To register a radio station to the next empty number from the previously preset number, press the MEMORY key for 3 seconds or so while on the desired radio station.
- To go back to the original screen without registering, press the RETURN key.
- After 30 seconds of inactivity, the display automatically returns to the previous screen.

### Related links

- "Selecting a radio station" (p.63)
- "Auto-registering FM radio stations (auto preset)" (p.66)

## Removing the registration of a radio station

---

This explains how to remove the registration of a preset radio station.

- 1** Switch the input to “TUNER”.
- 2** Press the **OPTION** key.
- 3** Select “Clear Preset” with the cursor keys (▲/▼) and then press the **ENTER** key.
- 4** Press the **PRESET** key, select the preset number to remove, and then press the **ENTER** key.  
Once the registration is removed, “Cleared” is displayed and the next registered preset number is displayed.
- 5** To remove another preset number, repeat step 4.
- 6** Press the **OPTION** key.

This completes removal of the registration.

## Playing via a Bluetooth® connection

### Playing the audio of a Bluetooth device on this product (audio reception)

This product can play music files and the like saved on a Bluetooth device (such as a smartphone).



#### CAUTION

- If you adjust the volume on the Bluetooth device, it may get unexpectedly loud and cause damage to your hearing and/or equipment. If the volume becomes too loud during playback, stop playback immediately.

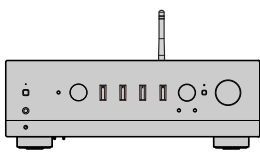

This product



Bluetooth device  
(smartphone, etc.)

- 1 Switch the input to “Bluetooth”.**
- 2 Select this product (network name of this product) on the Bluetooth device.**  
If a passkey is required, enter the number “0000”.
- 3 Play the audio of the Bluetooth device.**

#### NOTE

- If a paired Bluetooth device is detected, the input switches and the device is connected automatically. To connect to a different Bluetooth device, first disconnect the current connection.
- Use the playback keys on the remote control to control playback on the Bluetooth device.
- The volume on this product can be controlled from the Bluetooth device while it is playing (some Bluetooth devices may not be possible to control the volume).
- To disconnect the Bluetooth device, do any of the following.
  - Perform a disconnect operation on the Bluetooth device.
  - Press the BLUETOOTH key for 3 seconds (it may take some time to disconnect).
  - Switch the input of this product to anything other than “Bluetooth”.
  - Switch “Bluetooth” on the Setup menu to “Off”.
- The Bluetooth indicator on the front panel lights up when a Bluetooth device is connected.
- You can switch the playback information shown on the front display by repeatedly pressing the DISPLAY key while it is playing.

#### Related links

- “Configuring Bluetooth” (p.101)
- “Setting volume interlock with this product when playing an AirPlay/Bluetooth device” (p.85)
- “Switching the front display” (p.55)

## Playing this product's audio through Bluetooth speakers/headphones (audio transmission)

---

You can output the audio playing on this product to Bluetooth speakers/headphones.

Only connect to Bluetooth speakers/headphones that have volume adjustment. This product cannot adjust their volume.

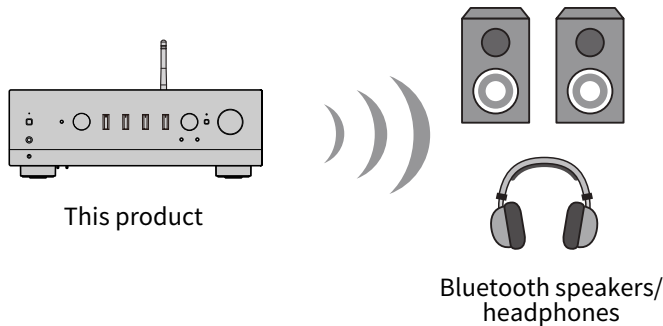

- 1 Select an input other than “Bluetooth”.**
- 2 Put the Bluetooth speakers/headphones that you wish to connect into pairing mode.**
- 3 Select the input source with the MusicCast Controller app.**
- 4 Tap the Settings icon on the playback screen.**
- 5 Tap “Bluetooth Transmission” on the Sound Settings screen.**
- 6 Turn “Bluetooth transmission” on from the Bluetooth Transmission settings screen.**
- 7 Select the Bluetooth speakers/headphones to send to.**

Once the connection is complete, audio is output from the Bluetooth speakers/headphones.

### NOTE

- Adjust the volume on the connected Bluetooth device.
- The audio being played is also output from the speakers connected to this product.
- AirPlay, DSD, and PCM audio exceeding 192 kHz cannot be transmitted.
- When using Pure Direct, audio of input sources other than network content cannot be transmitted.
- Audio cannot be sent and received at the same time via the Bluetooth function.
- To disconnect the Bluetooth device, do any of the following.
  - Perform a disconnect operation on the Bluetooth device.
  - Switch the input of this product to “Bluetooth”.
  - Switch “Bluetooth” on the Setup menu to “Off”.
- The Bluetooth indicator on the front panel lights up when a Bluetooth device is connected.

PLAYBACK > Playing via a Bluetooth® connection

**Related links**

“Configuring Bluetooth” (p.101)

## Listening to music via AirPlay

### Playing music via AirPlay

You can play music and other content on this product via AirPlay. Tap (or click) the AirPlay icon on your iPhone or iTunes/Music and then select this product as the output destination.



#### CAUTION

- The volume may become louder than expected when adjusting it on your AirPlay device, which can cause damage to your hearing and/or your device. If the volume becomes too loud during playback, stop playback immediately.

#### Explanation of key operations: playback keys

- ▶/■ (Play/Pause) key: starts or pauses playback.
- ■ (Stop) key: stops playback.

#### NOTE

- You can set this product to turn ON automatically when your AirPlay device starts playing.
- You can change the network name of this product that is displayed on your AirPlay device.
- You can control the volume of this product from your AirPlay device during playback.
- You can switch the playback information shown on the front display by repeatedly pressing the DISPLAY key while it is playing.
- The product is compatible with AirPlay 2.
- For information about AirPlay, see Apple's official website.
- AirPlay audio cannot be transmitted to the MusicCast Network.

#### Related links

- "Configuring a network" (p.96)
- "Setting volume interlock with this product when playing an AirPlay/Bluetooth device" (p.85)
- "Switching the front display" (p.55)



## Listening to internet radio

### Selecting an internet radio station

When this product is connected to a network, you can select and play Internet radio stations.

#### 1 Press the NET key on the remote control repeatedly to switch the input to “Net Radio”.

The browse indication is shown on the front display.

#### 2 Select the content with the cursor keys and press the ENTER key.

It starts playing.

#### Explanation of key operations: playback keys

- ▶/■ (Play/Pause) key: starts playback (cannot pause).
- (Stop) key: stops playback.

#### Explanation of key operations: playback info

- NOW PLAYING key: shows playback information for the Internet radio station on the front display.
- DISPLAY key: press repeatedly during playback to switch the playback information shown on the front display.

#### Explanation of key operations: content-related

- Cursor keys: for selecting the Internet radio station, folders, etc. Pressing them during playback changes the front display to the browse indication, allowing other content to be selected.
- ENTER key: press when a folder is selected to move one level down. Press when an Internet radio station is selected to start playing it.
- RETURN key: displays one level up.
- HOME key: displays the very top level. Pressing this during playback changes the front display to the top level in the browse indication, allowing other content to be selected.

#### NOTE

- You can register your favorite content to presets and then recall it easily.
- Some Internet radio stations may not be available at all times.
- This function uses the airable.Radio service. airable is a service provided by the company airable GmbH. This service is subject to change, suspension, or termination without notice. Please note that the Yamaha Corporation is in no way responsible for this.

#### Related links

- “To make a network connection” (p.37)
- “Registering your favorite content to presets” (p.88)
- “Switching the front display” (p.55)

## Listening to streaming services

### Listening to streaming services

---

When this product is connected to a network, you can play content distributed by the various streaming services.

For information on supported streaming services, go to the product information pages of the Yamaha website or refer to the MusicCast Controller.

The following website also provides supplementary information about different streaming services.

<https://manual.yamaha.com/av/mc/ss/>

#### **NOTE**

- Some streaming services require a subscription to their paid services. For details on each service provider, see its official website.
- Streaming services are subject to change, suspension, or termination without notice. Please note that the Yamaha Corporation is in no way responsible for this.

#### **Related links**

- “Configuring a network” (p.96)
- “Registering with the MusicCast network” (p.43)

## Playing songs on media servers (PC/NAS)

### Playing songs on media servers (PC/NAS)

When this product is connected to a network, it can play music files saved on a media server connected to the same server.

#### NOTE

It is necessary to enable the media sharing setting on each device or media server software ahead of time. For more details, refer to the user's manual of each device and software.

#### 1 Press the NET key on the remote control repeatedly to switch the input to "Server".

The browse indication is shown on the front display.

#### 2 Select a media server with the cursor keys and then press the ENTER key.

#### 3 Select the content with the cursor keys and press the ENTER key.

Once you select a song, it starts playing.

#### Explanation of key operations: playback keys

- ▶/■ (Play/Pause) key: starts or pauses playback.
- ■ (Stop) key: stops playback.
- ◀◀/◀ (Skip/Rewind) key: skips to the beginning of the current song (continuous press to the previous song).
- ▶▶/▶▶ (Fast-Forward/Skip) key: skips to the beginning of the next song.
- REPEAT key: changes the playback mode to Repeat. Check the settings on the front display.
  - Off: disables Repeat mode.
  - One: plays the current song repeatedly.
  - All: plays all the songs on the album (or in the folder) repeatedly.
- SHUFFLE key: changes the playback mode to Shuffle. Check the settings on the front display.
  - Off: disables Shuffle mode.
  - On: plays all the songs on the album (or in the folder) in random order.

#### Explanation of key operations: playback info

- NOW PLAYING key: shows playback information on the front display for the song that is playing.
- DISPLAY key: press repeatedly during playback to switch the playback information shown on the front display.

#### Explanation of key operations: content-related

- Cursor keys: for selecting music files, folders, etc. Pressing them during playback changes the front display to the browse indication, allowing other content to be selected.

## PLAYBACK > Playing songs on media servers (PC/NAS)

- ENTER key: press when a folder is selected to move one level down. Press when a music files is selected to start playing it.
- RETURN key: displays one level up.
- HOME key: displays the very top level. Pressing this during playback changes the front display to the top level in the browse indication, allowing other content to be selected.

### **NOTE**

- You can configure it so this product turns ON automatically when you start playing music on the media server.
- If the audio is cut off when connected to a wireless network, connect to a wired network.
- Playback can be controlled from a digital media controller (DMC).
- You can register your favorite content to presets and then recall it easily.
- When playing music on a device such as a smartphone or tablet, the settings of the device for repeat, shuffle, etc. are followed, so setting these features on the product may not have an effect.

### **Related links**

- “Setting auto playback” (p.86)
- “Configuring a network” (p.96)
- “Registering your favorite content to presets” (p.88)
- “Supported file formats on this product (network)” (p.139)
- “Switching the front display” (p.55)

## Playing audio from your computer (USB DAC)

### Playing music that is on your computer

---

When this product is connected to a computer via USB cable, it can play music that is on the computer.

#### NOTE

It may be necessary to install drivers when connecting this product to a computer.

#### 1 Switch the input to “USB DAC”.

#### 2 Set the audio output destination of the computer to “Yamaha USB DAC”.

##### For Windows OS:

Start menu → Settings → System → Sound [Output]

##### For macOS:

System Preferences → Sound → [Output] tab

The method of configuration varies depending on the version of the OS.

#### 3 Play music on your computer.

Confirm that audio is being output from this product.

#### NOTE

- Some computer applications have independent settings for the output destination. In such case, check the settings of the application.
- Signal format information is displayed on the front display during playback. “---” is displayed when not playing or if the signal format is not supported.

### ■ Adjusting the volume

For better sound quality, set the volume on your computer to its maximum, and then gradually increase the volume on this product from the minimum until it reaches your desired level.

#### NOTE

- During playback, do not disconnect the USB cable, turn off this product, or switch the input. Doing so may result in product malfunction.
- If you wish to mute the sounds of your computer’s interface when playing music, change the settings of your computer.
- Music stored on your computer cannot be controlled via this product or its remote control. To control music saved on your computer, operate the computer.

#### Related links

- “Connecting to your computer (USB DAC function)” (p.26)
- “Playable formats using USB DAC” (p.140)

## Option menu (settings for each input source)

### Basic operation of the Option menu

---

You can set playback-related functions to suit the source that is currently playing. The basic operating methods of the Option menu are as follows.

**1 Press the OPTION key.**

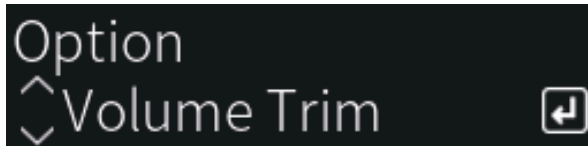

**2 Select a setting with the cursor keys and press the ENTER key.**

To go back a level of the menu, press the RETURN key.

**3 Select the desired setting with the cursor keys (◀/▶).**

**4 Press the OPTION key.**

This completes the configuration.

#### Related links

- “Menu structure” (p.93)
- “List of Option menu” (p.79)

## List of Option menu

---

The following settings are available in the Option menu.

Item		Page
<b>Volume Trim</b>	<b>Input Trim</b>	80
<b>Signal info</b>	<b>Format</b>	81
	<b>Sampling</b>	81
<b>Auto Preset</b>		66
<b>Clear Preset</b>		68
<b>FM Mode</b>		82
<b>Init Scan</b>		83
<b>Tune AID</b>		84
<b>Volume Interlock</b>		85
<b>Auto playback</b>		86
<b>PLL</b>		87

### NOTE

The settings available on the Option menu vary with the input source. Only the items that can be configured are shown on the front display.

## **Correcting volume difference between input sources**

---

You can correct volume difference between input sources. If it bothers you when the volume becomes louder/quieter when you change the input source, use this setting to fine tune them.

### **Option menu**

“Volume Trim” > “Input Trim”

### **Setting value**

-10.0 dB to +10.0 dB

### **NOTE**

Each input source can be set individually.

### **Related links**

“Basic operation of the Option menu” (p.78)



## Displaying audio signal information

---

### ■ Displaying format information

You can display format information for the audio signal that is playing.

#### Option menu

“Signal info” > “Format”

#### Related links

“Basic operation of the Option menu” (p.78)

### ■ Displaying the sampling frequency

You can display the sampling frequency of the audio signal that is playing.

#### Option menu

“Signal info” > “Sampling”

#### Related links

“Basic operation of the Option menu” (p.78)

## Setting the reception mode (stereo/mono) for FM radio

---

You can set the reception mode (stereo/mono) for FM radio. When reception of an FM radio is unstable, it may help to switch to mono reception.

### Option menu

“FM Mode”

### Setting value

Stereo	Receives FM radio in stereo.
Mono	Receives FM radio in mono.

### Related links

“Basic operation of the Option menu” (p.78)

## Performing an initial scan for DAB radio reception

---

### Model For

U.K., Europe, Russia and Australia

Performs an initial scan for searching DAB radio stations.

### Option menu

“Init Scan”

- 1 Select “TUNER” as the input source.**
- 2 Press the TUNER key to select the DAB band.**
- 3 Press the OPTION key.**
- 4 Use the cursor keys to select “Init Scan” and press the ENTER key.**
- 5 Press the ENTER key to start an initial scan.**

When the initial scan finishes, this product automatically tunes in to the first DAB radio station in order by frequency.

### NOTE

- If you perform an initial scan again, the DAB radio stations currently registered to the preset numbers will be cleared.
- If no DAB radio stations are found by an initial scan, press the ENTER key to start an initial scan again.

### Related links

“Basic operation of the Option menu” (p.78)

## Checking reception strength of each DAB channel label

---

### Model For

U.K., Europe, Russia and Australia

You can check reception strength of each DAB channel label.

### Option menu

“Tune AID”

- 1 Select “TUNER” as the input source.**
- 2 Press the TUNER key to select the DAB band.**
- 3 Press the OPTION key.**
- 4 Use the cursor keys to select “Tune AID” and press the ENTER key.**
- 5 Use the cursor keys to select the desired DAB channel label.**

The reception strength of DAB channel label is displayed in 0 (none) to 100 (best).

- 6 Press the OPTION key.**

This completes the checking.

### Related links

“Basic operation of the Option menu” (p.78)

## Setting volume interlock with this product when playing an AirPlay/Bluetooth device

---

When selecting an AirPlay/Bluetooth input, you can set whether to link the volume with this product. If set to anything other than Off, the volume of this product can be adjusted by the AirPlay or Bluetooth device.

### Option menu

“Volume Interlock”

### Setting value

Off	Disables volume control from AirPlay and Bluetooth devices.
Limited	Enables volume control to mute and within the range of -96.5 to -40.0 dB.
Full	Enables volume control to mute and within the range of -96.5 to 0.0 dB.

### NOTE

Volume interlock is not available on all Bluetooth devices.

### Related links

“Basic operation of the Option menu” (p.78)

## Setting auto playback

---

Sets whether to auto play media server content.

### Option menu

“Auto playback”

### Setting value

Off	Disables auto playback.
On	When the power is turned ON or the input is switched, the content that was last played starts playing automatically.

### NOTE

- The auto play settings are only available when the input is “Server”.
- Some inputs are always on auto play, such as Internet radio stations and Bluetooth devices.
- Auto playback may not work with some inputs or content.

### Related links

“Basic operation of the Option menu” (p.78)

## Improving intermittently disrupted sound from digital audio inputs

---

Change this setting if the input signal is unstable and the sound is intermittently disrupted. “Mode 3” has the best sound quality, while “Mode 1” is most resistant to clock fluctuations; the smaller the value, the less likely to be disrupted.

### Option menu

“PLL”

### Setting value

Mode 1, Mode 2, Mode 3

### NOTE

“PLL” settings are only available when the input is “OPTICAL1”, “OPTICAL2”, “COAXIAL1” or “COAXIAL2”.

### Related links

“Basic operation of the Option menu” (p.78)

# USEFUL FUNCTIONS

## Preset functions

### Registering your favorite content to presets

Registering your favorite content (media server songs, Internet radio stations, etc.) to presets or the 1/2/3 keys makes it easy to recall it later.

#### ■ Preset registration

“TUNER”, “Server”, “Net Radio” and some streaming services can be registered.

- 1 Select the radio stations you want to register, or play songs or Internet radio stations.**
- 2 Press the MEMORY key.**

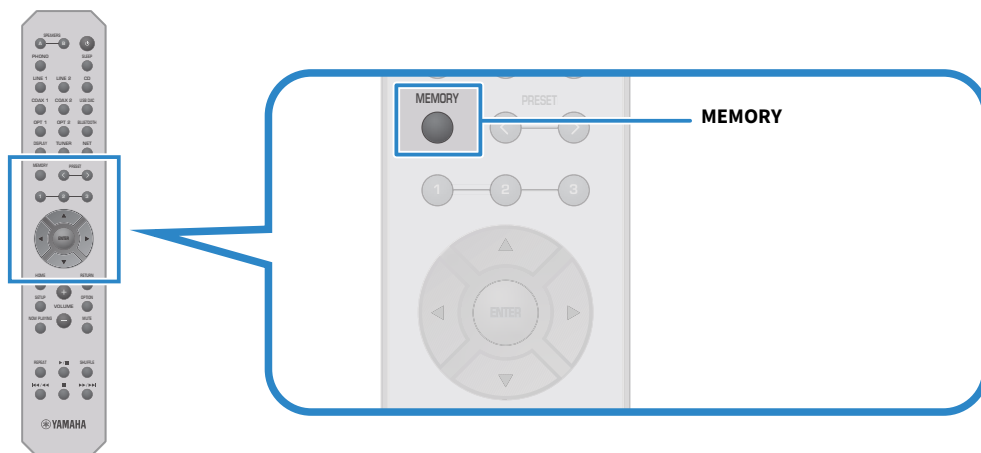

The preset number and content to register are shown on the front display. “Empty” is shown if not registered.

- 3 Press the PRESET key and select the preset number to register.**
- 4 Press the MEMORY key.**

The registered preset numbers and “Memorized” are shown.

This completes the registration.

#### NOTE

- By pressing the MEMORY key for 3 seconds or longer, you can register empty preset numbers automatically.
- To go back to the original screen without registering, press the RETURN key.
- A total of 80 pieces of content can be registered: 40 for “TUNER” and 40 for network content such as “Server”, “Net Radio”, etc.
- The type of content that can be registered may vary for streaming services and “Net Radio” according to the selected radio station or the service.



## ■ Registering a favorite (1/2/3 keys)

“TUNER”, “Server”, “Net Radio” and some streaming services can be registered.

**1 Select the radio stations you want to register, or play songs or Internet radio stations.**

**2 Press a numeric key (either 1/2/3) for 3 seconds or longer.**

If a favorite is already registered, it is overwritten.

This completes the registration.

### NOTE

- In addition to presets, favorites can be registered to each numeric key.
- If they cannot be registered, “Not Available” is shown on the front display.

## Recalling content registered to a preset

Select the content you want to listen to from the content (songs from a media server or Internet radio) registered to presets and/or the 1/2/3 keys.

### ■ Recalling a preset

#### 1 Press the TUNER key or the NET key.

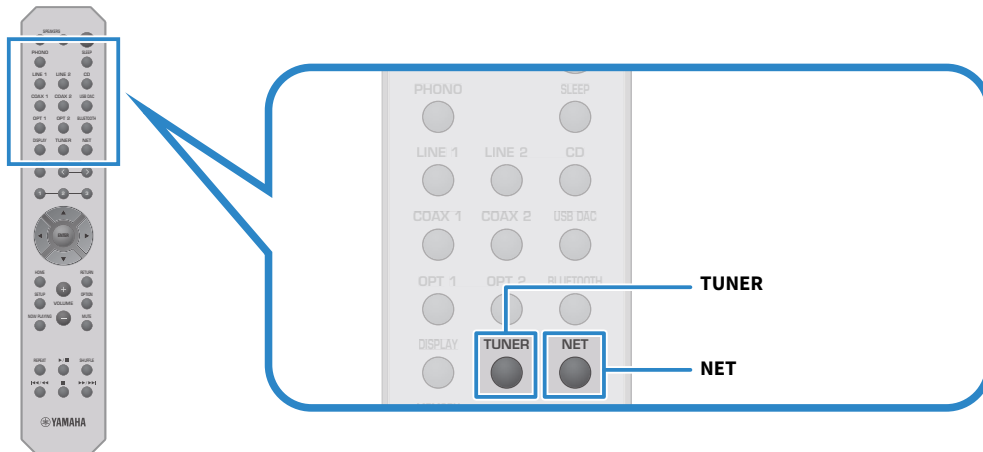

#### 2 Press the PRESET key and select the content you want to listen to.

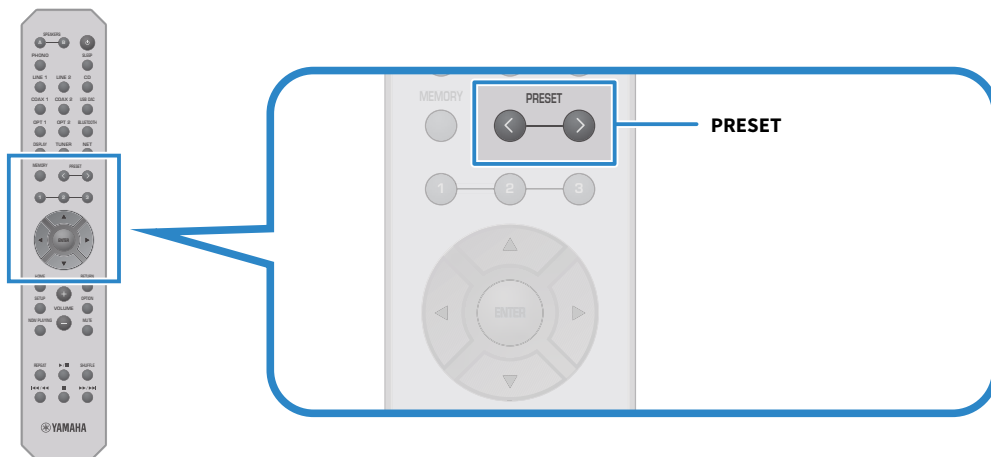

#### 3 Press the ENTER key.

The selected content starts playing.

### NOTE

- If no presets at all have been registered, “No Presets” is displayed on the front display.
- You can use MusicCast Controller to view a list of or delete registered content (song name or radio station name).
- “TUNER” presets can only be recalled when the input is on “TUNER”. Some presets, such as “Server”, “Net Radio” and/or streaming services, can only be recalled if the input is on “NET” (which can be selected by the NET key).
- Presets can only be recalled when the power is turned ON.

## ■ **Recalling a favorite (1/2/3 keys)**

If you press a numeric key (either 1/2/3), the selected content starts playing.

### **NOTE**

- When the power is in Standby and a number key is pressed, the power of this product turns ON and playback begins. To play content other than “TUNER” at this time, set “Network Standby” to “Auto” or “On” ahead of time, in “Network” in the Setup menu.
- The content can be recalled regardless of the selected input.

### **Related links**

“Configuring a network” (p.96)

## Sleep timer function

### Configuring the time for the sleep timer

Once the specified time elapses, the product goes into Standby.

**1 Press the SLEEP key repeatedly to set the desired time for the sleep timer.**

You can choose OFF, 120, 90, 60 or 30 minutes.

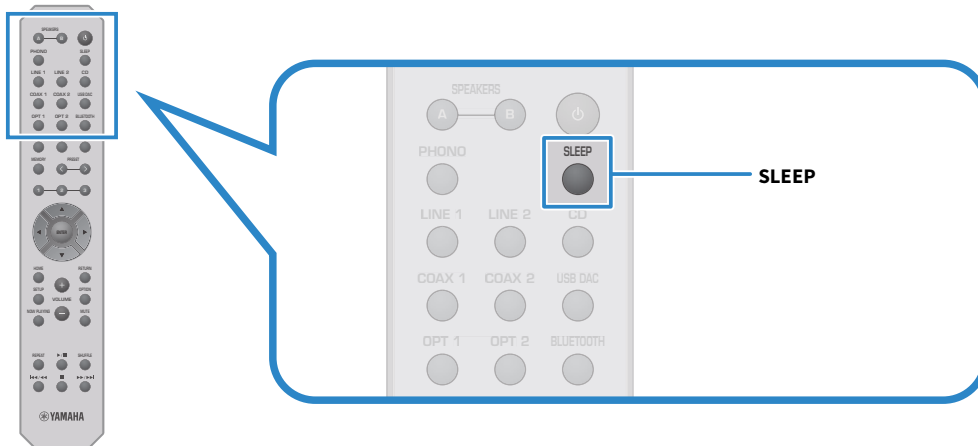

**NOTE**

The next time you set the timer, the time set the last time is called up first.

# SETTINGS

## Menus

### Menu structure

---

This product has the following menus, depending on the use.

**Setup menu:**

For detailed configuration of the functions of the product. Make settings with the remote control while looking at the front display.

**Advanced Setup menu:**

For configuring the product's system settings, etc. Can only be operated from the front panel.

**NOTE**

Play-related settings and information can be managed from the Option menu.

**Related links**

- [“List of Option menu” \(p.79\)](#)
- [“List of Setup menu items” \(p.95\)](#)
- [“List of Advanced Setup menu items” \(p.108\)](#)

## Setup menu (changing function settings)

### Basic operation of the Setup menu

---

For detailed configuration of the functions of the product. The basic operating methods of the Setup menu are as follows.

**1 Press the SETUP key.**



**2 Select a settings item with the cursor keys and press the ENTER key.**

To go back a level of the menu, press the RETURN key.

**3 Select the desired setting with the cursor keys (◀/▶).**

**4 Press the SETUP key.**

This completes the configuration.

#### Related links

- “Menu structure” (p.93)
- “List of Setup menu items” (p.95)

## List of Setup menu items

Items in the Setup menu are as follows.

Item	Page	
<b>Network</b>	<b>Connection</b>	96
	<b>Network Info</b>	
	<b>IP Address</b>	
	<b>DMC Control</b>	
	<b>Network Standby</b>	
	<b>Network Name</b>	
	<b>Network Update</b>	
<b>MCLink Pow Intlck</b>		
<b>Bluetooth</b>	<b>Bluetooth</b>	101
	<b>Bluetooth Standby</b>	
<b>YPAO</b>	<b>Speaker A</b>	102
	<b>Speaker B</b>	
	<b>Speaker A+B</b>	
	<b>Speaker Off</b>	
<b>Volume</b>	<b>Max Volume</b>	103
	<b>Initial Volume</b>	
<b>Auto Power Stdby</b>	104	
<b>ECO Mode</b>	105	
<b>Display</b>	<b>Brightness</b>	106
	<b>Display Sleep Time</b>	

## Configuring a network

---

### ■ Setting the method of connecting (wired/wireless) to a network

This sets the method of connecting this product to a network.

#### Setup menu

“Network” > “Connection”

#### Setting value

Wired	Connects via a network cable.
Wireless (Wi-Fi)	Connects via Wi-Fi.

#### Related links

- “To make a network connection” (p.37)
- “Selecting the wireless method of connecting to the network” (p.134)
- “Basic operation of the Setup menu” (p.94)

### ■ Checking network information

Displays networking information of this product.

#### Setup menu

“Network” > “Network Info”

New Firmware	Firmware update available or not
Status	State of network jack connections
MusicCastNetwork	State of MusicCast Network preparations
MAC Address	MAC address of this product (The MAC address is different depending on whether the connection to the network is wired or wireless)
SSID	Access point this product is connected to (only displayed for Wi-Fi connections)
IP Address	IP address of this product
Subnet Mask	Subnet mask
Default Gateway	IP address of the default gateway
DNS Server (P)	IP address of primary DNS server
DNS Server (S)	IP address of secondary DNS server

#### Related links

“Basic operation of the Setup menu” (p.94)



## ■ Auto-configuration of network information (DHCP function)

This function automatically configures the network information (IP address, subnet mask, default gateway, etc.) of this product using a DHCP server.

### Setup menu

“Network” > “IP Address” > “DHCP”

### Setting value

Off	DHCP server not used. Configures the network information manually.
On	DHCP server used. Configures the network information automatically.

### Related links

“Basic operation of the Setup menu” (p.94)

## ■ Configuring network information manually

This explains how to configure the network information (IP address, subnet mask, default gateway, etc.) of this product manually.

### Setup menu

“Network” > “IP Address”

- 1 Select “Off” for “DHCP”.**
- 2 Select item you want to set with the cursor keys (▲/▼).**
- 3 Use the cursor keys (◀/▶) to move the cursor position and the cursor keys (▲/▼) to set the network information.**
- 4 Press the ENTER key.**
- 5 To set a different item, repeat steps 2 to 4.**
- 6 Press the SETUP key.**

This completes the configuration.

### Related links

“Basic operation of the Setup menu” (p.94)

SETTINGS > Setup menu (changing function settings)

## ■ Configuring operations from a digital media controller

This configures whether this product can be controlled from a digital media controller (DMC). When enabled, playback of this product can be controlled from a DMC on the same network as the product.

### Setup menu

“Network” > “DMC Control”

### Setting value

Disable	Disables control from a DMC.
Enable	Enables control from a DMC.

### Related links

“Basic operation of the Setup menu” (p.94)

## ■ Configuring network standby

This sets whether the power of this product can be turned ON from a network device.

### Setup menu

“Network” > “Network Standby”

### Setting value

Off	Disables network standby.
On	Enables network standby. This consumes more energy than when it is “Off”.
Auto	Enables network standby. The product goes into a power-save mode to save energy when in network standby and “Bluetooth Standby” is “Off” and the network is disconnected for a certain period of time.

### NOTE

- If “Network Standby” is set to “Off”, “Bluetooth Standby” setting is disabled.
- When in the power save mode, this product cannot be turned ON from a network device, even if it is connected via a network cable. Turn the power of this product ON manually.

### Related links

- “Configuring Bluetooth” (p.101)
- “Basic operation of the Setup menu” (p.94)

## ■ Setting the network name of this product

You can change the network name of this product that is displayed on the network.

## Setup menu

“Network” > “Network Name”

- 1 Press the ENTER key.**
- 2 Use the cursor keys (◀/▶) to move the cursor position and the cursor keys (▲/▼) to edit the name.**

Press the MEMORY key to delete the character to the left of the cursor. Press the PRESET key to insert a new character one character before the character to the left of the cursor.

- 3 Press the ENTER key.**

- 4 Press the SETUP key.**

This completes the configuration.

## Related links

“Basic operation of the Setup menu” (p.94)

## ■ Updating the firmware

Firmware is updated to add functionality to this product and/or resolve problems.

The latest firmware is available via the network. For details, see the Yamaha website.

## Setup menu

“Network” > “Network Update”

## Options

Perform Update	Update firmware via the network. This item is only displayed when new firmware is available.
Firmware Version	Displays the version of the firmware.
System ID	Displays the unique System ID of this product.

## NOTE

- When there is an update notification for the latest firmware, press the ENTER key to update the firmware.
- Do not execute this other than when updating the firmware. Before executing an update, check the information provided with the firmware.

## Related links

- “Updating the firmware” (p.116)
- “Basic operation of the Setup menu” (p.94)

SETTINGS > Setup menu (changing function settings)

## ■ **Configuring power interlock with MusicCast-compatible devices and this product**

This function allows you to set whether MusicCast-compatible devices (slave) turn ON in tandem with this product (master) when it is turned ON.

### **Setup menu**

“Network” > “MCLink Pow Intlck”

### **Setting value**

Off	Does not link the power of this product and that of MusicCast-compatible devices.
On	Links the power of this product and that of MusicCast-compatible devices.

### **Related links**

“Basic operation of the Setup menu” (p.94)

## Configuring Bluetooth

---

### ■ Configuring to use Bluetooth

This sets whether or not to use the Bluetooth function.

#### Setup menu

“Bluetooth” > “Bluetooth”

#### Setting value

Off	Disables Bluetooth functions.
On	Enables Bluetooth functions.

#### Related links

- “Playing via a Bluetooth® connection” (p.69)
- “Basic operation of the Setup menu” (p.94)

### ■ Configuring Bluetooth Standby

This sets whether the power of this product can be turned ON from a Bluetooth device. When set to “On”, this product is turned ON automatically when a connection is made with a Bluetooth device.

#### Setup menu

“Bluetooth” > “Bluetooth Standby”

#### Setting value

Off	Disables the Bluetooth Standby function.
On	Enables the Bluetooth Standby function. This consumes more energy than when set to “Off”.

#### NOTE

This setting is not available when “Network Standby” in the Setup menu is set to “Off”.

#### Related links

- “Configuring a network” (p.96)
- “Basic operation of the Setup menu” (p.94)

## Configuring YPAO

---

### ■ Reflecting YPAO measurements in speaker settings

Sets whether to reflect YPAO measurements in speaker settings.

“---” is displayed if YPAO has not been run yet, so this setting is not available.

#### Setup menu

“YPAO” > (each speaker) > “Setting”

#### Setting value

Off	Disables reflection of YPAO measurement results.
On	Enables reflection of YPAO measurement results.

#### NOTE

- When YPAO is run, “YPAO” is automatically turned “On”.
- Even if it is turned “Off” (disabled), the settings are retained.

#### Related links

- “Running YPAO” (p.44)
- “Basic operation of the Setup menu” (p.94)

### ■ Automatically adjust bass/treble balance in tandem with volume

Sets whether to use the YPAO Volume function, which is linked to the volume and automatically adjusts the bass/treble balance based on the YPAO measurements.

When this is “On”, it allows you to enjoy a natural balance in sound quality, even at low volumes.

#### Setup menu

“YPAO” > (each speaker) > “YPAO Volume”

#### Setting value

Off	Disables YPAO Volume.
On	Enables YPAO Volume.

#### NOTE

- When “YPAO” is “On”, the YPAO Volume function can be set.
- When YPAO is run, “YPAO Volume” is automatically turned “On”.
- When listening at a low volume, such as at night, we recommend setting “YPAO Volume” to “On”.

#### Related links

- “Running YPAO” (p.44)
- “Basic operation of the Setup menu” (p.94)

## Configuring the volume

---

### ■ Setting the maximum volume

This sets the maximum volume that can be set via the VOLUME keys of the remote control, etc.

#### Setup menu

“Volume” > “Max Volume”

#### Setting value

-50 dB to 0 dB

#### Related links

“Basic operation of the Setup menu” (p.94)

### ■ Setting the power-ON volume

This sets the volume for when the power is turned ON.

#### Setup menu

“Volume” > “Initial Volume”

#### Setting value

Off	Uses the volume from the last time the power went into Standby.
Mute	Mutes the volume.
-96.5 dB to 0 dB	Uses the specified volume. Enabled only when the volume is set lower than “Max Volume”.

#### Related links

“Basic operation of the Setup menu” (p.94)

## Configuring auto power standby

---

This setting is for making the power of this product go into Standby automatically.

### Setup menu

“Auto Power Stdby”

### Setting value

Off	Does not go into Standby automatically.
On	Goes into Standby when any of the following conditions is met. <ul style="list-style-type: none"><li>• When the product has not been operated for 8 hours</li><li>• When the input is “NET” (which can be selected by the NET key) or “Bluetooth” and it has not been played for 20 minutes</li></ul>

### Related links

“Basic operation of the Setup menu” (p.94)



## Setting the product to ECO mode

---

Sets the product to the ECO mode (power-saving function).

When the setting has been changed, press the ENTER key to restart the product. The new setting is applied after restarting.

### Setup menu

“ECO Mode”

### Setting value

Off	Disables the ECO mode.
On	Enables the ECO mode. The front display may become dark.

### Related links

“Basic operation of the Setup menu” (p.94)

## Configuring the front display

---

### ■ Setting the brightness of the front display

For adjusting the brightness of the front display. The bigger the value, the brighter the display.

#### Setup menu

“Display” > “Brightness”

#### Setting value

-3 to 3

#### NOTE

The brightness of the display is dimmed (equivalent to the setting “-3”) to protect the display unit when the product is not operated for a certain amount of time. The display returns to its normal brightness when the remote control or front panel is operated.

#### Related links

“Basic operation of the Setup menu” (p.94)

### ■ Configuring the front display to turn OFF automatically

This function sets the time until the front display turns OFF automatically.

#### Setup menu

“Display” > “Display Sleep Time”

#### Setting value

Off	Does not turn OFF automatically.
15 minutes	Turns OFF automatically when the product has not been operated for 15 minutes.
30 minutes	Turns OFF automatically when the product has not been operated for 30 minutes.

#### NOTE

After turning OFF, the display comes back ON when the remote control or front panel are operated.

#### Related links

“Basic operation of the Setup menu” (p.94)

## Advanced Setup menu (changing system settings)

### Basic operation of the Advanced Setup menu

---



For changing system settings for the product. Operate as follows from the front panel.

- 1 If the power of the product is ON, press the  (Power) Switch to turn it OFF.**
- 2 Press the  (Power) Switch while holding down RETURN.**

The following screen is shown on the front display.



- 3 Turn SELECT to select a setting item.**
- 4 Press SELECT to set the setting item.**

To go back a level of the menu, press the RETURN key.
- 5 Turn SELECT to select the setting value.**
- 6 Press SELECT to set the setting value.**
- 7 Press the  (Power) Switch to turn OFF the power.**
- 8 Press the  (Power) Switch again to turn the power back ON.**

The changes to settings are reflected.

#### Related links

- “Menu structure” (p.93)
- “List of Advanced Setup menu items” (p.108)

## List of Advanced Setup menu items

---

Items in the Advanced Setup menu are as follows.

<b>Item</b>	<b>Page</b>
<b>Language</b>	109
<b>Remote ID</b>	110
<b>Frequency Step</b>	111
<b>Initialization</b>	112
<b>Sp Impedance</b>	113
<b>Control Knob</b>	114

## Configuring the menu language

---

This sets the language for menus, such as the Setup menu.

### Advanced Setup menu

“Language”

#### Setting value

English	English
日本語	Japanese
Français	French
Deutsch	German
Español	Spanish
Русский	Russian
Italiano	Italian

#### Related links

“Basic operation of the Advanced Setup menu” (p.107)

## Configuring the Remote ID

---

This changes the Remote ID of the main unit of this product. Normally you should set it to “ID1”.

### Advanced Setup menu

“Remote ID”

### Options

---

ID1	Sets the Remote ID to ID1.
Auto	Assigns the Remote ID automatically. Use this setting when operating the product using the remote control that is included with some Yamaha CD/network players.

---

### NOTE

If the ID of the main unit and the remote control do not match, the message “Remote ID Mismatch” appears on the front display when you try to use the remote control.

### Related links

“Basic operation of the Advanced Setup menu” (p.107)

## Changing the FM/AM tuning frequency setting

---

### Model For

Asia, Taiwan, Central and South America

Sets the FM/AM tuning frequency setting of this product depending on your country or region.

### Advanced Setup menu

“Frequency Step”

### Setting value

---

FM100/AM10	Adjusts the FM frequency by 100-kHz steps and AM by 10-kHz steps.
FM50/AM9	Adjusts the FM frequency by 50-kHz steps and AM by 9-kHz steps.

---

### NOTE

Preset (registered radio stations) and frequency will be initialized if you change the radio tuning frequency steps.

### Related links

- “Preparing to listen to the radio” (p.60)
- “Basic operation of the Advanced Setup menu” (p.107)

## Initializing settings

---

Initializes (resets) the various settings of the product.

### Advanced Setup menu

“Initialization”

### Options

All	Initializes all settings. However, “Control Knob” setting is not initialized.
Network	Initializes network-related settings.
Cancel	Cancels initialization.

### Related links

- “Basic operation of the Advanced Setup menu” (p.107)
- “Correcting the knobs” (p.114)
- “Default values” (p.148)



SETTINGS > Advanced Setup menu (changing system settings)

## Switching speaker impedance

---

Changes this product setting to match the impedance of the connected speakers.

### Advanced Setup menu

“Sp Impedance”

### Setting value

4Ω MIN	For speakers with an impedance of 4-ohm or more but less than 8-ohm.
8Ω MIN	For speakers with an impedance of 8-ohm.

### Related links

“Basic operation of the Advanced Setup menu” (p.107)

## Correcting the knobs

---

You can correct the deviation of the control knobs on the front panel, such as BASS, TREBLE and BALANCE from the center positions, and LOUDNESS from the FLAT position. You may perform this calibration, for example, when the error message “E-21:Control Knob” is displayed during the YPAO measurements.

### Advanced Setup menu

“Control Knob”

#### 1 Press SELECT.

“Start Calibration” is shown on the front display.

#### 2 Adjust the control knob positions correctly.

Make sure BASS, TREBLE and BALANCE are in the center positions, and LOUDNESS is in the FLAT position.

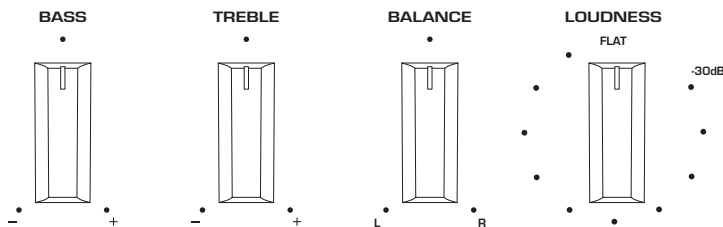

#### 3 Press SELECT.

Calibration is performed automatically, and once the process is complete, “Completed” is displayed on the front display.

This completes the configuration.

### ■ In case of error

If “Err: Not Center” and “Error: \*\*\*” are displayed on the front display after the calibration, the related knob shown as “\*\*\*” is out of position. Press RETURN, and repeat the process from step 2 again.

### Related links

- “Basic operation of the Advanced Setup menu” (p.107)
- “Initializing settings” (p.112)
- “Running YPAO” (p.44)

# UPDATING

## Checking the version of firmware

### Checking the version of firmware

---

The version of this product's firmware can be checked from the Setup menu. Do so as follows.

- 1 Press the SETUP key.**
- 2 Select "Network" with the cursor keys (▲/▼) and then press the ENTER key.**
- 3 Then select "Network Update" and press the ENTER key.**
- 4 Check "Firmware Version".**

The version of firmware appears on the front display.

To close the Setup menu, press the SETUP key.

#### NOTE

The version of firmware can also be checked from the MusicCast Controller menu.

#### Related links

- "Configuring a network" (p.96)
- "Updating the firmware" (p.116)

## Updating the firmware

### Updating the firmware

---

Updated firmware is provided to add functionality to this product and/or resolve problems. For details about firmware, please visit the Yamaha website. Firmware can be updated via the Internet.

#### **Related links**

[“Updating the firmware via your network” \(p.117\)](#)

## Updating the firmware via your network

---

If this product is connected to the Internet and it is ready for a new firmware update, the following message appears when you turn this product ON.

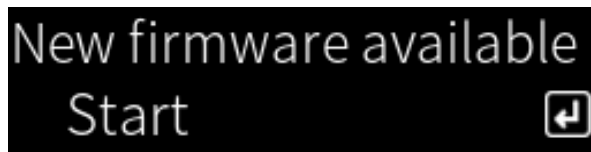

Update the firmware over the network from this screen.

### NOTICE

- Do not operate the product or unplug its power cord or network cable during the updating process. If the process is interrupted, this product may become unusable. If that happens, please contact an authorized Yamaha service center to have it repaired.

### 1 Press the ENTER key.

“Perform Update” is displayed on the next screen.

### 2 Press the ENTER key.

The screen turns off and the firmware update begins.

### 3 Once “Update Success” and “Please ... Power OFF!” are shown on the front display, press the unit’s (Power) Switch.

This completes the firmware update.

### NOTE

- It takes about 20 minutes to update the firmware.
- You can check whether there are any new firmware updates by selecting the following menu items in order: Setup menu > “Network” > “Network Info” > “New Firmware”.
- If new firmware is available, you can update it via “Network Update” in the “Network” on the Setup menu.

### Related links

- “Configuring a network” (p.96)
- “Updating the firmware” (p.116)

# TROUBLESHOOTING

## If you think there is a problem

### If you think there is a problem, the 1st step is checking the following

---

If the product stops working normally while you are using it, check the following items first.

- The power plugs of the product and audio device(s) (CD player, etc.) are firmly plugged into their outlets.
- The power of the product, the subwoofer and audio devices (CD player, etc.) is turned on.
- The cables between devices are securely plugged into the jacks.

## Problems with power, system, and/or remote control

---

### Power fails to turn ON

● **The protective circuit has been activated 3 times in a row.**

If the Power Indicator on the front panel flashes when you try to turn the power ON, it fails to come on in order to protect the product. Please contact an authorized Yamaha service center to have it repaired.

### Power fails to turn OFF

● **The built-in microcomputer has frozen due to an external electrical shock (such as from lightning or excessive static electricity) or a drop in electrical voltage.**

Turn OFF the power using the ⏻ (Power) Switch on the front panel, wait at least 15 seconds, then turn the power ON.

### Power turns OFF right away

● **You may be trying to turn ON the power while the speaker cables are shorted.**

Firmly twist the core wires of each of the speaker cables and then reconnect them to this product and the speakers. For more details, refer to the following.

- “Connecting speakers” (p.28)

### Power switches to standby automatically

● **The sleep timer activated.**

Turn the power back ON and start playback. For more details, refer to the following.

- “Configuring the time for the sleep timer” (p.92)

● **The Auto Power Standby function was activated as the set period of time elapsed without operating the product.**

To disable the Auto Power Standby function, set “Auto Power Stdby” to “Off” from the Setup menu. For more details, refer to the following.

- “Configuring auto power standby” (p.104)

● **Due to a short in the speaker cables, the protective circuit was activated.**

Firmly twist the core wires of each of the speaker cables and then reconnect them to this product and the speakers. For more details, refer to the following.

- “Connecting speakers” (p.28)

● **The volume was increased too high, activating the protective circuit.**

Lower the volume.

### The product does not respond to controls

● **The built-in microcomputer has frozen due to an external electrical shock (such as from lightning or excessive static electricity) or a drop in electrical voltage.**

Turn OFF the power using the ⏻ (Power) Switch on the front panel, wait at least 15 seconds, then turn the power ON.

TROUBLESHOOTING > If you think there is a problem

### **This product cannot be operated with the remote control**

● **The ⏻ (Power) Switch on the front panel is OFF.**

Turn the ⏻ (Power) Switch on the front panel ON.

● **It is outside the operating range.**

Try using it within the operating range. For more details, refer to the following.

- “How to insert batteries, and its operating range” (p.24)

● **Its batteries are dead.**

Replace with new batteries.

● **Strong light or sunlight is hitting the remote control signal receiver on the main unit.**

Change the lighting or the orientation of the unit.

● **The IDs of the main unit and the remote control do not match.**

Change the ID of the main unit or of the remote control. For more details, refer to the following.

- “Configuring the Remote ID” (p.110)

### **The front display is OFF**

● **Pure Direct is ON.**

When using Pure Direct, the front display turns OFF. After turning OFF, the display comes back ON when the remote control or front panel is operated.

● **The front display is set to turn OFF automatically.**

Set “Display Sleep Time” to “Off” from the Setup menu. For more details, refer to the following.

- “Configuring the front display” (p.106)



## Problems with the audio

---

### No sound

● **A different input is selected.**

Use the input source selection key to select the correct input. For more details, refer to the following.

- “Selecting an input source” (p.53)

● **The product is receiving an input signal that it cannot play.**

This product cannot play some digital audio formats. Make sure the signal is in a format that this product can play. See the following for information on supported file formats and decoding formats.

- “Supported file formats on this product (network)” (p.139)
- “Specifications” (p.142)

● **A cable connecting this product and an audio device is damaged.**

If you check the connections and they seem fine, replace the cable with a different one.

● **The output speakers are not set correctly.**

Press the SPEAKERS A key and/or SPEAKERS B key corresponding to the jacks to which the speakers are connected to turn their output ON. For more details, refer to the following.

- “Selecting the output speakers” (p.52)

If using an external amp, check its connections and power.

● **The audio is muted.**

Press the MUTE key to cancel muting.

● **Headphones are plugged into the PHONES jack.**

Unplug the headphones.

● **This product was put into Standby by the Auto Power Standby function.**

Set “Auto Power Stdbby” to “Off” from the Setup menu. For more details, refer to the following.

- “Configuring auto power standby” (p.104)

### Volume cannot be increased

● **The maximum volume is set too low.**

Adjust the maximum with “Max Volume” on the Setup menu. For more details, refer to the following.

- “Configuring the volume” (p.103)

● **The power of the external device connected to the output jacks of this product is OFF.**

Turn all corresponding devices ON.

● **The volume interlocks between each device and this product have not been configured for Bluetooth/AirPlay playback from a Bluetooth device or AirPlay device.**

Configure the volume interlocks of each device via “Volume Interlock” on the Option menu. For more details, refer to the following.

- “Setting volume interlock with this product when playing an AirPlay/Bluetooth device” (p.85)

● **LOUDNESS is set too low.**

First, lower the volume with VOLUME, then return LOUDNESS to the FLAT position and readjust the volume.

TROUBLESHOOTING > If you think there is a problem

### **No sound is output from a particular speaker**

- **BALANCE is set to the maximum for either left or right.**

Adjust BALANCE so sound comes out of the left and right speakers.

- **A cable connecting this product and the corresponding speaker is damaged.**

Check the connections of each jack on the speaker(s) and this product, and if no problem exists with the connections, the cable may be broken. Replace the cable with a different one.

- **The corresponding speaker may be damaged.**

You can check this by replacing it with a different speaker that is functioning normally. If sound does not come from the replacement speaker either, this product may be faulty.

### **No sound is output from the subwoofer**

- **Output to the subwoofer is disabled.**

Run the YPAO function. For more details, refer to the following.

- “Running YPAO” (p.44)

Check the setting of subwoofer. For more details, refer to the following.

- “Using the app to check YPAO measurements and change settings” (p.50)

- **The volume of the subwoofer is extremely low.**

Adjust the volume on the subwoofer itself.

- **The auto standby function of the subwoofer (automatically turning the power OFF) was activated.**

Disable auto-standby or adjust its operating sensitivity on the subwoofer itself.

### **Noise is being output**

- **Digital and/or high frequency equipment is located near this product.**

Increase the distance between this product and such devices.

- **A cable connecting this product and an audio device is damaged.**

If you check the connections and they seem fine, replace the cable with a different one.

### **Sound is distorted**

- **The power of an external amplifier, etc. connected to the PRE OUT jacks of this product is OFF.**

Turn all corresponding devices ON.

- **The volume is too loud.**

Lower the volume.

### **The subwoofer volume feels too strong during Pure Direct playback**

- **The subwoofer volume and crossover frequency are not adjusted.**

After adjust the subwoofer's settings of the volume and crossover frequency to your favorite value during Pure Direct playback, run the YPAO function. For more details, refer to the following.

- “Running YPAO” (p.44)

## Problems with FM radio

---

### Radio reception is poor or has noise

● **It is receiving multipath (multiple reflections) or other interference.**

Change the height, orientation, and/or location of the FM antenna.

● **The radio station is being received from a distant region.**

Switch to monoaural reception via “FM Mode” on the Option menu. For more details, refer to the following.

- “Setting the reception mode (stereo/mono) for FM radio” (p.82)

### Automatic selection of FM radio stations is not possible

● **The FM radio stations are being received from distant regions.**

Manually select stations. For more details, refer to the following.

- “Selecting a radio station” (p.63)

Alternatively, use an outdoor antenna (commercially-available) .

### Cannot select radio stations by pressing the PRESET key

● **No radio stations are registered.**

If no radio stations at all have been registered, “No Presets” is displayed on the front display when the PRESET key is pressed. Register radio stations to preset numbers. For more details, refer to the following.

- “Registering radio stations manually” (p.67)

Auto presets can also be used for FM radio stations. For more details, refer to the following.

- “Auto-registering FM radio stations (auto preset)” (p.66)

If the signals of FM radio stations are weak, no stations at all may be registered when auto preset is performed. In that case, register them manually.

● **The input is on something other than “TUNER”.**

Press the TUNER key. “TUNER” presets can only be recalled when the input is on “TUNER”.

## Problems with AM radio

---

### AM radio reception is poor or has noise

● **It is picking up noise from sources like fluorescent lights, motors, etc.**

It is difficult to completely eliminate noise from the environment. However, using a commercially-available outdoor antenna may help reduce the noise.

### Automatic selection of AM radio stations is not possible

● **The AM radio signal is weak.**

Change the direction of the AM antenna.

Manually select stations. For more details, refer to the following.

- “Selecting a radio station” (p.63)

### Cannot register (preset) any AM radio stations

● **The auto registration function (auto preset) is being used.**

Auto preset only works with FM radio stations. Please register AM radio stations manually. For more details, refer to the following.

- “Registering radio stations manually” (p.67)

### Cannot select radio stations by pressing the PRESET key

● **No radio stations are registered.**

If no radio stations at all have been registered, “No Presets” is displayed on the front display when the PRESET key is pressed. Register radio stations to preset numbers. For more details, refer to the following.

- “Registering radio stations manually” (p.67)

● **The input is on something other than “TUNER”.**

Press the TUNER key. “TUNER” presets can only be recalled when the input is on “TUNER”.

## Problems with DAB radio

---

### No DAB radio reception

- **An initial scan has not been performed.**

Perform an initial scan to receive DAB radio. For details, see the following:

- “Preparing the DAB tuning” (p.61)

### No DAB radio reception even after performing an initial scan

- **Reception strength of DAB radio is poor.**

Check reception strength via “Tune AID” on the Option menu, and adjust the antenna height or orientation, or place it in a different location. For details, see the following:

- “Preparing the DAB tuning” (p.61)

- **There is no DAB coverage in your area.**

Check with your dealer or WorldDMB online at “<http://www.worlddab.org>” for a listing of the DAB coverage in your area.

### DAB radio reception is poor or has noise

- **There is multi-path interference.**

Check reception strength via “Tune AID” on the Option menu, and adjust the antenna height or orientation, or place it in a different location. For details, see the following:

- “Preparing the DAB tuning” (p.61)

- **Your area is too far from the DAB station transmitter.**

Use an outdoor antenna. We recommend using a sensitive multi-element antenna.

### DAB information is not available or is inaccurate

- **The selected DAB radio station may be temporarily out of service or may not provide information.**

Contact the DAB broadcaster.

### No DAB radio sound

- **The selected DAB radio station may be temporarily out of service.**

Try the station later or select another station.

## Problems with USB DAC

---

### This product is not recognized by the PC

- **The product is connected to a PC that is running an OS that is not guaranteed to work with it.**  
Connect the product to a PC that is running an OS that is guaranteed to work with it.
- **The USB cable is not connected correctly.**  
Plug the USB cable back in correctly.
- **The dedicated “Yamaha Steinberg USB Driver” is not installed (Windows only).**  
Install “Yamaha Steinberg USB Driver”. For more details, refer to the following.
  - “Connecting to your computer (USB DAC function)” (p.26)

### USB DAC stops working normally

- **This product is connected to your PC via a USB hub.**  
Connect the product to your PC directly without using a USB hub.
- **USB DAC does not work normally due to USB version compatibility or other effects.**  
Connect the USB cable to another port of your PC and check whether USB DAC is back to normal. Furthermore, try connecting to a USB 2.0 port.

### There is noise or interruption when playing music files on the PC

- **Another application on the PC was started while it was playing a music file.**  
The audio may be interrupted or have noise when you start another application on your PC while playing a music file. Do not start other applications while playing a music file.
- **Setting for the buffer size of the dedicated “Yamaha Steinberg USB Driver” is incorrect (Windows with ASIO compatible software only).**  
Try the following steps to change “Yamaha Steinberg USB Driver” setting, and check whether the sound improves.
  - 1 Open the Control Panel of “Yamaha Steinberg USB Driver”.  
Startmenu→Yamaha Steinberg USB Driver→Control Panel
  - 2 Select “ASIO” tab and increase the value for “Buffer Size”.
  - 3 Restart the music software on your PC.

### Cannot play music files that are on the computer (no sound is output from this product)

- **The audio output of the PC and/or application is set to mute.**  
Cancel the mute setting on the PC and/or in the application.
- **The dedicated “Yamaha Steinberg USB Driver” settings were changed.**  
Restart the music software on your PC.
- **The USB connection was cut off while playing a music file.**  
Turn this product OFF and then turn it ON. After that, restart the music software on your PC and play music files.

TROUBLESHOOTING > If you think there is a problem

● **While the PC was running music software and the power of this product was ON, you connected your PC to this product, and you switched the product's input to "USB DAC".**

Close the music software and then, try the following steps:

- ① After turning this product OFF, connect your PC to the product.
- ② Turn the product ON.
- ③ Switch the product's input source to "USB DAC".
- ④ Start the music software on your PC and play music files.

● **The audio output device of your computer and/or application are not configured correctly.**

Check the settings of the audio output device of your computer and/or application. For more details, refer to the following.

- "Playing music that is on your computer" (p.77)

● **An audio signal is being input that this product does not recognize.**

Input an audio signal in a format and sampling rate that this product can play. For more details, refer to the following.

- "Playable formats using USB DAC" (p.140)

## Problems with network

---

### Network functions cannot be used

- **Network information (IP address) was not acquired properly.**

Enable the DHCP server function of the router. Set “DHCP” to “On” from the Setup menu of this product. For more details, refer to the following.

- “Configuring a network” (p.96)

If you configure the network information manually instead of using the DHCP server, make sure the IP address of this product is not the same as any other network devices.

- **It is connected to an IPv6 type of router.**

Some network functions of this product are not supported in IPv6 networks. Connect to an IPv4 network.

### Cannot connect to the Internet via a wireless LAN router (access point)

- **The power of the wireless LAN router is OFF.**

Turn the wireless LAN router ON.

- **This product is too far from the wireless LAN router.**

Move the wireless LAN router and/or this product closer to each other.

- **There is an obstacle between this product and the wireless LAN router.**

Remove the obstacle between this product and the wireless LAN router.

- **The wireless LAN router (access point) is configured to use Channel 14.**

Change the wireless LAN router (access point) settings so it uses one of the channels between 1 and 13.

- **The MAC address filter of the wireless LAN router (access point) is enabled.**

Set the MAC address filter of the wireless LAN router (access point) to disabled.

### Cannot find the wireless network

- **Electromagnetic waves from a microwave oven or other wireless devices are interfering with wireless communication.**

Turn those devices OFF, or move them away from this product and the wireless LAN router. Also, if your wireless LAN router supports the 5 GHz frequency band, switch the connection to the 5 GHz band.

- **Access to the network is restricted by the firewall settings of the wireless LAN router.**

Check the firewall settings of your wireless LAN router.

### Cannot detect a media server (PC/NAS)

- **The share settings of the media server are not correct.**

Change the share settings of the media server so this product can access the folders on the media server.

- **Access to the media server is restricted by security software settings, etc.**

Check the security software settings of the media server and/or router.

- **This product is not connected to the same network as the media server.**

Check the network connections and/or the router settings, and connect this product with the media server over the same network (router).



### **Media server (PC/NAS) files will not display (or play)**

● **This product or the media server are using unsupported file format(s).**

Use file formats that are supported by both this product and the media server. Refer to the following for the music file formats supported by this product.

- “Supported file formats on this product (network)” (p.139)

### **Media server (PC/NAS) content cannot be played when its preset number is selected**

● **The power is OFF.**

Make sure the power of the media server (PC/NAS) is ON.

● **Not connected to the network.**

Check the network connections and/or the router settings.

● **The registered content (files) was moved to a different folder.**

Register the content again.

● **Other music files were added to or deleted from the folder.**

It may not be possible to recall registered content. Register the content again.

### **Cannot play Internet radio**

● **Not connected to the Internet.**

In order to use Internet radio, this product must be connected to the Internet. Check and make sure the network information (IP address) was acquired properly. For more details, refer to the following.

- “Configuring a network” (p.96)

● **The selected Internet radio station service is not currently available.**

It may not be possible to receive the radio station due to a network error on the radio station side, or the service may currently be stopped. Wait for a while and try playing it again, or select a different radio station.

● **The selected Internet radio station is broadcasting silence.**

Some radio stations broadcast silence at some times. In such a case, no sound plays even if the station is being received. Wait for a while and try playing it again, or select a different radio station.

● **Access to the network is restricted by the firewall settings of the router or network devices.**

Check the firewall settings. Note that Internet radio can only be played via the port specified by each radio station. The port number differs depending on the radio station.

### **When using AirPlay, this product is not detected by the iPhone**

● **You are using a router that supports multi SSID.**

The network isolating function of your wireless LAN router (access point) may be preventing access to this product. When connecting your iPhone, use an SSID that allows access to this product (try connecting to the primary SSID).

### **Music doesn't play via AirPlay**

● **You are trying to listen to music that cannot be played on your iPhone.**

Make sure the files are playable. If you cannot play it even on your iPhone itself, the music data and/or storage area may be damaged.

TROUBLESHOOTING > If you think there is a problem

### **This product is not detected by the dedicated app on the mobile device**

- **This product is not connected to the same network as the mobile device.**

Check the network settings and/or the router settings and connect to the same network.

- **You are using a router that supports multi SSID.**

The network isolating function of your wireless LAN router (access point) may be preventing access to this product. When connecting your mobile device, use an SSID that allows access to this product (try connecting to the primary SSID).

### **Unable to update the firmware via the network**

- **Your network connection is poor.**

Wait a while and try again.

## Problems with Bluetooth

---

### Cannot connect with a Bluetooth device

● **The wireless antenna of this product is not up.**

Stand the wireless antenna upright.

● **The Bluetooth function of this product is disabled.**

Enable the Bluetooth function with “Bluetooth” on the Setup menu. For more details, refer to the following.

- “Configuring Bluetooth” (p.101)

● **The Bluetooth function of the Bluetooth device is OFF.**

Turn ON the Bluetooth function of the Bluetooth device.

● **This product is connected to a different Bluetooth device.**

Terminate the current Bluetooth connection and connect to the desired Bluetooth device. For more details, refer to the following.

- “Playing via a Bluetooth® connection” (p.69)

● **This product and the Bluetooth device are too far apart.**

Move this product and the Bluetooth device closer together.

● **Interference from device(s) (microwave oven, wireless LAN, etc.) using the 2.4 GHz frequency band is impeding wireless communications.**

Move this product and/or the Bluetooth device away from those devices. Also, if your wireless LAN router supports the 5 GHz frequency band, switch the connection to the 5 GHz band.

● **The Bluetooth device you are using does not support the A2DP and/or AVRCP profiles.**

Use a Bluetooth device that supports the A2DP and/or AVRCP profiles.

● **The connection information registered to the Bluetooth device is not functioning properly for some reason.**

Delete the connection information of the Bluetooth device and then reconnect this product to the Bluetooth device. For more details, refer to the following.

- “Playing via a Bluetooth® connection” (p.69)

### When connected via Bluetooth®, there is no sound, or the sound is intermittently disrupted

● **The volume of the Bluetooth device is too low.**

Turn up the volume of the Bluetooth device.

● **The output-switching of the Bluetooth device is not set to this product.**

Set the output-switching of the Bluetooth device to this product.

● **The Bluetooth connection was cut off.**

Reconnect the Bluetooth. For more details, refer to the following.

- “Playing via a Bluetooth® connection” (p.69)

● **They are too far apart.**

Move the Bluetooth device closer to this product.

## Errors shown on the front display

When an error is shown on the front display, check it in the following table.

Message	Contents	Solution
<b>Check speaker wires</b>	The speaker cable(s) are shorted.	Firmly twist the core wires of each of the speaker cables and then reconnect them to this product and the speakers. For more details, refer to the following. <ul style="list-style-type: none"> <li>• “Connecting speakers” (p.28)</li> </ul>
<b>Access denied</b>	The media server (PC/NAS) is denying access.	Change the share settings of the media server (PC/NAS) so this product can access the folders on the media server.
<b>Access error</b>	There is a problem with the network.	Check whether the router and/or modem are ON and whether this product is connected properly with the router (or hub). For more details, refer to the following. <ul style="list-style-type: none"> <li>• “Connecting a network cable (wired connection)” (p.38)</li> <li>• “Preparing the wireless antenna (wireless connection)” (p.39)</li> </ul>
<b>Unable to play</b>	Music files cannot be played.	Make sure the files are playable on this product. Refer to the following for the music file formats supported by this product. <ul style="list-style-type: none"> <li>• “Supported file formats on this product (network)” (p.139)</li> </ul> If the file(s) are supported by this product but still cannot be played, the network may be overloaded.
<b>Internal error</b>	An internal error has occurred with this product.	Please contact an authorized Yamaha service center to have it repaired.
<b>Remote ID Mismatch</b>	The ID of the remote control does not match.	If you are using a Yamaha CD player, set the “Remote ID” setting in the Advanced Setup menu to “Auto”. For more details, refer to the following. <ul style="list-style-type: none"> <li>• “Configuring the Remote ID” (p.110)</li> </ul>
<b>Version Error</b>	Error in updating the firmware.	Try updating the firmware again. For more details, refer to the following. <ul style="list-style-type: none"> <li>• “Configuring a network” (p.96)</li> <li>• “Updating the firmware via your network” (p.117)</li> </ul>
<b>Update Failed</b>	Error in updating the firmware.	Update the firmware again.

# APPENDIX

## Product care

### Taking care of this product

---

Check the following before cleaning the product.

- Do not use chemicals such as benzene, thinner, or rubbing alcohol on the product. To avoid scratching the surface, wipe it dry with a soft cloth.

## Making wireless network connections

### Selecting the wireless method of connecting to the network

---

Select the connection method suiting your network environment.

- 1 Press the SETUP key.**
- 2 Select “Network” with the cursor keys (▲/▼) and then press the ENTER key.**
- 3 Then select “Connection” and “Wireless (Wi-Fi)” in that order and press the ENTER key.**

Select the method of setting up a wireless connection from the following.

- “Using the WPS button to make a wireless connection” (p.135)
- “Making a wireless connection with your iPhone (WAC)” (p.136)
- “Making a wireless connection manually” (p.137)

#### NOTE

Network settings can also be made when registering this product to the MusicCast Network. We recommend this method when using MusicCast.

#### Related links

“Registering with the MusicCast network” (p.43)

## Using the WPS button to make a wireless connection

---

Pressing the WPS button on your wireless LAN router is a simple way to configure a wireless connection.

### Setup menu

“Network” > “Connection” > “Wireless (Wi-Fi)”

- 1 Select “WPS” with the cursor keys (▲/▼).**
- 2 Follow instructions on the front display to make the wireless connection.**

During the process, pressing the WPS button on your wireless LAN router is needed.

Once the connection is established, “Completed” is displayed and the Wireless LAN indicator on the front panel lights up.

If “Not connected.” is displayed, either repeat the process from step 1 or try a different connection method.

This completes the wireless connection process.

### NOTE

This product cannot connect to a wireless LAN router (access point) using the WEP encryption method. In such case, try a different connection method.

#### **What is WPS?**

WPS (Wi-Fi Protected Setup) is a standard developed by the Wi-Fi Alliance. WPS make it easy to set up a wireless network.

### Related links

“Selecting the wireless method of connecting to the network” (p.134)

## Making a wireless connection with your iPhone (WAC)

---

Apply the network settings of your iPhone (iOS device) to this product to set up a wireless connection. Before starting setup, check and make sure your iPhone is connected to the wireless LAN router (access point).

### Setup menu

“Network” > “Connection” > “Wireless (Wi-Fi)”

- 1 Select “Share Wi-Fi (iOS)” with the cursor keys (▲/▼).**
- 2 While the Wi-Fi indicator is flashing, enter the Wi-Fi Settings screen of your iOS device, and set this product to the AirPlay speaker.**
- 3 Select the wireless network (access point) which is shared with this product.**

After the sharing operation is complete, this product will connect automatically to the selected wireless network (access point).

And the Wireless LAN indicator on the front panel will light up.

This completes the wireless connection process.

### NOTE

- The following settings are initialized.
  - Network settings
  - Bluetooth settings
  - Content registered to presets (songs from a media server, Internet radio stations, etc.)
  - Account information of the various music services
  - Repeat/shuffle settings
- This product cannot connect to a wireless LAN router (access point) using the WEP encryption method. In such case, try a different connection method.
- A warning message is displayed if a network cable is connected to this product. Unplug the network cable before operating the product.
- If an AirPlay password has been set up, cancel it temporarily and connect using WAC.

### Related links

“Selecting the wireless method of connecting to the network” (p.134)



## Making a wireless connection manually

---

Enter the required information and set up a wireless connection. You will have to configure the SSID (network name), encryption method and security key manually.

### Setup menu

“Network” > “Connection” > “Wireless (Wi-Fi)”

- 1 Select “Manual Setting” with the cursor keys (▲/▼).**
- 2 Enter the necessary information as indicated on the front display to make the wireless connection.**

To enter text, use the cursor keys (◀/▶) to move the cursor, and then the cursor keys (▲/▼) to change the character. Press the MEMORY key to delete the character to the left of the cursor. Press the PRESET key to insert a new character one character before the character to the left of the cursor.

Once the connection is established, “Completed” is displayed and the Wireless LAN indicator on the front panel lights up.

If “Not connected.” is displayed, either repeat the process or try a different connection method.

This completes the wireless connection process.

### Related links

“Selecting the wireless method of connecting to the network” (p.134)

## Supported devices and formats

### Supported Bluetooth devices

---

Check the following for the Bluetooth devices that can connect to this product.

- Bluetooth devices that support A2DP and AVRCP profiles can be connected.
- Connection to all Bluetooth devices is not guaranteed.

## Supported file formats on this product (network)

Of all the audio formats that may be received over the network, the following file formats can be played on this product.

File	Sampling frequency (kHz)	No. of quantization bits (bit)	Bit rate (kbps)	No. of channels	Gapless Playback Support
<b>WAV*</b>	32/44.1/48/88.2/96/ 176.4/192/352.8/384	16/24/32	-	2	○
<b>MP3</b>	32/44.1/48	-	8 to 320	2	-
<b>WMA</b>	32/44.1/48	-	8 to 320	2	-
<b>MPEG-4 AAC</b>	32/44.1/48	-	8 to 320	2	-
<b>FLAC</b>	32/44.1/48/88.2/96/ 176.4/192/352.8/384	16/24	-	2	○
<b>ALAC</b>	32/44.1/48/88.2/96	16/24	-	2	○
<b>AIFF</b>	32/44.1/48/88.2/96/ 176.4/192/352.8/384	16/24/32	-	2	○
<b>DSD</b>	2.8 MHz (DSD64)/ 5.6 MHz (DSD128)/ 11.2 MHz (DSD256)	1	-	2	○

\* linear PCM format only. Files in 32-bit float cannot be played.

- The file formats that can be played vary with the server software installed on the media server (PC/NAS). For more details, refer to the user's manual of the server software.
- Files protected by DRM (Digital Rights Management) cannot be played.

## Playable formats using USB DAC

---

The following are the signal formats and sampling frequencies that can be played the USB DAC function.

### ■ Compatible formats and sampling frequencies

- PCM 2-ch: 44.1 kHz/48 kHz/88.2 kHz/96 kHz/176.4 kHz/192 kHz/352.8 kHz/384 kHz (16-bit/24-bit/32-bit)
- DSD 2-ch: 2.8 MHz (DSD64)/5.6 MHz (DSD128)/11.2 MHz (DSD256), compatible with ASIO Native and DoP

Concerning the file formats that can be played, check the formats supported by the applications used on your computer.

## Trademarks

### Trademarks

The trademarks used in this manual are as follows.



This Receiver is compatible with AirPlay 2. iOS 11.4 or later is required.

Use of the Works with Apple badge means that an accessory has been designed to work specifically with the technology identified in the badge and has been certified by the developer to meet Apple performance standards.

Apple, AirPlay, Apple TV, Apple Watch, iPad, iPad Air, iPad Pro, iPhone, Lightning, and iTunes are trademarks of Apple Inc., registered in the U.S. and other countries and regions.

#### App Store

App Store is a service mark of Apple Inc., registered in the U.S. and other countries.

#### Android Google Play

Android and Google Play are trademarks of Google LLC.



The Wi-Fi CERTIFIED™ Logo and Wi-Fi Protected Setup Logo are registered trademark of Wi-Fi Alliance®.

Wi-Fi, Wi-Fi CERTIFIED, Wi-Fi Protected Setup and WPA2 are trademarks or registered trademarks of Wi-Fi Alliance®.



The Bluetooth® word mark and logos are registered trademarks owned by Bluetooth SIG, Inc. and any use of such marks by Yamaha Corporation is under license. Other trademarks and trade names are those of their respective owners.



MusicCast is a trademark or registered trademark of Yamaha Corporation.

#### GPL/LGPL

This product utilizes GPL/LGPL open-source software in some sections. You have the right to obtain, duplicate, modify, and redistribute this open-source code only. For information on GPL/LGPL open source software, how to obtain it, and the GPL/LGPL license, refer to the Yamaha Corporation website

(<https://download.yamaha.com/sourcecodes/musiccast/>).

#### Licenses

For information on the licenses of the third-party software in this product, refer to the following.

[http://\(IP address of this product\\*\)/licenses.html](http://(IP address of this product*)/licenses.html)

\* IP address of this product is checked with MusicCast Controller.

# Specifications

## Specifications

---

The specifications of this unit are as follows.

### Input jacks

#### Analog Audio

- Audio x 4 (including PHONO)

#### Digital Audio

- Optical x 2 (PCM only) (Supported frequencies: 32 kHz/44.1 kHz/48 kHz/88.2 kHz/96 kHz/176.4 kHz/192 kHz)
- Coaxial x 2 (PCM only) (Supported frequencies: 32 kHz/44.1 kHz/48 kHz/88.2 kHz/96 kHz/176.4 kHz/192 kHz)

#### Other jacks

- USB x 1 (USB Type B)
- NETWORK (Wired) x 1 (100Base-TX/10Base-T)

### Output jacks

#### Analog Audio

- Speaker Out x 4 (A L/R, B L/R)
- Pre Out x 1 (L/R)
- Subwoofer Out x 1 (monaural)
- Headphone x 1

#### Other jacks

- YPAO MIC x 1
- TRIGGER OUT x 1

### TUNER

#### Analog Tuner

- [Models for U.K., Europe and Russia]  
DAB/FM with Radio Data System x 1 (TUNER)
- [Model for Australia]  
DAB/FM x 1 (TUNER)
- [Models for other areas]  
FM/AM x 1 (TUNER)

### USB DAC

#### Audio Format

- PCM 2-ch (44.1 kHz/48 kHz/88.2 kHz/96 kHz/176.4 kHz/192 kHz/352.8 kHz/384 kHz (16-bit/24-bit/32-bit))
- DSD 2-ch (2.8 MHz (DSD64)/5.6 MHz (DSD128)/11.2 MHz (DSD256), compatible with ASIO Native and DoP)

## Bluetooth

### Sink Function

- Source Device to this product (ex. Smartphone/Tablet)
- Supported profile
  - A2DP v1.3, AVRCP v1
- Supported codec
  - SBC, AAC

### Source Function

- This product to Sink Device (ex. Bluetooth Headphone)
- Supported profile
  - A2DP v1.3
- Supported codec
  - SBC
- Capable of Play/Stop Operation from Sink Device

### Bluetooth version

- Ver. 4.2

### Wireless output

- Bluetooth Class 2

## Network

### media servers (PC/NAS)

### AirPlay 2

### Internet Radio

### music streaming service

### MusicCast

- Controlled by MusicCast Controller App.
- MusicCast Link function\*
  - \* The following audio distribution is restricted.
  - PCM (352.8 kHz/384 kHz) and DSD
  - AirPlay

### Wi-Fi function

- Capable of WPS by PIN Method and Push-Button-Method
- Available Security Method: WEP, WPA2-PSK (AES), Mixed Mode
- Wireless LAN Standards: IEEE 802.11 a/b/g/n/ac\*
  - \* 20 MHz channel bandwidth only
- Radio Frequency: 2.4/5 GHz

**Audio Section**

Rated Output Power (2-channel driven) (20 Hz to 20 kHz, 0.07% THD)	
• 8 Ω	100 W + 100 W
Dynamic power (IHF)	
• 8 Ω	140 W + 140 W
• 6 Ω	170 W + 170 W
• 4 Ω	220 W + 220 W
• 2 Ω	290 W + 290 W
IEC Output Power (1kHz, 0.07% THD, 8 Ω)	
• [Models for U.K. and Europe]	115 W + 115 W
Maximum Effective Output Power (JEITA, 1 kHz, 10% THD)	
• [Models for U.S.A., Canada, China, Korea, Australia, U.K., Europe, Russia and for Central and South America]	
• 8 Ω	145 W + 145 W
Power Bandwidth (2-channel driven, 0.06% THD, 40 W/8 Ω)	10 Hz to 50 kHz
Damping Factor (1 kHz, 8 Ω)	240 or more
Input Sensitivity / Input Impedance (1 kHz, 100 W/8 Ω)	
• PHONO (MM)	3.5 mVrms/47 kΩ
• CD/LINE1/LINE2	200 mVrms/47 kΩ
Maximum Input Signal Voltage (1 kHz, 0.5% THD)	
• PHONO (MM)	50 mVrms
• CD/LINE1/LINE2	2.8 Vrms
Rated Output Voltage / Output Impedance	
• PRE OUT	1.0 Vrms/1.2 kΩ
• SUBWOOFER OUT (30 Hz)	4.3 Vrms/1.2 kΩ
Headphone Jack Rated Output Power (1 kHz, 8 Ω)	27 mW
Frequency Response	
• 20 Hz to 20 kHz (CD etc.)	0±0.5 dB
• 10 Hz to 100 kHz (CD etc., Pure Direct ON)	0±1.0 dB
RIAA Equalization Deviation (Pure Direct ON)	
• PHONO	±0.5 dB
Total Harmonic Distortion Plus Noise (2-channel driven) (Pure Direct ON)	
• PHONO to PRE OUT (1.0 Vrms)	0.04%
• CD/LINE1/LINE2 to SP OUT (50 W/8 Ω)	0.019%



## APPENDIX > Specifications

---

Signal to Noise Ratio (IHF-A Network) (Pure Direct ON)	
• PHONO (MM)	82 dB
• CD/LINE1/LINE2	100 dB

---

Residual Noise (IHF-A Network) (Pure Direct ON)	
• SP OUT	70 $\mu$ Vrms

---

Channel Separation (JEITA, 1 kHz/10 kHz) (Pure Direct ON)	
• CD/LINE1/LINE2	65 dB/50 dB or more

---

Tone Control Characteristics	
• Bass Boost/Cut	20 Hz/ $\pm$ 10 dB
• Bass Turnover Frequency	300 Hz
• Treble Boost/Cut	20 kHz/ $\pm$ 10 dB
• Treble Turnover Frequency	3.0 kHz

---

Continuous Loudness Control (Attenuation 1 kHz)	-30 dB
---	--------

## FM Section

---

Tuning Range	
• [Models for U.S.A. and Canada]	87.5 MHz to 107.9 MHz
• [Models for Asia, Taiwan and for Central and South America]	87.5/87.50 MHz to 108.0/108.00 MHz
• [Models for other areas]	87.50 MHz to 108.00 MHz

---

50 dB Quiet Sensitivity (IHF, 1 kHz, 100% MOD.)	
• Monaural	3 $\mu$ V (20.8 dBf)

---

Signal to Noise Ratio (IHF)	
• Monaural	69 dB
• Stereo	68 dB

---

Harmonic Distortion	
• Monaural	0.5%
• Stereo	0.6%

---

Antenna Input	75 $\Omega$ unbalanced
---------------	------------------------

## AM Section (Models for U.S.A., Canada, China, Korea, Asia, Taiwan and for Central and South America)

---

Tuning Range	
• [Models for U.S.A. and Canada]	530 kHz to 1710 kHz
• [Models for Asia, Taiwan and for Central and South America]	530/531 kHz to 1710/1611 kHz
• [Models for China and Korea]	531 kHz to 1611 kHz

Antenna Input	Loop Antenna
---------------	--------------

## DAB Section (Models for U.K., Europe, Russia and Australia)

Tuning Range	174.928 MHz to 239.200 MHz (Band III)
--------------	---------------------------------------

Support Audio Format	MPEG 1 Layer II/MPEG-4 HE-AAC v2 (aacPlus v2)
----------------------	---

Antenna Input	75 $\Omega$ unbalanced
---------------	------------------------

## General

Power Supply	
<ul style="list-style-type: none"> <li>• [Models for U.S.A. and Canada]</li> <li>• [Models for Taiwan and for Central and South America]</li> <li>• [Model for China]</li> <li>• [Model for Korea]</li> <li>• [Model for Australia]</li> <li>• [Models for U.K., Europe and Russia]</li> <li>• [Model for Asia]</li> </ul>	<ul style="list-style-type: none"> <li>AC 120 V, 60 Hz</li> <li>AC 110 V, 60 Hz</li> <li>AC 220 V, 50 Hz</li> <li>AC 220 V, 60 Hz</li> <li>AC 230 to 240 V, 50 Hz</li> <li>AC 230 V, 50 Hz</li> <li>AC 220 to 240 V, 50/60 Hz</li> </ul>

Power Consumption	250 W
-------------------	-------

Standby Power Consumption*	
<ul style="list-style-type: none"> <li>• Network Standby ON, Bluetooth Standby ON <ul style="list-style-type: none"> <li>• Wi-Fi (5 GHz) 2.0 W</li> <li>• Wired 1.6 W</li> </ul> </li> <li>• Network Standby ON, Bluetooth Standby OFF <ul style="list-style-type: none"> <li>• Wi-Fi (5 GHz/2.4 GHz) 1.8 W</li> <li>• Wired 1.6 W</li> </ul> </li> <li>• Network Standby OFF, Bluetooth Standby OFF 0.2 W</li> <li>• Power OFF (the  (Power) Switch on the front panel is OFF) 0.2 W</li> </ul>	

\* This product in Standby may download the new firmware via the network. In this case, the standby power consumption is increased than the shown value.

Maximum Power Consumption (1 kHz, 8 $\Omega$ , 10% THD)	
<ul style="list-style-type: none"> <li>• [Models for Taiwan and for Central and South America]</li> </ul>	450 W

Dimensions (W x H x D)	435 x 151 x 395 mm (17-1/8" x 6" x 15-1/2")
------------------------	--

## APPENDIX > Specifications

---

Reference Dimensions (with wireless antenna upright)

\* Including legs and protrusions

435 x 232 x 395 mm  
(17-1/8" x 9-1/8" x 15-1/2")

---

Weight

11.4 kg (25.2 lb)

\* The contents of this manual apply to the latest specifications as of the publishing date. To obtain the latest manual, access the Yamaha website then download the manual file.

## Default values

### List of default values of the Option menu

Check the following default values of the Option menu of this product.

Volume Trim	
• Input Trim	0.0 dB
Signal info	
• Format	-
• Sampling	-
Auto Preset	-
Clear Preset	-
FM Mode	Stereo
Volume Interlock	Limited
Auto playback	On
PLL	
• For “OPTICAL1”, “OPTICAL2”, “COAXIAL1” or “COAXIAL2” input	Mode 3

## List of default values of the Setup menu

---

Check the following default values of the Setup menu of this product.

---

Network	
• Connection	Wired
• Network Info	-
• IP Address	
• DHCP	On
• DMC Control	Enable
• Network Standby	Auto
• Network Name	-
• Network Update	-
• MCLink Pow Intlck	Off
<hr/>	
Bluetooth	
• Bluetooth	On
• Bluetooth Standby	On
<hr/>	
YPAO	
• Speaker A	-
• Speaker B	-
• Speaker A+B	-
• Speaker Off	-
<hr/>	
Volume	
• Max Volume	0 dB
• Initial Volume	Off
<hr/>	
Auto Power Stdby	On
<hr/>	
ECO Mode	Off
<hr/>	
Display	
• Brightness	3
• Display Sleep Time	30 minutes

## List of default values of the Advanced Setup menu

---

Check the following default values of the Advanced Setup menu of this product.

---

Language	English
Remote ID	ID1
Frequency Step (Models for Asia, Taiwan and for Central and South America)	FM50/AM9
Initialization	-
Sp Impedance	8Ω MIN
Control Knob	-

---

Yamaha Global Site  
<https://www.yamaha.com/>

Yamaha Downloads  
<https://download.yamaha.com/>

© 2023 Yamaha Corporation

Published 04/2024 NV-E0

AV21-0177