

NuQ™ SERIES ENGINEERING INFORMATION

The NuQ-15 is a switchable active/passive full range two-way loudspeaker system designed for use in a wide range of portable speech and music sound reinforcement applications.

The NuQ-15 loudspeaker is designed to work in conjunction with a Turbosound LMS Series digital loudspeaker management system and Turbosound T series amplifiers. This combination provides the optimum performance from the system as well as offering considerable flexibility to readily adapt to varying venue requirements. NuQ systems can also be controlled over a BVNet network using TurboDrive™ control software.

The switchable active/passive NuQ-15 loudspeaker consists of a front loaded 15" neodymium low frequency driver and a 1.4" neodymium high frequency compression driver on a rotatable 80°H x 50°V HF Converging Elliptical Waveguide™, matched with an internal passive crossover network in a reflex-loaded enclosure. Bi-amp mode can be enabled by means of a rear panel switch.

The comparatively short HF horn flare allows physical alignment of the HF and LF devices, and ensures that the wavefront is shaped smoothly while giving excellent pattern control. The waveguide can be rotated through 90° within the enclosure, making it possible to swap the horizontal and vertical

coverage patterns.

The quasi-trapezoidal enclosure is uniquely formed out of pre-bent plywood, which entirely eliminates four cabinet joints and provides additional benefits of superior strength, low weight and reduced internal reflections. The symmetrical cabinet shape creates an additional role as mirrored left/right monitor wedges.

The cabinet includes rigging points for use with optional flying yokes and wall brackets, and also provides compatibility with OmniMount™ wall and ceiling brackets. A pole mount socket is fitted to the bottom of the cabinet for use with 35mm poles and speaker stands.

The cabinet is constructed from 15mm (5/8") birch plywood, screwed and glued together for maximum strength and rigidity, and includes a steel mesh grille backed with reticulated foam. It is finished in durable black semi-matt textured paint; white textured paint is optionally available.

A rear panel connector plate carries two Neutrik Speakon NL4MP connectors for loop in and loop out connections to additional enclosures.



FEATURES

- CEW™ technology**
- Bent plywood construction**
- Rotatable HF waveguide**
- Multiple rigging points**
- Pole mount socket**
- OmniMount™ compatible**

APPLICATIONS

- Front of house**
- Floor monitor**
- Dry hire and rental**
- Theatre**
- Houses of Worship**
- Corporate / industrial**

DIMENSIONS (HxWxD)	712mm x 430mm x 385mm (28" x 16.9" x 15.2")	
NET WEIGHT	26kg (57.2lbs)	
COMPONENTS	1 x 15" (381mm) LF driver, 1 x 1.4" (35mm) HF driver on a Converging Elliptical Waveguide™	
FREQUENCY RESPONSE¹	50Hz - 20kHz ±4dB	
NOMINAL DISPERSION²	80°H x 50°V@-6db points. Rotatable waveguide allows swap of horizontal and vertical pattern	
POWER HANDLING	Passive: 600 watts continuous, 1200 watts program Recommended amplifier power: 1200 watts @ 8 ohms Bi-amp: LF 500 watts continuous, 1000 watts program HF 100 watts continuous, 200 watts program	
SENSITIVITY³	100dB, 1 watt @ 1 metre	
CALCULATED MAX SPL	129dB continuous ⁴ , 135dB peak ⁵	
CROSSOVER	Internal passive crossover at 1k6Hz; 24dB/octave Butterworth	
CONTROLLERS	Turbosound LMS-D24, LMS-D26	
NOMINAL IMPEDANCE	Passive: 8 ohms, Bi-amp LF: 8 ohms, HF: 6 ohms	
CONSTRUCTION	15mm (5/8") birch plywood; rebated, screwed and glued. Finished in black semi-matt textured paint. Two recessed carrying handles. Pole mount socket	
GRILLE	Powder coated perforated steel with acoustically transparent reticulated foam	
CONNECTORS	(2) Speakon NL4MP, wired pin 1+: positive, pin 1-: negative, pins 2+ and 2- n/c	
FLYING HARDWARE	M8 internal rigging points for WB-55B wall brackets M6 internal rigging points for OmniMount™ brackets M10 internal rigging points for flying yokes and eyebolts	
OPTIONS	Optional colour: white textured paint	
SPARES AND ACCESSORIES	LS-1528	15" (381mm) LF loudspeaker
	RC-1528	Recone kit
	CD-213.2	1.4" (35mm) HF compression driver
	RD-213.2	Replacement diaphragm
	PX-NuQ15	Crossover network
	MG-NuQ15	Replacement grille
	WB-55B	Wall bracket
	NuQ FY-15	Flying yoke
	PB-55	Wall bracket, pole mount fixing

Notes

¹Measured on axis

²Average over stated bandwidth

³Characteristic sensitivity as measured to IEC 268-5

⁴Unweighted diode-clipped pink noise. Measured in a half space environment

⁵Verified by subjective listening tests of familiar program material, before the onset of perceived signal degradation

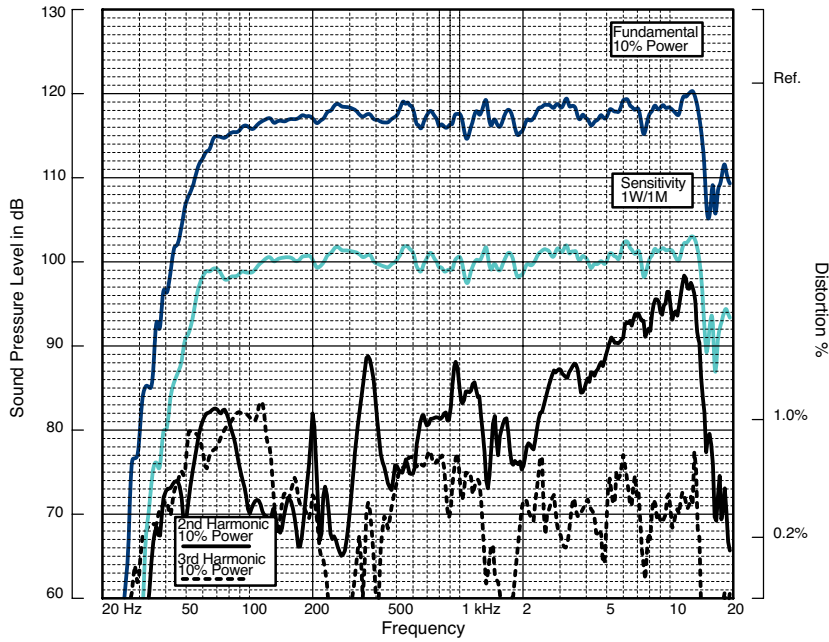

FREQUENCY RESPONSE

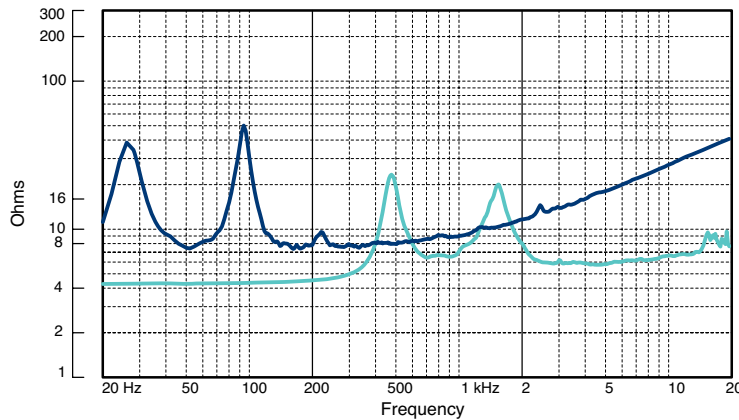

Bi-amped

IMPEDANCE

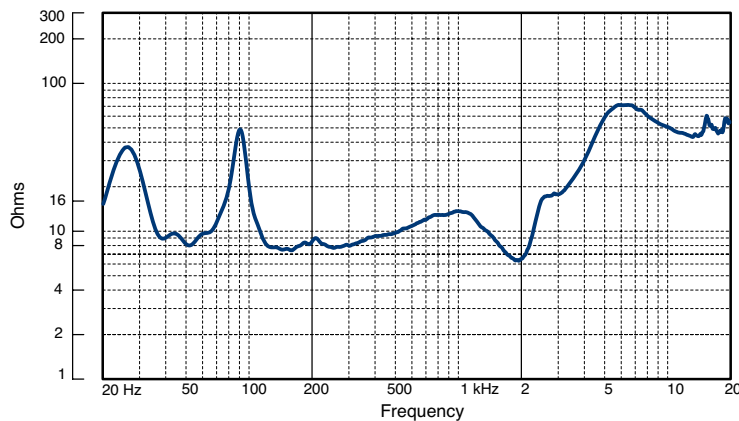

Passive

Impedance A constant current circuit was used to measure the impedance. **Frequency response** The frequency response shown was obtained by feeding a swept sine wave through an unprocessed loudspeaker system in a half space environment. The position of the microphone was vertically on-axis at a distance of 2 metres, then scaled to represent 1 metre. **2nd & 3rd Harmonic Distortion** Distortion measurements were obtained using an Audio Precision harmonic distortion analysis system and comply with AES recommendations for enclosure measurement (AES paper ANSI S4-26-1984). **Data Conversion** All graphs were digitally generated using the APEX custom software system, designed to translate data derived from Audio Precision 'System One' test equipment into AutoCAD™. This program enables graphical information to be plotted to a high degree of accuracy.

NOTES ON MEASUREMENT CONDITIONS

**HORIZONTAL THIRD
OCTAVE POLARS**

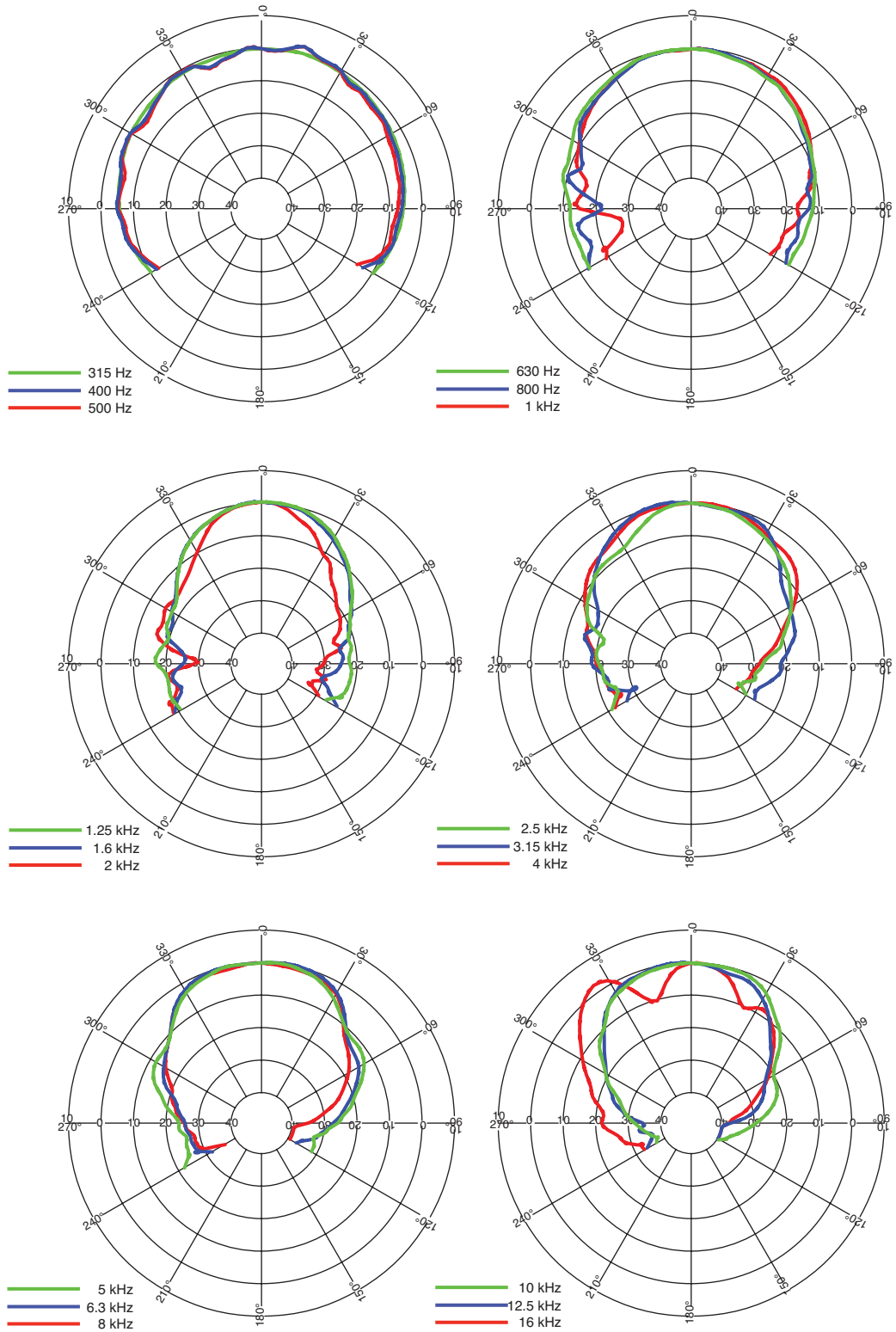

**VERTICAL THIRD
OCTAVE POLARS**

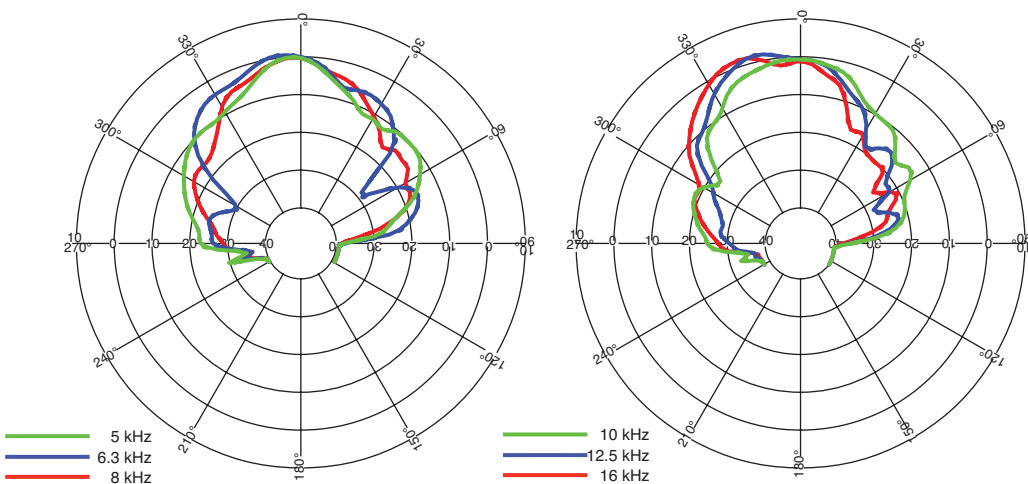
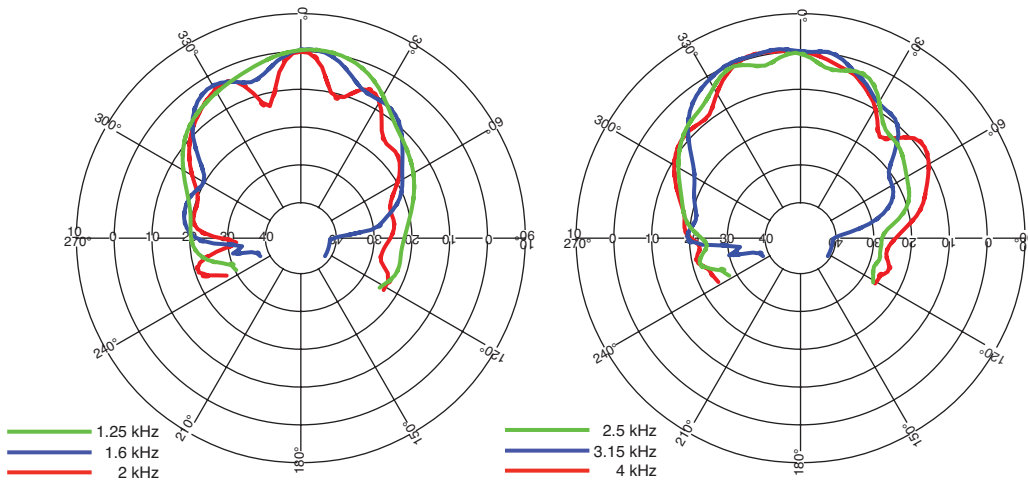
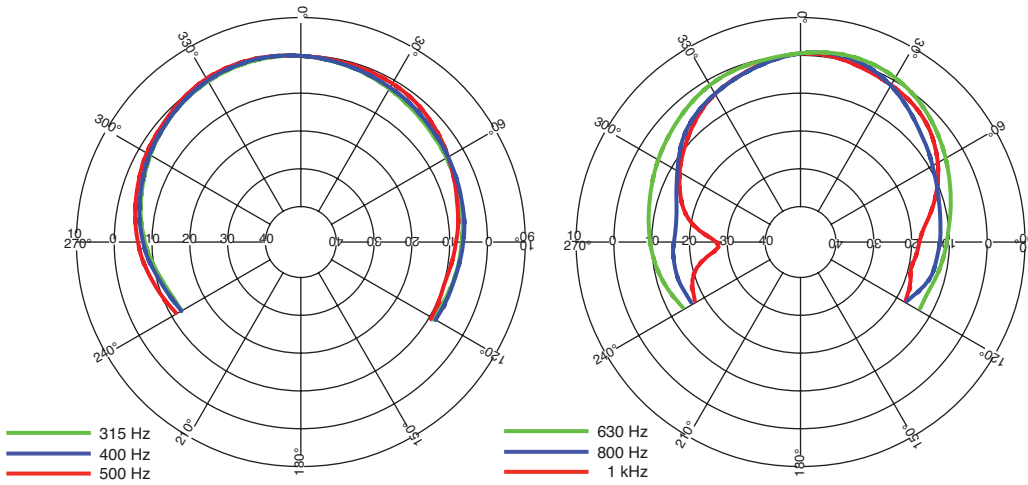

BEAMWIDTH

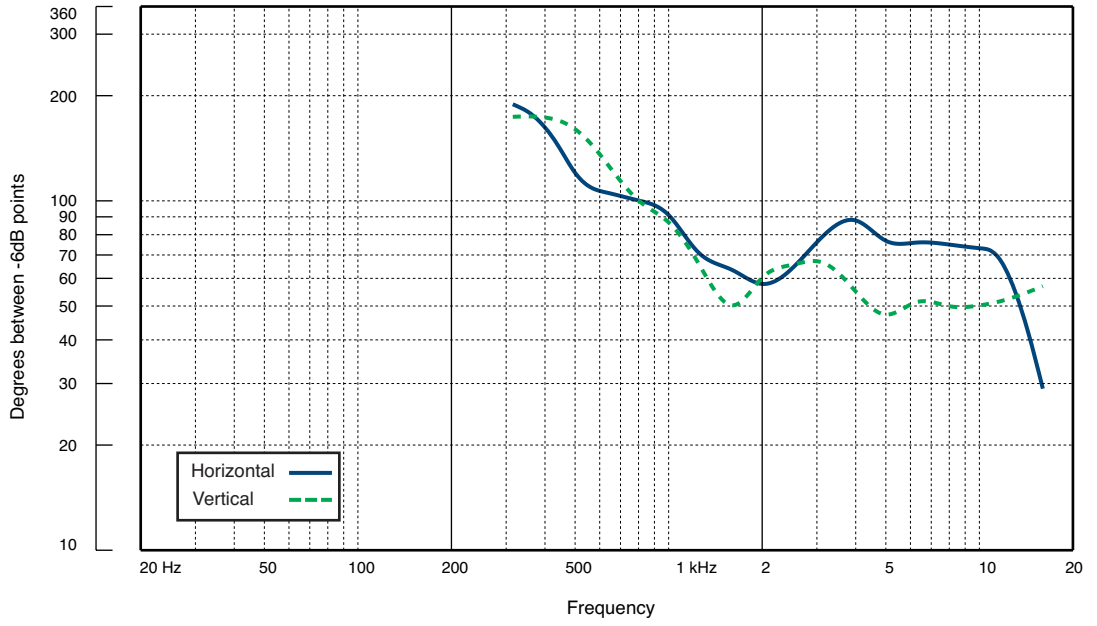

NuQ™ SERIES ENGINEERING INFORMATION

**FLYING AND RIGGING
 HARDWARE**

The cabinet is fitted with rigging points on the top, bottom, sides and rear which allow it to be rigged in a variety of ways to suit differing applications.

An adjustable flying yoke enables the cabinet to be fixed to a ceiling with the ability to rotate and angle downwards. Optional scaffold clamps allow this yoke to be flown from truss.

M8 rigging points are provided on the rear panel for use with WB-55B wall brackets, and M6 rigging points are also provided for use with OmniMount™ 120.0 series brackets. The integral pole mount socket enables the cabinet to be used with standard 35mm tripod stands and poles, or wall-mounted using the universal PB-55 pole bracket.

M10 eyebolts rigging points are also available on the top, sides and bottom of the cabinet to provide an additional method of rigging cabinets in permanent installations.

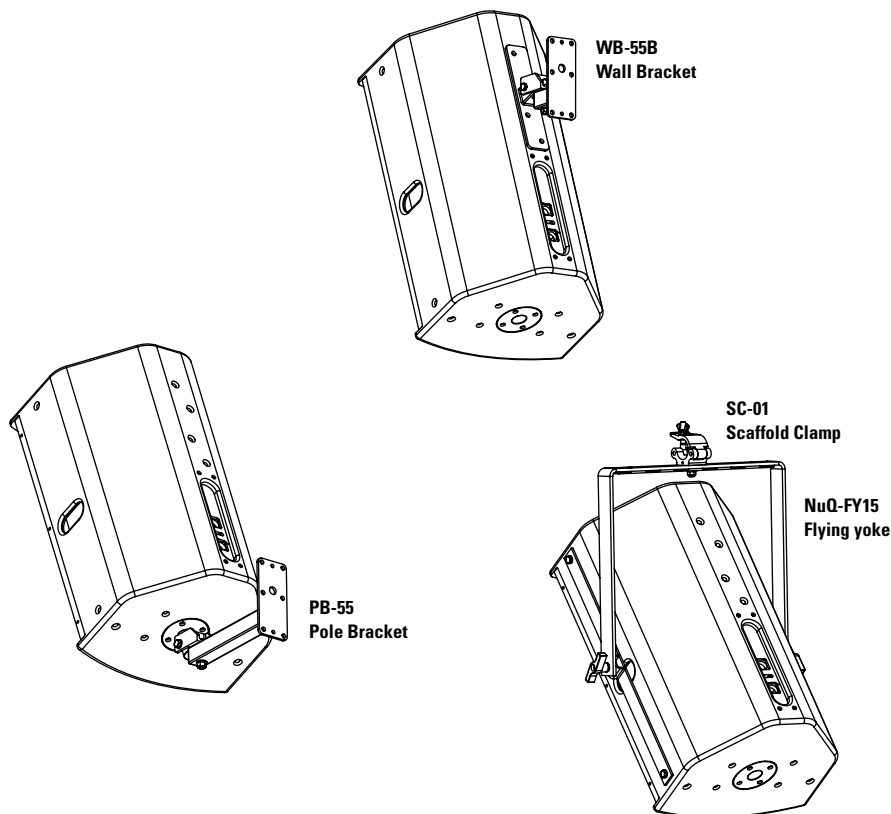

**ARCHITECTURAL
& ENGINEER'S
SPECIFICATIONS**

The system shall be of the full range, switchable active/passive two-way type consisting of one 15" (381mm) LF driver and one 1.4" (35mm) HF driver on a rotatable Converging Elliptical Waveguide™. Performance specifications of a typical production unit when used with a Turbosound LMS series digital loudspeaker management system shall meet or exceed the following: Frequency response, measured with swept sine wave input, shall be flat within ±4dB from 50Hz to 20kHz. Nominal dispersion, at -6dB points, shall average 80°H x 50°V. Nominal impedance shall be 8 ohms. Power handling shall be passive: 600 watts continuous, 1200 watts program; active LF: 500watts continuous, 1000 watts program, HF: 100 watts continuous, 200 watts program. Sensitivity, measured with 1 watt input at 1 metre distance on axis, mean averaged over stated bandwidth, shall be 100dB. Maximum SPL (peak) measured with music program at stated amplifier input shall be 135dB. Dimensions: 712mmH x 430mmW x 385mmD (28"H x 16.9"W x 15.2"D). Weight: 26kg (57.2lbs). The loudspeaker system shall be the Turbosound NuQ-15. No other loudspeaker shall be acceptable unless submitted data from an independent test laboratory verify that the above combined performance / size specifications are equalled or exceeded.

DIMENSIONS

