



Features

- Advanced new Dual Concentric driver design utilizing Omnimagnet technology
- Torus Ogive Waveguide device for improved broadband directivity
- Improved time alignment and phase coherence, delivering even better sonic performance
- High power and high sensitivity with extended frequency response and very low distortion
- Improved LF performance for applications where genuine bottom-end is a must
- Ultra-shallow depth profile for applications where cavity space is restricted
- Low insertion-loss, 30 watt line transformer for a more powerful and dynamic performance
- Convenient front-tapping switch for settings
- Magnetically-adhering grille system for easy custom painting and optional Arco designer grilles for minimal architectural impact
- Four-clamp, self-aligning mounting system
- UV resistant baffle and grille
- Packaged with classic grille, tile rails and C-ring for quick and easy installation and simple stocking logistics

Applications

- Voice Alarm Systems
- Multizone Foreground Music & Paging Systems
- Boardrooms & Offices
- Business Music Systems
- Airports, Convention Centres, Hotels
- Reception / Waiting Rooms
- Houses of Worship
- Retail Outlets / Shopping Malls
- Lounges / Bars
- Cruise Ships
- Courtrooms

Product description

The Tannoy CMS 503DC LP is a wide bandwidth, high power-handling and high sensitivity loudspeaker built around CMS 3.0 – the third generation of Tannoy's revolutionary Ceiling Monitor System technology. Based on an all-new evolution of Tannoy's proprietary Dual Concentric™ point-source driver, the CMS 503DC has been fundamentally re-engineered to deliver wider and more consistent broadband directivity, even greater intelligibility, and a more accurate and linear response. With a greatly reduced back-can depth, the ultra low-profile CMS 503DC LP has been engineered specifically for applications where ceiling cavity dimensions are a critical limiting factor.

This specialized ceiling device retains the exceptional sonic performance of the standard CMS 503DC, in a much shallower profile package, achieving similar back-can volume by virtue of slightly larger diameter (and hole cut-out size). The new Dual Concentric driver design features revolutionary Omnimagnet™ technology and unique patent-pending Torus Ogive Waveguide™ device, together providing more consistent and controlled directivity along with improved high frequency response. Improved time-alignment and greater coherence between LF and HF results in a wider sweet spot for enhanced performance both on and off-axis.

The CMS 503DC LP utilizes a 16 ohm driver, making it ideal for use in high performance low-impedance systems (with optimized performance when used in conjunction with Lab.gruppen LUCIA amplifiers). The low-insertion loss 30 W transformer features convenient front bezel switching for taps at 30 W, 15W and 7.5 W, with an additional 3.75 W tap for traditional constant voltage systems.

The CMS 503DC LP also features extra clamp extension to accommodate thicker ceiling panels, and a locking design that prevents inadvertent over-screwing. Magnetic grille attachment enables easy removal and fitting for custom painting and tapping changes with grilles now available as either traditional style (inset in bezel) or new Arco™ style, which conceals the entire unit for architect-friendly aesthetic appeal.

The CMS 503DC LP is a blind mount loudspeaker device, supplied with an integral back-can, ready to install as a single unit. Comes supplied with classic grille, two tile support rails and one C-ring; Arco grille and plaster (mud) ring are available as optional accessories.

Physical data

Bezel diameter:	274.0 mm (10.79")	Hole Cutout Diameter:	253.0 mm (9.96")
Front of ceiling to rear of backcan	98.6 mm (3.88")		

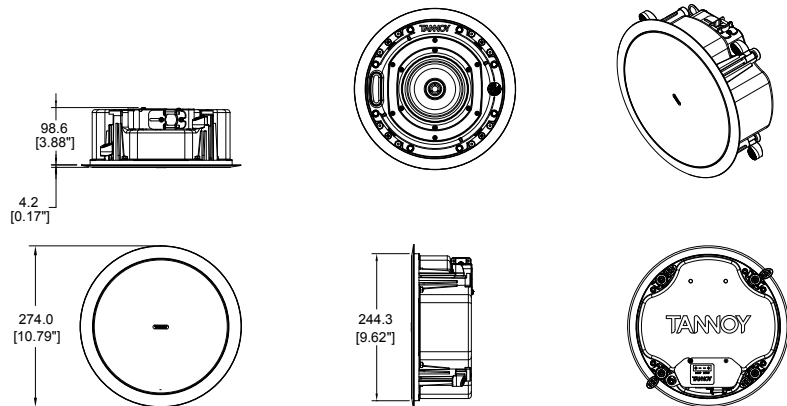

1 m on-axis Frequency Response

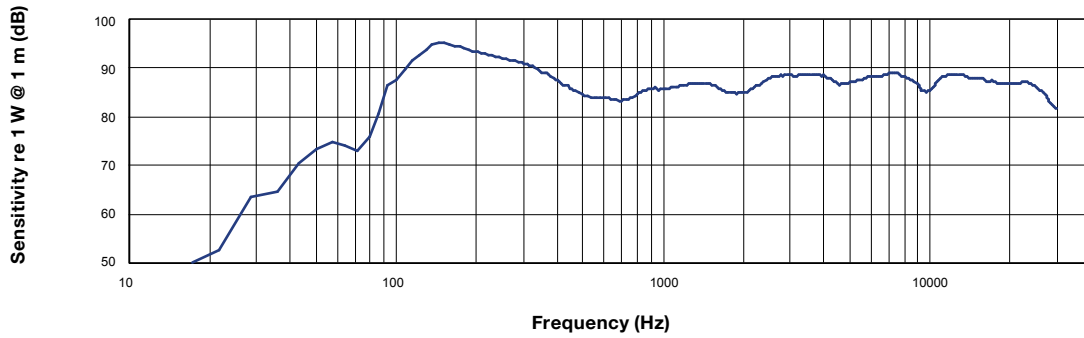

Anechoic Frequency Response

Impedance vs frequency

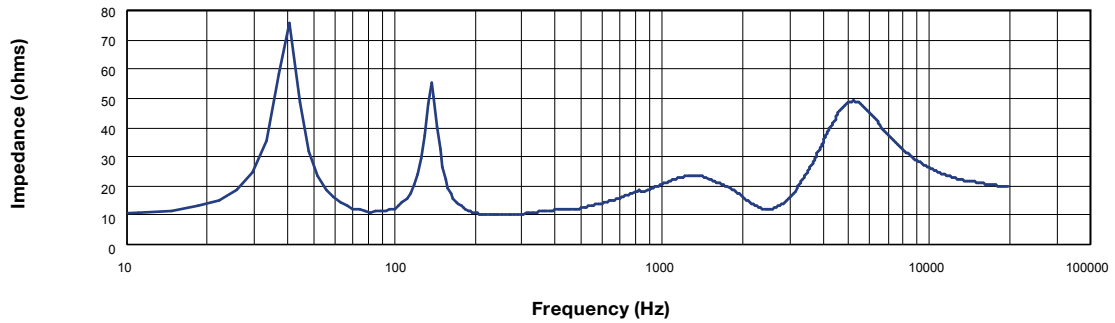

Impedance

Off-axis Frequency Response

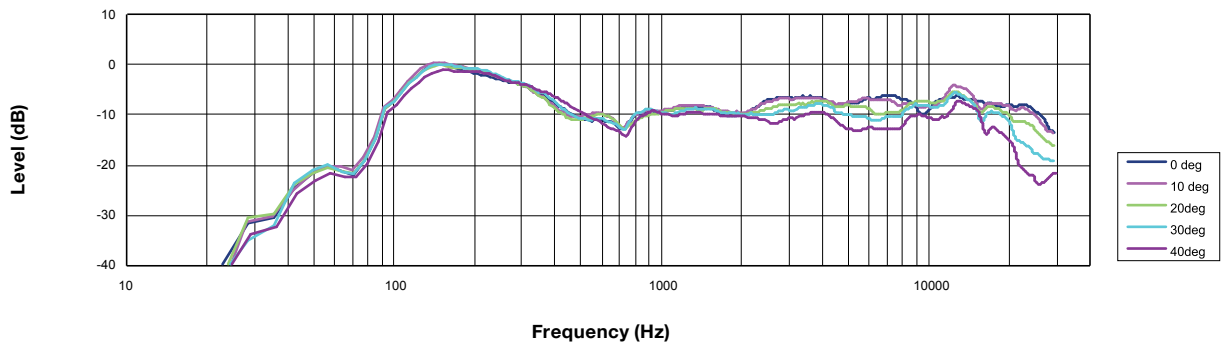

Off Axis Response

Beamwidth vs Frequency

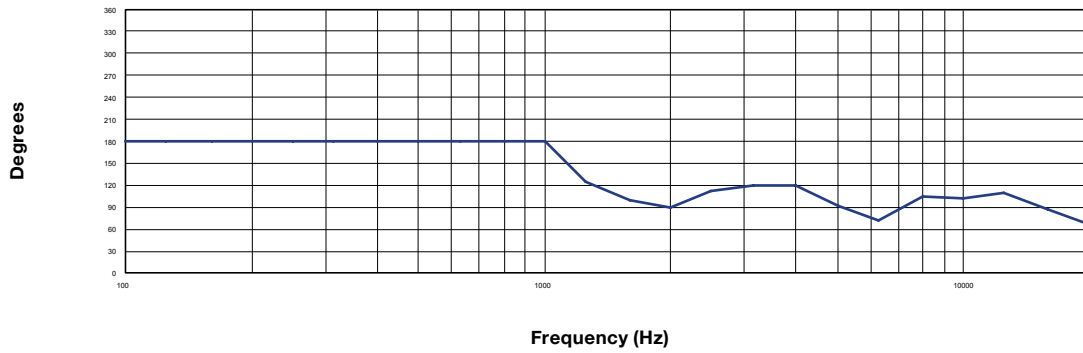

Beamwidth

Directivity Index (DI)

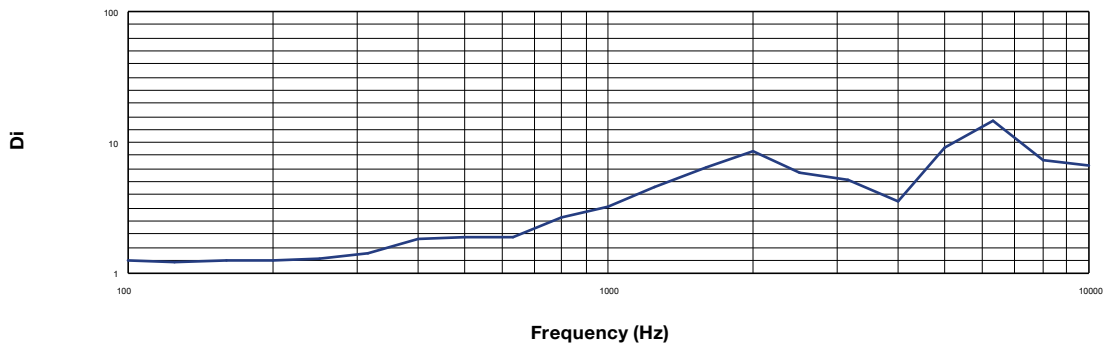

Directivity Index

Technical Data Sheet

Polar plots (1/3 octave)

CMS 503DC LP

100 Hz
125 Hz
160 Hz
200 Hz

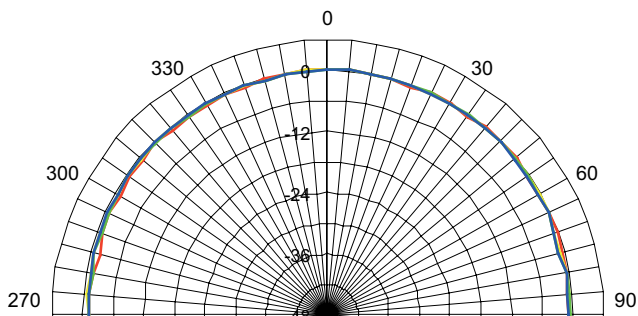

250 Hz
315 Hz
400 Hz
500 Hz

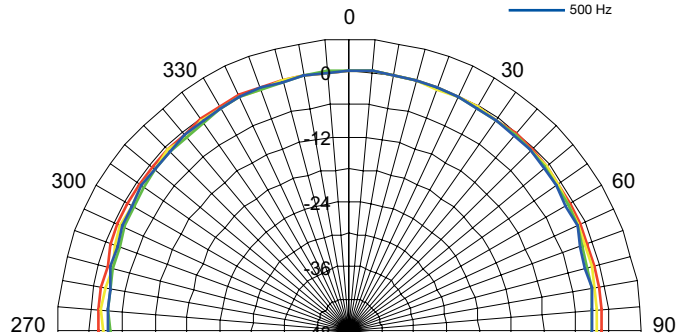

630 Hz
800 Hz
1 kHz
1.25 kHz

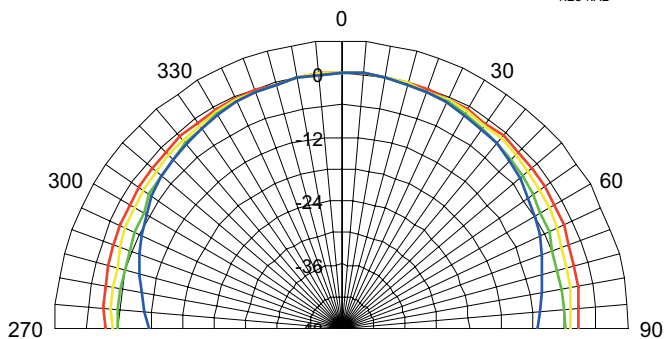

1.6 kHz
2 kHz
2.5 kHz
3.15 kHz

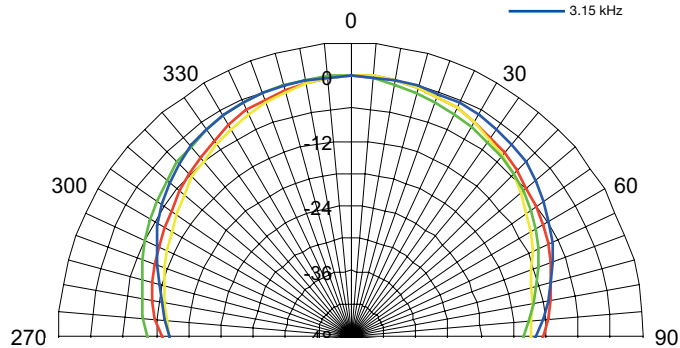

4 kHz
5 kHz
6.3 kHz
8 kHz

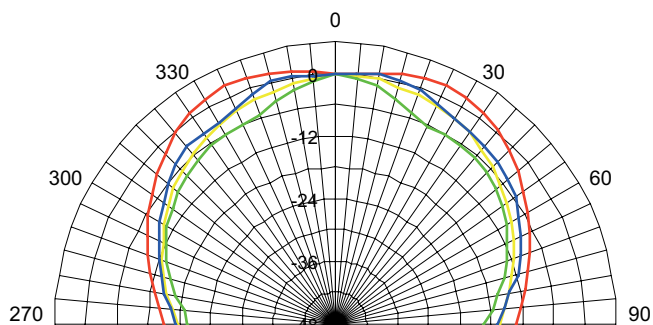

10 kHz
12.5 kHz
16 kHz
20 kHz

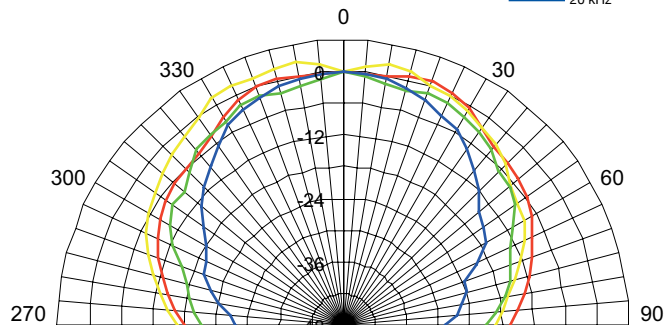

Technical Data Sheet

Specifications

CMS 503DC LP

Performance

Frequency response (-3 dB) ⁽¹⁾	88 Hz - 22 kHz
Frequency range (-10 dB) ⁽¹⁾	77 Hz - 24 kHz
System sensitivity (1 W @ 1 m) ⁽²⁾	89 dB (1 W = 4 V for 16 Ohms)
Nominal Coverage Angle	90 degrees conical
Power Handling ⁽³⁾	
Average	60 W
Programme	120 W
Peak	240 W
Recommended Amplifier Power	120 W @ 16 ohms
Nominal Impedance (Lo, Z)	16 ohms
Rated maximum SPL	
Average	107 dB
Peak	113 dB
Transformer Taps (via front rotary switch)	
70 V	30 W (165 Ω) / 15 W (330 Ω) / 7.5 W (660 Ω) / 3.75 W (1320 Ω) / OFF & low impedance operation
100 V	30 W (330 Ω) / 15 W (660 Ω) / 7.5 W (1320 Ω) / OFF & low impedance operation

Transducers

Dual Concentric point source driver	1 x 130 mm (5.0") Dual Concentric driver, using Omnimagnet technology
Low Frequency	35 mm (1.38") voice coil, treated multi fiber paper pulp cone
High Frequency	20 mm (0.79") PEI dome

Physical

Enclosure	
Backcan	Zinc plated steel
Baffle	Reflex loaded UL 94V-0 rated ABS
Grille	Steel, with weather resistant coating
Safety Features	Safety ring located at rear of enclosure for load bearing safety bond
Clamping Design	Security toggle clamp Min / Max clamping range 9.5 mm (0.37") / 60 mm (2.36") Recommended clamp torque: 1.5 Nm
Cable Entry Options	Cable clamp & squeeze connector for conduit up to 22 mm
Connectors	Removable locking connector with screw terminals with "loop through" facility
Compliance	UL-1480, UL-2043, CE
Dimensions	
Bezel diameter	274.0 mm (10.79")
Front of ceiling to rear of backcan	98.6 mm (3.88")
Hole cutout diameter	253.0 mm (9.96")
Net Weight (ea)	3.3 kg (7.27 lbs)
Included Accessories	C-Ring, tile-bridge kit, paint mask, cut-out template, grille
Optional Accessories	Plaster (mud) ring, Arco grille
Packed Quantity	2

Ordering Information

Part Number	Colour
8001 7930 CMS 503DC LP	White / Paintable
8001 7890 CMS 603 Arco Grille	White / Paintable



LISTED
UL-1480,
UL-2043

Notes:

1. Average over stated bandwidth. Measured in an IEC baffle in an Anechoic Chamber
2. Unweighted pink noise input, measured at 1 metre on axis
3. Long term power handling capacity as defined in EIA - 426B test

A full range of measurements, performance data, CLF and Ease™ Data for CMS 503DC LP can be downloaded from www.tannoypro.com.

Tannoy operates a policy of continuous research and development. The introduction of new materials or manufacturing methods may introduce variations in actual performance; however, actual performance always will equal or exceed the published specifications, which Tannoy reserves the right to alter without prior notice. Please verify the latest specifications when dealing with critical applications.

Copyright (c) 2015 Tannoy Limited. All rights reserved.