

SHURE®

LEGENDARY
PERFORMANCE™

ULX-D

ULXD4D Dual Receiver
ULXD4Q Quad Receiver



ULX-D Digital Wireless Microphone System

General Description

Shure ULX-D™ Digital Wireless offers uncompromising 24-bit audio quality and RF performance, with intelligent, encryption-enabled hardware, flexible receiver options, and advanced rechargeability options for professional sound reinforcement.

A breakthrough in wireless audio quality, Shure digital processing enables ULX-D to deliver the purest reproduction of source material ever available in a wireless system, with a wide selection of trusted Shure microphones to choose from. Extended 20 Hz – 20 kHz frequency range and flat response captures every detail with clarity, presence, and incredibly accurate low end and transient response. With greater than 120 dB, ULX-D delivers wide dynamic range for excellent signal-to-noise performance. Optimized for any input source, ULX-D eliminates the need for transmitter gain adjustments.

ULX-D sets a new and unprecedented standard for spectral efficiency and signal stability. The intermodulation performance of ULX-D is an incredible advancement in wireless performance, enabling a dramatic increase in the number of simultaneous active transmitters on one TV channel. Rock-solid RF signal with zero audio artifacts extends over the entire range. For applications where secure wireless transmission is required, ULX-D offers Advanced Encryption Standard (AES) 256-bit encrypted signal for unbreakable privacy.

For scalability and modular flexibility, ULX-D receivers come in single, dual, and even quad channel versions. The dual and quad channel receivers offer conveniences such as RF cascade, internal power supply, bodypack frequency diversity, audio output channel summing, and Dante™ digital networking for multi-channel audio over Ethernet. All receivers offer High-Density mode for applications where high channel counts are needed, greatly increasing the amount of simultaneous channels possible over one frequency band.

Advanced Lithium-ion rechargeability provides extended transmitter battery life over alkaline batteries, battery life metering in hours and minutes accurate to within 15 minutes, and detailed tracking of battery health status.

Generations ahead of any other available system in its class, ULX-D brings a new level of performance to professional sound reinforcement.

Features

Uncompromising Digital Wireless Audio

- 24-bit/48 kHz digital audio that delivers incredibly clear and accurate reproduction of the source material
- 20 Hz – 20 kHz frequency range with flat response
- Greater than 120 dB dynamic range through the analog outputs
- Built-in limiter circuitry prevents digital audio clipping from excessive signal levels.
- 130 dB dynamic range (typical) using Dante™ digital networked audio
- 60 dB of adjustable system gain easily accessible from the receiver front panel
- No transmitter gain adjustments needed - optimized for any input source
- Wide selection of trusted Shure Microphones

Extremely Efficient and Reliable RF Performance

- Up to 72 MHz overall tuning range (region dependent)
- Up to 17 active transmitters in one 6 MHz TV channel (22 on an 8 MHz TV channel)
- High Density mode enables up to 47 active transmitters in one 6 MHz TV channel (63 in one 8 MHz TV channel), with no audio quality degradation
- Rock-solid signal stability with no audio artifacts over the entire 100 meter line-of-sight range using standard supplied ½ wave antennas
- Selectable 1, 10, and 20 mW transmitter RF output power
- Optimized scanning automatically finds, prioritizes, and selects the cleanest frequencies available

Scalable, Intelligent Hardware

- Single (half-rack), Dual and Quad (full-rack) receiver form factors for any size installation
- AES 256-bit encryption on all channels
- Ethernet networking for streamlined setup across multiple receivers
- Wireless Workbench® 6 software compatible for advanced frequency coordination, monitoring, and control
- AMX/Crestron control
- AXT600 Axient™ Spectrum Manager compatibility
- Rugged metal housing on both transmitters and receiver
- Dual and Quad receivers additionally feature:
 - RF cascade ports, internal power supply, and dual Ethernet ports
 - Dante™ digital networked audio over Ethernet
 - Bodypack Frequency Diversity ensures uninterrupted audio for mission-critical applications
 - Audio summing routes audio signal to multiple outputs

Shure Advanced Power Management

- Adapted from industry-leading Axient™ rechargeable technology
- Lithium-Ion chemistry and intelligent Shure battery circuitry results in rechargeable batteries with zero memory effect and precision metering
- Provides ULX-D transmitters with unmatched 11+ hours of performance time
- Transmitters and receivers display remaining battery life in hours and minutes accurate to within 15 minutes
- AA backwards compatibility

Dual and Quad Receiver Models

The ULXD4 receiver is available in dual channel and quad channel models. Both models share the same feature set and functionality, but differ in the number of channels available and the number of audio outputs.

The descriptions and procedures in this guide are applicable to either the dual or the quad receiver.

Quickstart Instructions

1

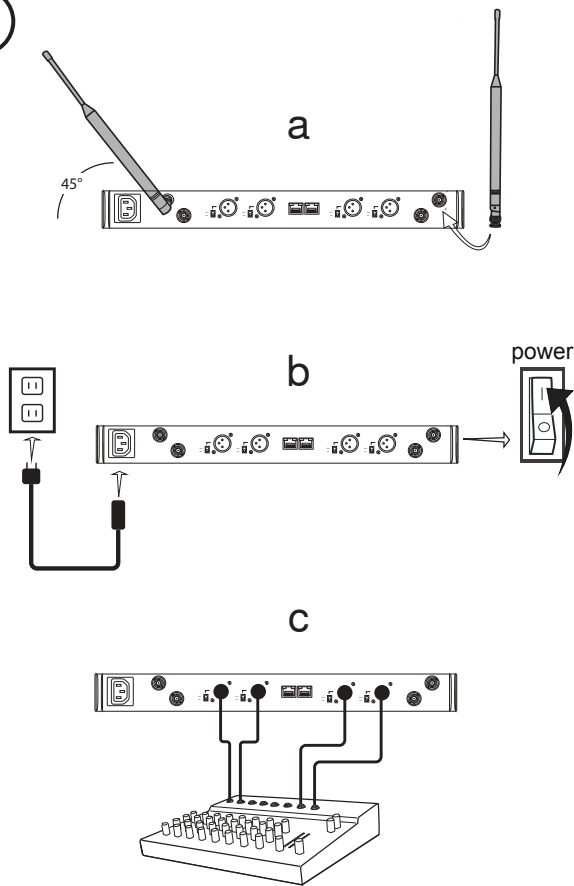

2

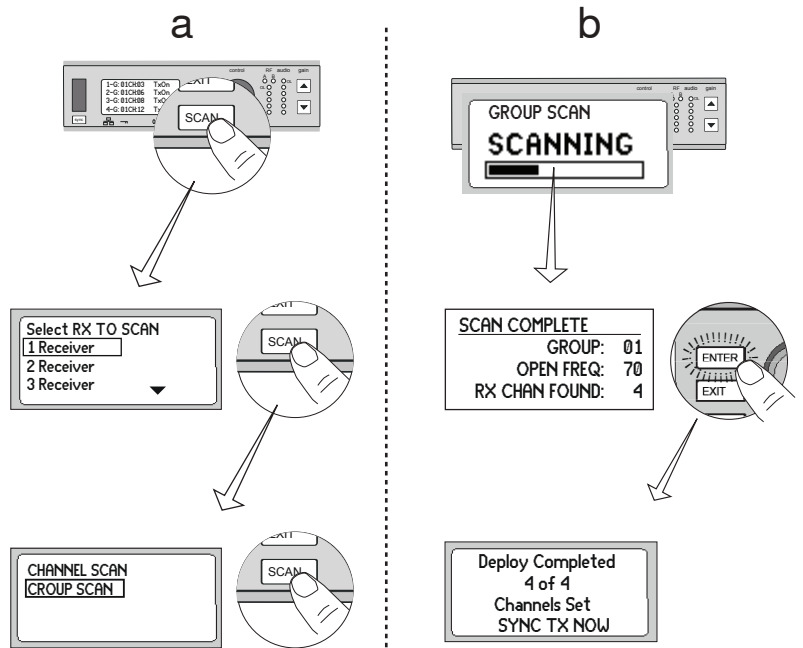

3

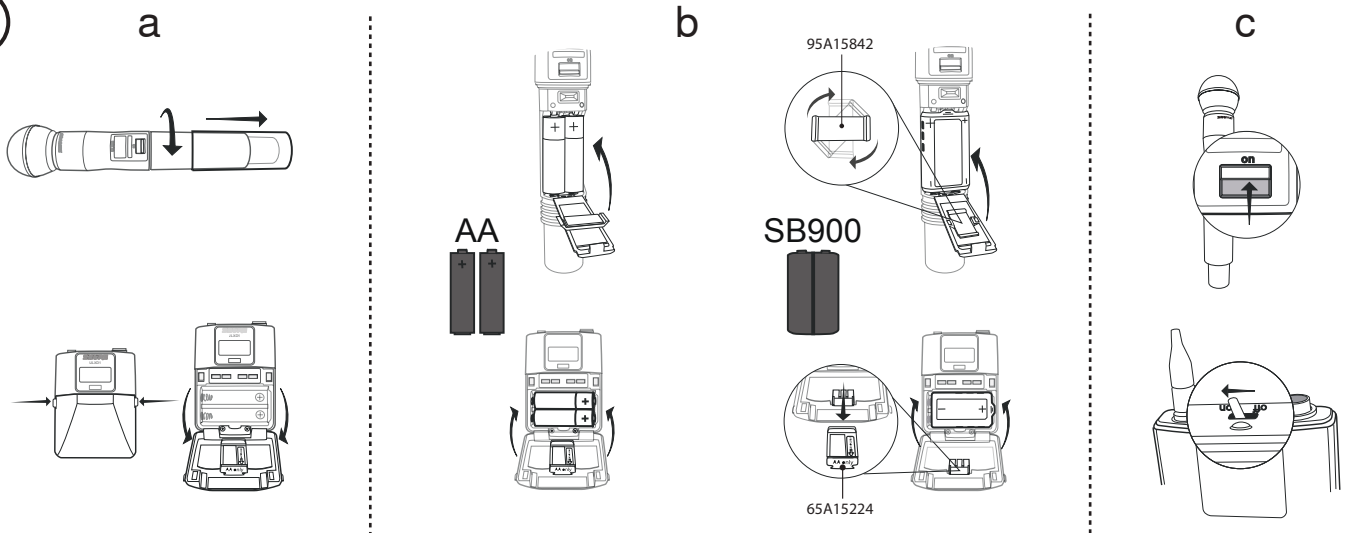

4

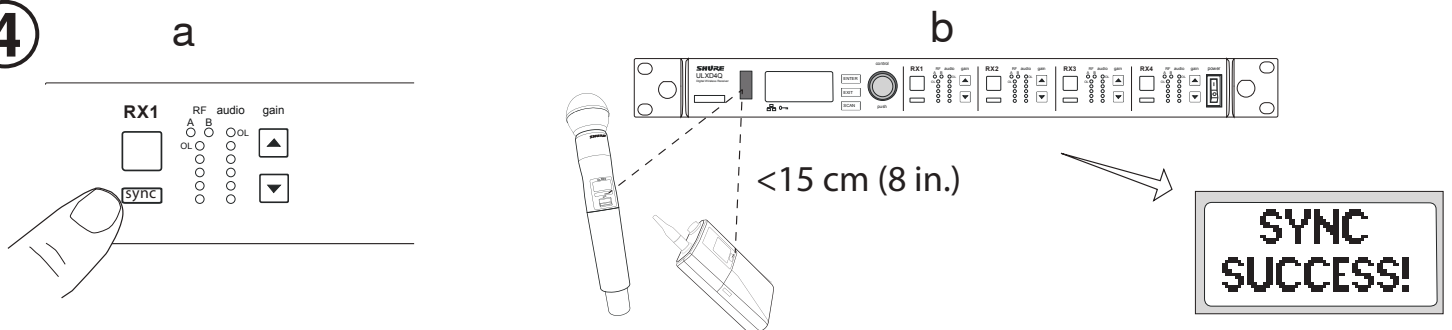

Receiver

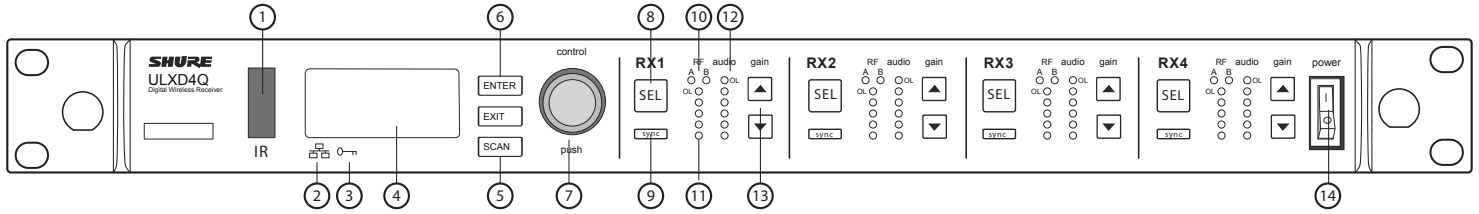

Front Panel

- ① **Infrared (IR) Sync Window**
Sends IR signal to the transmitter for sync.
- ② **Network Icon**
Illuminates when the receiver is connected with other Shure devices on the network. IP Address must be valid to enable networked control.
- ③ **Encryption Icon**
Illuminates when AES-256 encryption is activated.
- ④ **LCD Panel**
Displays settings and parameters.
- ⑤ **Scan Button**
Press to find the best channel or group.
- ⑥ **Menu Navigation Buttons**
Use to navigate and select parameter menus.
- ⑦ **Control Wheel**
 - Push to select a channel or menu item
 - Turn to scroll through menu items or to edit a parameter value
- ⑧ **Channel Select Button**
Press to select a channel.
- ⑨ **Sync Button**
Press the **sync** button while the receiver and transmitter IR windows are aligned to transfer settings from the receiver to the transmitter.
- ⑩ **RF Diversity LEDs**
Indicate antenna status:
 - Blue = normal RF signal between the receiver and transmitter
 - Red = interference detected
 - Off = No RF connection between the receiver and transmitter

- ⑪ **RF Signal Strength LEDs**
Indicate the RF signal strength from the transmitter:
 - Amber = Normal (-90 to -70 dBm)
 - Red = Overload (greater than -25 dBm)

- ⑫ **Audio LEDs**
Indicate average and peak audio levels:

LED	Audio Signal Level	Description
Red (6)	-0.1 dBFS	Overload/ limiter
Yellow (5)	-6 dBFS	Normal peaks
Yellow (4)	-12 dBFS	
Green (3)	-20 dBFS	Signal Present
Green (2)	-30 dBFS	
Green (1)	-40 dBFS	

Note: In Frequency Diversity mode, simultaneous blinking of the red and yellow audio LEDs indicates that diversity audio has been routed to this channel.

- ⑬ **Gain Buttons**
Press the **▲ ▼ gain** buttons on the front of the receiver to incrementally adjust gain from -18 to +42 dB.
- ⑭ **Power Switch**
Powers the unit on or off.

Note: the receiver will not output audio unless one blue LED is illuminated.

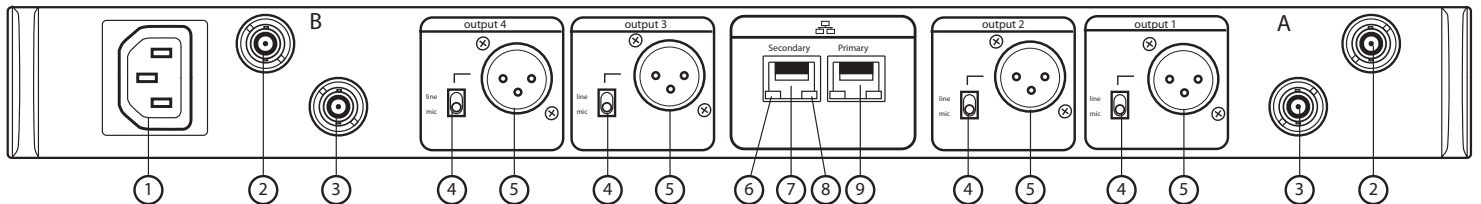

Back Panel

- ① **AC Power Input**
IEC Connector, 100 - 240 V AC.
- ② **RF Antenna Diversity Input Jack (2)**
For antenna A and antenna B.
- ③ **RF Cascade Jack (2)**
Passes the RF signal from Antenna A and Antenna B to one additional receiver.
- ④ **Mic/Line Switch (one per channel)**
Applies a 30 dB pad in mic position.
- ⑤ **Balanced XLR Audio Output (one per channel)**
Connect to a mic or line level input.
- ⑥ **Network Status LED (Green)**
One per network port.
 - Off = no link
 - On = network link
 - Flashing = network link active
- ⑦ **Ethernet/Dante Network Secondary Port**
Connect to an Ethernet network to enable remote device control via WWB6 software. Also carries Dante digital audio and control signals for audio distribution, monitoring, and recording - see Dante Network topic.
- ⑧ **Network Speed LED (Amber)**
One per network port.
 - Off = 10/100 Mbps
 - On = 1 Gbps
- ⑨ **Ethernet/Dante Network Primary Port**
Connect to an Ethernet network to enable remote device control via WWB6 software. Also carries Dante digital audio and control signals for audio distribution, monitoring, and recording - see Dante Network topic.

Transmitters

① Power LED

- Green = unit is powered on
- Red = low battery or battery error (see Troubleshooting)
- Amber = power switch is disabled

② On/Off Switch

Powers the unit on or off.

③ SMA Connector

Connection point for RF antenna.

④ LCD Display:

View menu screens and settings. Press any control button to activate the backlight.

⑤ Infrared (IR) Port

Align with the receiver IR port during an IR Sync for automated transmitter programming.

⑥ Menu Navigation Buttons

Use to navigate through parameter menus and change values.

exit	Acts as a 'back' button to return to previous menus or parameters without confirming a value change
enter	Enters menu screens and confirms parameter changes
▼▲	Use to scroll through menu screens and to change parameter values

⑦ Battery Compartment

Requires Shure SB900 rechargeable battery or 2 AA batteries.

⑧ AA Battery Adapter

- Handheld: rotate and store in the battery compartment to use a Shure SB900 battery
- Bodypack: remove to accommodate a Shure SB900 battery

⑨ Bodypack Antenna

For RF signal transmission.

⑩ Integrated Antenna

For RF signal transmission.

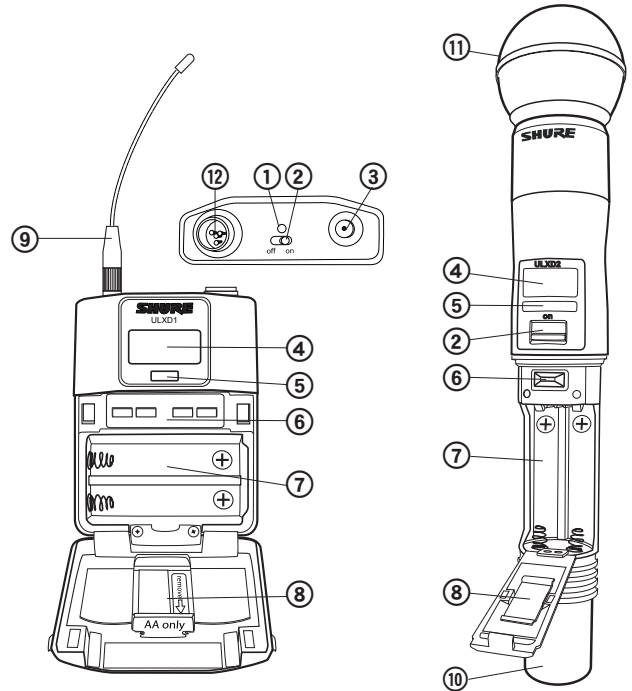

⑪ Microphone Cartridge

See Optional Accessories for a list of compatible cartridges.

⑫ TA4M Input Jack

Connects to a 4-Pin Mini Connector (TA4F) microphone or instrument cable.

Advanced Transmitter Features

RF MUTE

Use this to turn on a transmitter without interfering with the RF spectrum.

Press and hold the **exit** button during power-on until **RF MUTED** is displayed. To un-mute, restart the transmitter.



Transmitter Input Clip

The following warning displays on the receiver LCD panel when the transmitter input is clipped:



To correct, set **MIC.OFFSET** to 0 dB and if necessary, attenuate the signal source.

If the source cannot be attenuated while using a bodypack transmitter, select **INPUT PAD** from the main menu to attenuate the input signal by 12 dB.

MIC.OFFSET

MIC.OFFSET compensates for signal level differences between transmitters that share the same receiver channel.

Set the offset gain on a low signal level transmitter to match a louder transmitter: **UTILITY > MIC.OFFSET**

Note: For normal gain adjustments, use the receiver gain buttons.

Menu Screens

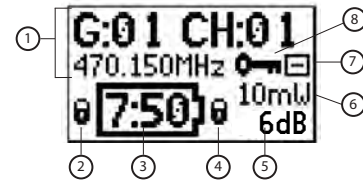
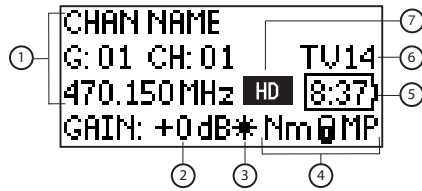

Receiver Channel

- ① **Receiver Information**
Use **DEVICE UTILITIES > HOME INFO** to change the home screen display.
- ② **Gain Setting**
-18 to +42 dB, or Mute.
- ③ **Mic. Offset Indicator**
Indicates offset gain is added to the transmitter.
- ④ **Transmitter Settings**
The following information cycles when a transmitter is tuned to the receiver's frequency:
 - Transmitter Type
 - Input Pad (Bodypack only)
 - RF Power Level
 - Transmitter Lock Status
- ⑤ **Battery Runtime Indicator**
Shure SB900 battery: runtime is displayed in minutes remaining.
AA batteries: runtime is displayed with a 5-bar indicator.
- ⑥ **TV Channel**
Displays the TV channel that contains the tuned frequency.
- ⑦ **High Density Mode Icon**
Displayed when High Density mode is enabled.

Transmitter Setting Icons

Display Icon	Transmitter Setting
	Bodypack input is attenuated 12 dB
	Offset gain is added to the transmitter
Lo	1 mW RF power level
Nm	10 mW RF power level
Hi	20 mW RF power level
M	Menu is locked
P	Power is locked
-No Tx-	No RF connection between a receiver and transmitter or transmitter OFF

Transmitter

- ① **Transmitter Information**
Scroll **▲▼** at the home screen to change the display.
- ② **Power Lock Indicator**
Indicates power switch is disabled.
- ③ **Battery Runtime Indicator**
Shure SB900 battery: runtime is displayed in minutes remaining.
AA Batteries: runtime is displayed with a 5-bar indicator.
- ④ **Menu Lock Indicator**
Indicates menu navigation buttons are disabled.
- ⑤ **Mic. Offset**
Displays microphone offset gain value.
- ⑥ **RF Power**
Displays RF power setting or High Density mode icon (if enabled).
- ⑦ **Bodypack Input Pad**
The input signal is attenuated 12 dB.
- ⑧ **Encryption Icon**
Indicates encryption is enabled on the receiver and has been transferred to the transmitter from a sync.

Receiver Home Screen

The home screen displays the following information for each receiver channel:

- Group and Channel
- Transmitter Status: **NoTx** or **TxOn**, battery icon/remaining battery life

Press the **SEL** button to access a channel menu screen.

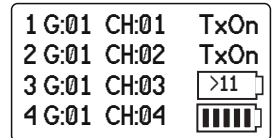

Home Screen Display Options

Receiver

The **HOME INFO** menu provides options to change the information shown on the receiver home screen:

DEVICE UTILITIES > HOME INFO

Use the control wheel to select one of the following screen displays.

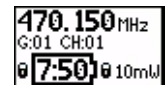
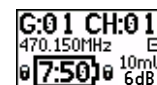
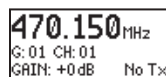
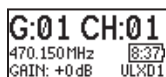

Transmitter

Home Screen: Press the **▲▼** arrows at the home menu to display one of the following screens:

Batteries

The transmitter runs on two AA batteries or the Shure SB900 rechargeable battery. Use the included AA battery adapter when using batteries other than the Shure SB900.

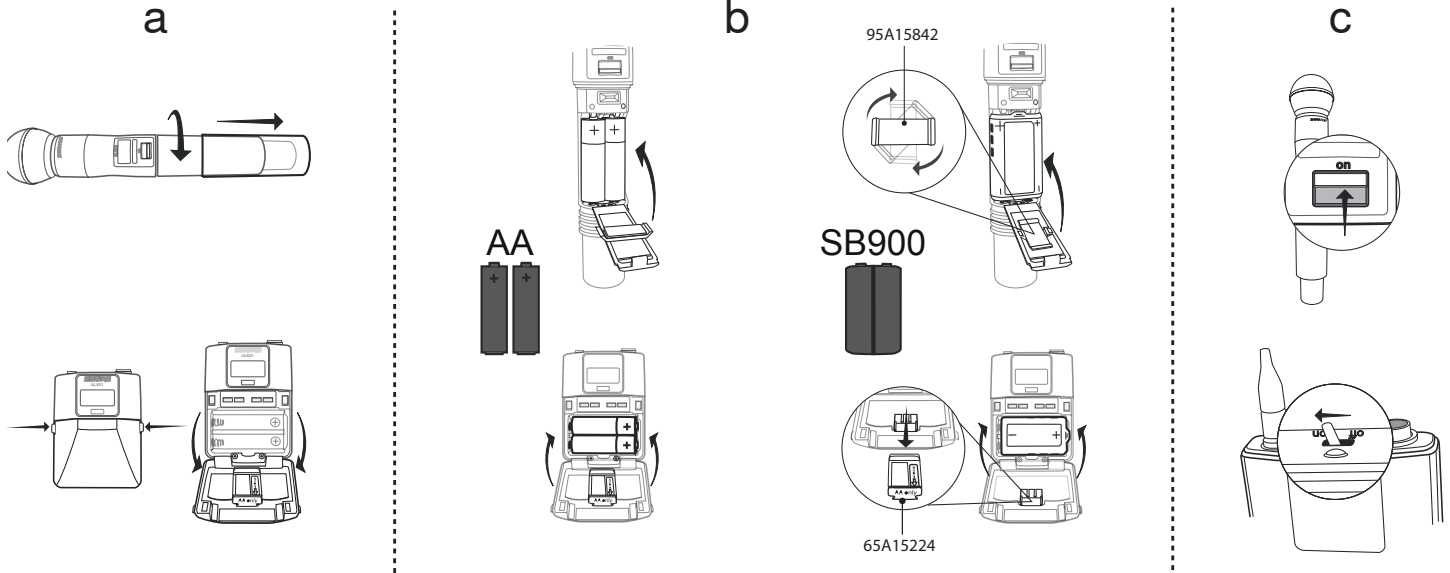







AA Batteries

 A 5-segment icon on the receiver and transmitter menu screens indicates battery charge.

For accurate battery runtime monitoring, set the transmitter to the appropriate battery type: **UTILITY > BATTERY > SET.AA.TYPE**.

AA Alkaline Battery Runtime Chart (h:mm)

Battery Indicator	RF Power Setting	
	1/10 mW	20 mW
	11:00 to 9:35	5:30 to 4:55
	9:35 to 7:15	4:55 to 4:00
	7:15 to 4:45	4:00 to 2:30
	4:45 to 2:25	2:30 to 1:45
	2:25 to 00:45	1:45 to 0:25
	00:45 to 00:20	00:25 to 00:10

AA Battery Adapter

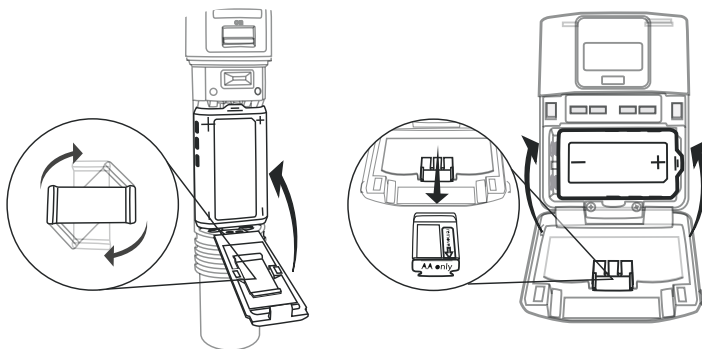

Handheld: Rotate and store the adapter in battery door when using Shure SB900

Bodypack: Remove the adapter when using the Shure SB900

Shure SB900 Rechargeable Battery

 When using an SB900 rechargeable battery, the receiver and transmitter home screens display the number of hours and minutes remaining.

Detailed information for the SB900 is displayed in the receiver **BATTERY INFO** menu and the transmitter menu: **UTILITY > BATTERY > BATT. STATS**

HEALTH: Displays battery health as a percentage of the charge capacity of a new battery.

CHARGE: Percentage of a full charge

CYCLES: Number of times the battery has been charged

TEMP: Battery temperature in Celsius and Fahrenheit

HEALTH:	90%
CHARGE:	80%
CYCLES:	100
TEMP:	10°C / 50°F

Note: For additional rechargeable battery information, visit www.shure.com.

Shure SB900 Runtime

1 mW	10 mW	20 mW
>11 hours	>11 hours	>7 hour

Installing the Battery Contact Cover

Install the included battery contact cover (65A15947) on the handheld transmitter to prevent light reflection in broadcast and performance situations.

1. Align the cover as shown.
2. Slide the cover over the battery contacts until it is flush with the transmitter body.

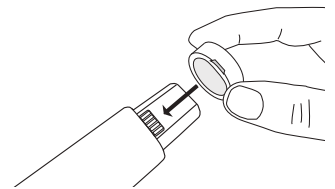

Note: Slide the cover off before inserting the transmitter in the battery charger.

Setting Gain

Adjust gain at the receiver so that the average signal levels are solid green and yellow with peaks that occasionally trigger the red overload LED. Attenuate the gain if the signal overloads repeatedly.

Set the XLR output to line-level when possible to optimize sound system noise performance.

System Gain Control

The gain control on the receiver sets the audio signal level for the entire system. This allows adjustments to be made during a live performance. It is not necessary to change the gain on the transmitter (mic offset) to optimize the gain structure. Any required changes to gain should be made from the receiver.

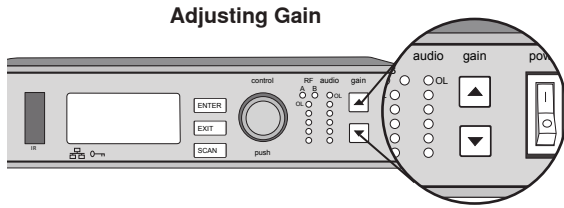

Press the ▲▼ gain buttons on the front of the receiver to incrementally adjust gain from -18 to +42 dB.

Large Gain Adjustments

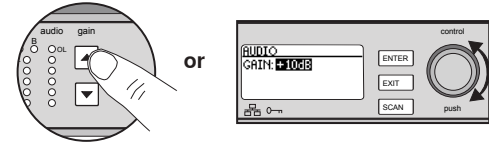

Press and hold a gain button

Use the control wheel in the AUDIO menu

Reading the Audio Meter

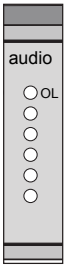

Audio peaks illuminate the LEDs for 1 second hold time. The RMS signal is displayed in real time.

OL (Overload) LED: Illuminates red when the internal limiter is engaged, preventing digital clipping.

Mute

To mute the audio, use Shure Wireless Workbench® software or a third-party control device.

Receiver Output Level

The following table describes the typical total system gain from the audio input to the receiver outputs:

Output Jack	System Gain (gain control = 0dB)
XLR (line setting)	+24 dB
XLR (mic setting)	-6 dB*

*This setting matches a typical wired SM58 audio signal level.

RF

Transmitter RF Power

Reference the following table for setting RF Power:

RF Power Setting	System Range	Application
1 mW	33 m (100 ft.)	For increased channel reuse at close distances
10 mW	100 m (330 ft.)	Typical setups
20 mW	>100 m (330 ft.)	For hostile RF environments or long-distance applications

Note: Using the 20 mW setting decreases the transmitter battery runtime and reduces the number of compatible systems.

Interference Detection

Interference Detection monitors the RF environment for potential sources of interference which can cause audio dropouts.

When interference is identified, the RF LEDs illuminate red and the following warning displays on the receiver LCD panel.

INTERFERENCE!

If the warning display persists or the audio drops out repeatedly, perform a Scan and Sync at the first opportunity to find a clear frequency.

Scan and Sync

Use this procedure to tune a receiver and transmitter to the best open channel.

Important! Before you begin:

Turn off all transmitters for the systems you are setting up. (This prevents them from interfering with the frequency scan.)

Turn on the following potential sources of interference so they are operating as they would be during the presentation or performance (the scan will detect and avoid any interference they generate).

- Other wireless systems or devices
- Computers
- CD players
- Large LED panels
- Effects processors

1. Press the **SEL** button to select a channel.
2. Perform a channel scan on the receiver: **SCAN > GROUP SCAN**.
3. Press **SCAN** to start the scan. **SCANNING** appears on the LCD during the scan.
4. After the scan completes, the receiver displays the group with the most available frequencies. Press the flashing **ENTER** button to deploy frequencies to each receiver channel.
5. Power on the ULXD transmitter.
6. Press the **sync** button on the receiver.
7. Align the IR windows until the receiver IR port illuminates red.
8. When complete, **SYNC SUCCESS!** appears. The transmitter and receiver are now tuned to the same frequency.

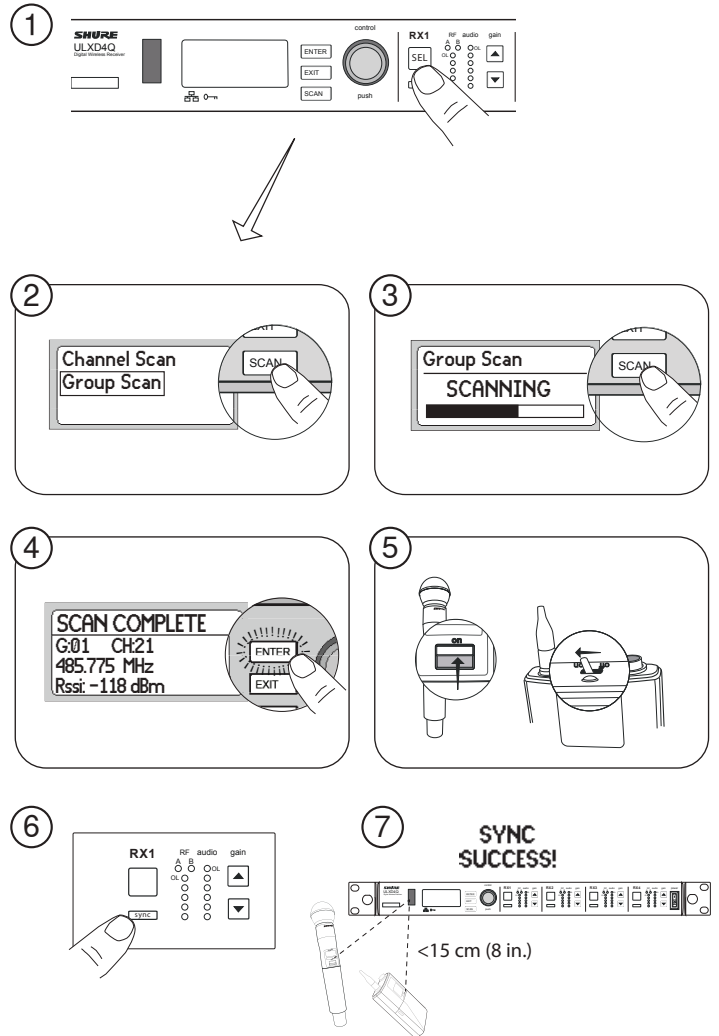

Manual Frequency Selection

To manually adjust group, channel, or frequency:

1. Press **SEL** to choose a receiver channel and navigate to the **RADIO** menu.
2. Use the control wheel to adjust the group, channel, or frequency.
3. Press **ENTER** to save changes.

Multiple System Setup

A setup using networked receivers is the fastest and easiest way to distribute the best open channel to each system. See Networking ULX-D Receivers for networking details.

Note: Networked receivers must all be within the same frequency band.

Networked Receivers

1. Turn on all receivers.
2. Conduct a group scan on the first receiver to find available frequencies in each group: **SCAN > GROUP SCAN**.
3. Press **ENTER** to accept the group number and automatically assign the next best channel to each receiver on the network. The receiver LEDs will flash when a frequency has been assigned.
4. Turn on a transmitter and sync to the receiver.

Important! Leave the transmitter on and repeat this step for each additional system.

Non-networked Receivers

1. Turn on all receivers.
2. Conduct a group scan on the first receiver to find available frequencies in each group: **SCAN > SCAN > GROUP SCAN > SCAN**.
3. When the scan is complete, use the control wheel to scroll through each group. Press **ENTER** to select a group that has enough available frequencies for all channels in the system.
4. Sync a transmitter to each receiver channel.

Important! Leave all transmitters on use the following steps to set up additional receiver channels:

1. Set each additional receiver channel to the same group as the first receiver: **RADIO > G:**
2. Conduct a channel scan to find available frequencies within the group: **SCAN > SCAN > CHANNEL SCAN > SCAN**
3. When the scan is complete, press **ENTER** to assign frequencies to each receiver channel.
4. Sync a transmitter to each receiver channel.

High Density Mode

High Density mode creates additional bandwidth for more channels in crowded RF environments. Frequency efficiency is optimized by running at 1 mW RF transmit power and narrowing the modulation bandwidth, allowing for the channel spacing to be reduced from 350 kHz to 125 kHz. Transmitters can be positioned on adjacent channels with unsubstantial intermodulation distortion (IMD).

High Density mode is ideal for applications where many channels are needed in a confined area, transmission distances are short, and the number of available frequencies is limited. Up to 30 meters of range is available in High Density mode.

Setting the Receiver to High Density Mode

To set the receiver to High Density mode:

DEVICE UTILITIES > ADVANCED RF > HIGH DENSITY

Use the control wheel to set **HIGH DENSITY** to **ON**.

When prompted, sync the transmitter and receiver to enable **HIGH DENSITY** mode.

Note: When the receiver is in **HIGH DENSITY** mode, the following indicators are shown on the receiver display:

- The **HD** icon will appear on the receiver display
- The receiver band name will be shown with an "HD" added. (example: The G50 band will appear as G50HD)
- The transmitter group and channel are assigned letters instead of numbers (example: G:AA CH:AA)

Best Practices for High Density Mode

- When band planning, position ULX-D High Density channels in a range of frequencies separated from other devices.
- Use a separate RF zone for ULX-D High Density channels to prevent intermodulation distortion from other devices.
- During High Density channel scanning, turn on all other transmitters and move them to their intended position.
- Perform a walk test to verify transmitter range
- If using custom groups, the groups loaded into the receiver must be compatible with High Density mode

Frequency Diversity

Frequency Diversity is an advanced ULX-D receiver feature that safeguards against loss of audio signal caused by RF interference or by power loss in a transmitter.

In Frequency Diversity mode, the signals from two transmitters from a common audio source are routed to the outputs of 2 receiver channels. In the event of interference or power loss, the audio from the good channel is switched to both outputs to preserve the audio signal. Switching between channels is seamless and inaudible.

When the receiver senses that the signal quality has improved, audio routing is restored without interrupting the audio signal.

Note: WWB6 software offers an option to selectively lock the diversity audio source to a specific transmitter (see Wireless Workbench 6 section).

Best Practices for Frequency Diversity

- Use the same microphone type and model for each transmitter
- Place microphones within close proximity to the source
- Use the gain controls to match the output levels for each receiver channel
- If Audio Summing is active, use a Y-cable (Shure AXT652) to connect the bodypacks to a single audio source to prevent comb filtering

Choosing Diversity Output Routing

The following receiver channel routing output options are available:

- **1 + 2**
- **3 + 4** (quad only)
- **1 + 2 / 3 + 4** (quad only)

To enable Frequency Diversity and select a routing option:

DEVICE UTILITIES > FREQ DIVERSITY

Use the control wheel to choose a routing option, and then press **ENTER**.

Note: Choose **OFF** to disable Frequency Diversity.

Frequency Diversity and Encryption

Enabling Encryption while in Frequency Diversity mode provides an additional layer of protection by only passing audio from the most recently synced encrypted transmitter for each receiver channel.

Audio Summing

Audio summing allows the dual and quad receivers to function as a 2 or 4 channel mixer, respectively. All XLR outputs of the selected channels provide the summed audio. For example, when **1 + 2** is selected (see diagram), the XLR outputs of channels 1 and 2 supply the summed audio of the two channels.

Choosing an Audio Summing Mode

The following Audio Summing mode options are available:

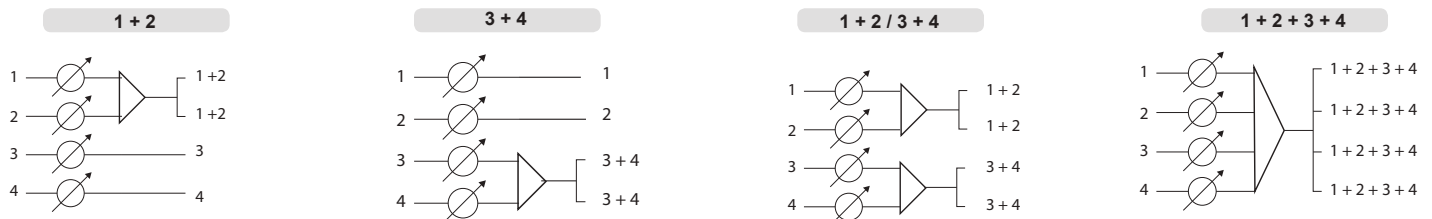

To select an Audio Summing mode:

1. Menu: **DEVICE UTILITIES > AUDIO SUMMING**
2. Use the control wheel to select an option, and then press **Enter**.

Note: When set to **OFF**, Audio Summing is disabled.

Adjusting Gain for Summed Outputs

Use the gain controls for each channel to create the overall mix balance. The front panel LEDs indicate the audio level for each channel. If an overload occurs, the red LEDs will illuminate indicating that the internal limiter is active and the display will show an overload message. To correct, adjust the overall gain balance.

Firmware

Firmware is embedded software in each component that controls functionality. Periodically, new versions of firmware are developed to incorporate additional features and enhancements. To take advantage of design improvements, new versions of the firmware can be uploaded and installed using the Firmware Update Manager tool available in Shure's Wireless Workbench® 6 (WWB6) software. Software is available for download from <http://www.shure.com/wwb>.

Firmware Versioning

When updating receiver firmware, update transmitters to the same firmware version to ensure consistent operation.

The firmware of all ULX-D devices has the form of MAJOR.MINOR.PATCH (e.g., 1.2.14). At a minimum, all ULX-D devices on the network (including transmitters), must have the same MAJOR and MINOR firmware version numbers (e.g., 1.2.x).

Updating the Receiver

CAUTION! Ensure that receiver power and network connections are maintained during a firmware update. Do not turn off the receiver until the update is complete.

Once the download is complete, the receiver automatically begins the firmware update, which overwrites the existing firmware.

1. From Shure Wireless Workbench software, open the Firmware Update Manager: **Tools > Firmware Update Manager**.
2. Click **Check Now** to view new versions available for download.
3. Select the updates and click **download**.
4. Connect the receiver and computer to the same network.
5. Download the latest firmware to the receiver.

Updating the Transmitter

1. To upload the firmware to the transmitter, go to **DEVICE UTILITIES > TX FW UPDATE** on the receiver.
2. Place the transmitter on its side and align the IR ports.
3. Press **ENTER** on the receiver to begin the download to the transmitter. IR ports must be aligned for the entire download, which can take 50 seconds or longer.

Transmitter Presets

Use the **TX SYNC SETUP** menu to configure transmitter settings on the receiver to transfer to the transmitter during a sync. Each parameter has the default value **KEEP**, which leaves that setting unaffected by a sync.

Feature	Setting
BP PAD	0 dB, -12 dB
LOCK	Power, Menu, All, None
RF POWER	10mW=Nm, 1mW=Lo, 20mW=Hi
BATT	Alkaline, NiMH, Lithium
BP OFFSET	0 dB to +21 dB (in 3 dB increments)
HH OFFSET	0 dB to +21 dB (in 3 dB increments)
Cust. Group	OFF, ON

Note: When **Cust. Group** is set to **ON**, it may take up to 30 seconds to complete an IR sync. Select **OFF** if Custom Groups are not in use for faster IR sync.

Creating a System Preset

System Presets allow a current receiver setup to be saved and restored. Presets store all receiver settings to provide a quick way to configure a receiver or switch between several different setups. Up to 4 presets can be stored in receiver memory.

To save the current receiver setup as a new preset: **DEVICE UTILITIES > SYSTEM RESET > SAVE > CREATE NEW PRESET**

Use the control wheel to name the preset, and then press Enter to save.

To recall a saved preset: **DEVICE UTILITIES > SYSTEM RESET > RESTORE**

Use the control wheel to select the preset name, and then press Enter.

Locking Controls and Settings

Use the **LOCK** feature to prevent accidental or unauthorized changes to the hardware.

Receiver

Menu path: **DEVICE UTILITIES > LOCK**

Use the control wheel to select and lock any of the following receiver functions.

- **MENU:** All menu paths are inaccessible
- **GAIN:** Gain adjustment is locked
- **POWER:** Power switch is disabled
- **SCN/SYC:** Cannot perform a Scan and Sync

Tip: To unlock, press the **EXIT** button, turn the control wheel to select **UNLOCKED**, and then press **ENTER** to save.

Transmitter

Menu path: **UTILITY > LOCK**

Use the transmitter controls to select and lock any of the following transmitter functions.

- **MENU LOCK:** All menu paths are inaccessible.
- **POWER LOCK:** Power switch is disabled

Quick-Lock Option: To turn on the transmitter with its power and menu navigation buttons locked, press and hold the **▲** button during power-on until the locked message is displayed.

Tip: To unlock the **MENU LOCK**, press the **ENTER** button 4 times to pass through the following screens: **UTILITY > LOCK > MENU UNLOCK**

To unlock the **POWER LOCK**, set the power switch to the **off** position, then press and hold the **▲** button while resetting the power switch to the **on** position.

Encryption

ULX-D features Advanced Encryption Standard (AES-256) to ensure that only the receiver that is keyed to the transmitter can monitor the audio content.

Note: When enabled, encryption is applied to all receiver channels. Encryption does not affect Dante audio signals, audio quality, or channel spacing.

1. Enable encryption on the receiver: **DEVICE UTILITIES > ENCRYPTION**.
The encryption symbol illuminates and the LCD displays **SYNC NOW FOR ENCRYPTION**.
2. Sync the transmitter to the receiver. The encryption symbol displays on the transmitter.

Note: Any change to the encryption status on the receiver such as enabling/disabling encryption or requesting a new encryption key, requires a sync to send the settings to the transmitter. **ENCRYPTION MISMATCH** warning will display on the receiver LCD panel if the transmitter and receiver do not share the same encryption key.

Custom Groups

Use this feature to create and export up to 6 groups of manually selected frequencies to networked receivers prior to a group scan to simplify system set up.

Tip: Use Wireless Workbench or Wireless Frequency Finder to select the best compatible frequencies. See www.shure.com for more information.

To create a custom group: **DEVICE UTILITIES > ADVANCED RF > CUSTOM GROUPS > SETUP**

Use the control wheel to choose group, channel and frequency values. Press **ENTER** to save.

Prior to performing a group scan, export a custom group to networked receivers:

1. Go to **DEVICE UTILITIES > ADVANCED RF > CUSTOM GROUPS > EXPORT**
2. Press the flashing **ENTER** button to export all custom groups to all receivers on the network.

Note: Use the **CLEAR ALL** option to remove all custom group settings.

System Reset

System Reset clears the current receiver settings and restores the factory default settings.

To restore factory default settings:

1. Go to **DEVICE UTILITIES > SYSTEM RESET > RESTORE**.
2. Scroll to the **DEFAULT SETTINGS** option and press **ENTER**.
3. Press the flashing **ENTER** button to return the receiver to the default settings.

RF Cascade Ports

The receiver has 2 RF cascade ports on the rear panel to share the signal from the antennas with 1 additional receiver.

Use a shielded coaxial cable to connect the RF cascade ports from the first receiver to the antenna inputs of the second receiver.

Important! The frequency band must be the same for both receivers.

Antenna Bias

Antenna ports A and B provide a DC bias to power active antennas. Set the DC power to off when using passive (non-powered) antennas.

To turn bias off: **DEVICE UTILITIES > ADVANCED RF > ANTENNA BIAS > OFF**

Receiver Menu Descriptions

Channel Home Screen

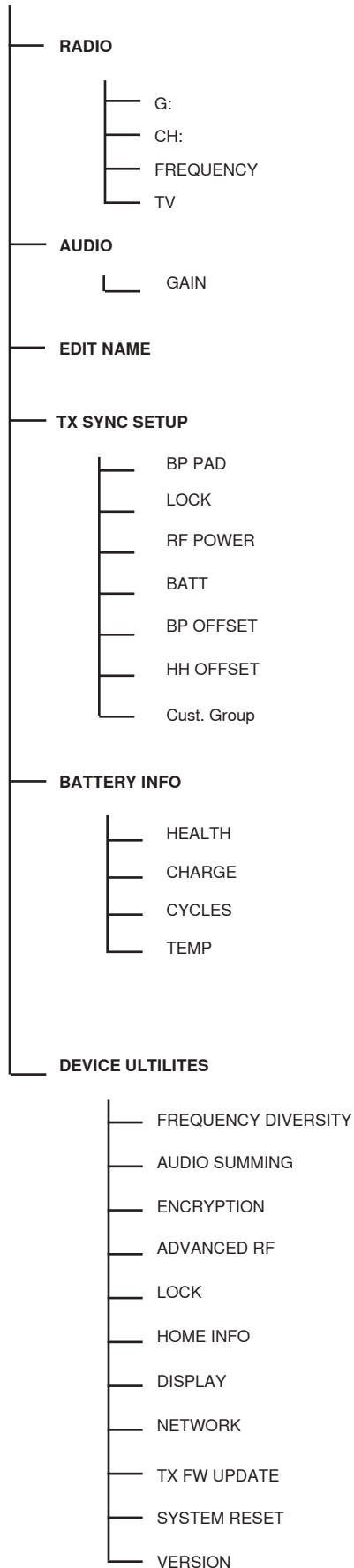

RADIO

Displays Group, Channel, Frequency, and TV information. Use the control wheel to edit values

G:
Group for the selected frequency

CH:
Channel for the selected frequency

FREQUENCY
Selected frequency (MHz)

TV:
Displays the TV channel for the selected frequency

AUDIO

GAIN
Use the control wheel or gain buttons to adjust the channel gain from -18 to 42 dB, in 1 dB increments.

EDIT NAME

Use the control wheel to assign and edit the selected receiver channel name.

TX SYNC SETUP

BP PAD
Sets the audio input attenuation options: **KEEP**, 0, -12.

LOCK
Sets the lock options: **KEEP**, Power, Menu, All, None

RF POWER
Sets the transmitter RF power level: **KEEP**, 10mW=Nm, 1mW=Lo, 20mW=Hi.

BATT
Sets the transmitter battery type to ensure accurate metering: **KEEP**, Alkaline, NiMH, Lithium

BP OFFSET
Adjustable gain to compensate for signal level difference between transmitters: **KEEP**, 0 to 21 dB in 3 dB increments

HH OFFSET
Adjustable gain to compensate for signal level difference between transmitters: **KEEP**, 0 to 21 dB in 3 dB increments

Cust. Group
Create Custom Groups of up to 6 frequencies and export to networked receivers

BATTERY INFO

HEALTH
Percentage of charge capacity compared to a new battery

CHARGE
Percentage of charge capacity

CYCLES
Number of charge cycles logged by the battery

TEMP
Battery temperature: °C/°F

DEVICE UTILITIES

FREQ DIVERSITY

- OFF (default)
- 1 + 2
- 3 + 4 (quad only)
- 1 + 2 / 3 + 4 (quad only)

AUDIO SUMMING

- OFF (default)
- 1 + 2
- 3 + 4 (quad only)
- 1 + 2 / 3 + 4 (quad only)
- 1 + 2 + 3 + 4 (quad only)

ENCRYPTION

Set encryption: ON/OFF

ADVANCED RF

- HIGH DENSITY: ON/OFF
- CUSTOM GROUPS: SETUP/EXPORT/CLEAR
- ANTENNA BIAS: ON/OFF
- SWITCH BAND (Japan AB band only)

LOCK

- MENU: LOCKED/UNLOCKED
- GAIN: LOCKED/UNLOCKED
- POWER: LOCKED/UNLOCKED
- SCN/SYC: LOCKED/UNLOCKED

HOME INFO

Select screen options for Home Menu.

DISPLAY

- CONTRAST
- BRIGHTNESS: LOW/MEDIUM/HIGH

NETWORK

- CONFIGURATION: SWITCHED/REDUNDANT AUDIO/SPLIT
- SHURE CONTROL: DEVICE ID, Network Mode, Set IP and Subnet values for Ethernet network
- DANTE: DANTE DEVICE ID, AUDIO & CNTRL, REDUNDANT AUDIO, Set IP and Subnet values for Dante™ network

Note: Additional information can be accessed from the selected networking option.

TX FW UPDATE

IR DOWNLOAD, Tx Firmware Version

SYSTEM RESET

- RESTORE: Default Settings, Presets
- SAVE: Create New Preset
- DELETE: Delete Preset

VERSION

- Model
- Band
- S/N (serial number)
- Ver
- Mcu
- FPGA
- Boot

Networking ULX-D Receivers

ULX-D Dual and Quad receivers feature a Dante dual-port network interface. Dante technology provides an integrated solution to distribute digital audio, manage control signals, and carry Shure Control (WWB and AMX/Crestron) signals. Dante uses standard IP over Ethernet and safely coexists on the same network as IT and control data. Selectable Dante networking modes route port signals for flexible network set up.

Network Control Software

The ULX-D receivers can be controlled by Shure Control (WWB6) for remote management and monitoring and the Dante Controller to manage digital audio routing. Signals for AMX and Crestron controllers are carried on the same network as Shure Control.

Shure Control

Wireless Workbench 6 (WWB6) software provides comprehensive control for wireless audio systems. Wireless Workbench enables live remote adjustments to networked receivers for real-time changes to gain, frequency, RF power, and control locks. A familiar channel strip interface displays audio meters, transmitter parameters, frequency settings and network status.

Wireless Workbench 6 is available for Windows or Mac and can be downloaded at: www.shure.com/wwb

Dante

The Dante controller is a free software program created by Audinate™ to configure and manage a network of Dante enabled devices. Use the controller to create audio routes between networked components and to monitor the status of online devices.

Visit www.audinate.com for download and installation instructions.

IP Address Configuration

An IP address must be assigned to each device in the network to ensure communication and control between components. Valid IP addresses can be assigned automatically using a DHCP server or manually from a list of valid IP addresses. If using Dante audio, a separate Dante IP address must also be assigned to the receiver.

Automatic IP Addressing

1. If using a DHCP capable Ethernet switch, set the DHCP switch to ON.
2. Set the IP Mode to Automatic for all receivers: **DEVICE UTILITIES > NETWORK > SHURE CONTROL > NETWORK**
3. Use the control wheel to set the mode to **Automatic**, press **ENTER** to save.

Note: Use only one DHCP server per network.

Manual IP Addressing

1. Connect the receivers to an Ethernet switch.
2. Set the IP Mode to Manual for all devices: **DEVICE UTILITIES > NETWORK > SHURE CONTROL > NETWORK**
3. Use the control wheel to set the mode to **Manual**.
4. Set valid IP addresses and subnet values for all devices, press **ENTER** to save.

Dante IP Addressing

IP addresses for a Dante network can be assigned automatically using a DHCP server or manually from a list of valid IP addresses.

To select the Dante IP addressing mode (Automatic or Manual): **DEVICE UTILITIES > NETWORK > DANTE > AUDIO & CNTRL**

Use the control wheel to select the mode, and then press **ENTER** to save.

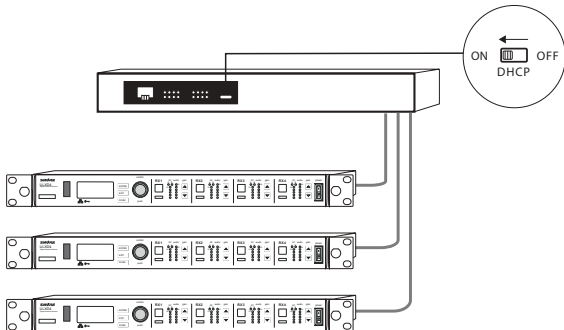

Networking Acronyms

DHCP: Dynamic Host Configuration Protocol
LAN: Local Area Network
MCU: Micro Controller Unit
RJ45: Ethernet Connection
RX: Receiver
TX: Transmitter
WWB6: Wireless Workbench 6 Software
VLAN: Virtual Local Area Network
MAC: Machine Access Code

Overview of Dante Network Modes

The Dante network interface has two ports (Primary and Secondary) to provide flexible routing and configuration options for network signals. Three selectable Dante network modes are available to control signal routing from the receiver ports to the Dante network.

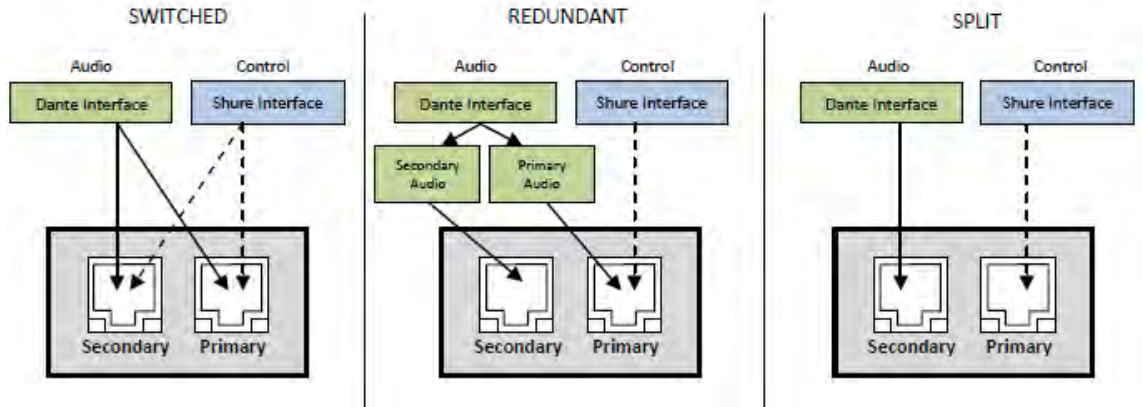

Network Mode	Port Function and Signals		Application
	Secondary	Primary	
SWITCHED	Shure Control Dante Audio and Control	Shure Control Dante Audio and Control	For single network Installations of star or daisy-chained networks.
REDUNDANT AUDIO	Dante Redundant Audio	Shure Control Dante Audio and Control	Primary and Secondary ports are configured as 2 separate networks. The Secondary port carries a backup copy of the Primary digital audio signal.
SPLIT	Dante Audio and Control	Shure Control	Primary and Secondary ports are configured as 2 separate networks to provide isolation between control signals and audio signals.

Setting the Dante Networking Mode

Select a Dante mode to configure network signal routing on the Primary and Secondary ports. Set all receivers on the network to the same mode.

Note: Remove network connections from the receiver before changing the mode.

1. From the receiver menu: **DEVICE UTILITIES > NETWORK > CONFIGURATION**
2. Use the control wheel to select a mode (**SWITCHED**, **REDUNDANT AUDIO**, **SPLIT**)
3. Press **ENTER** to save.
4. Cycle receiver power to enable the mode change.

CONFIGURATION
SWITCHED (default)

Network Connection and Configuration Examples

Note: Use shielded Cat5e cable for network connections to ensure reliable performance.

Switched Mode

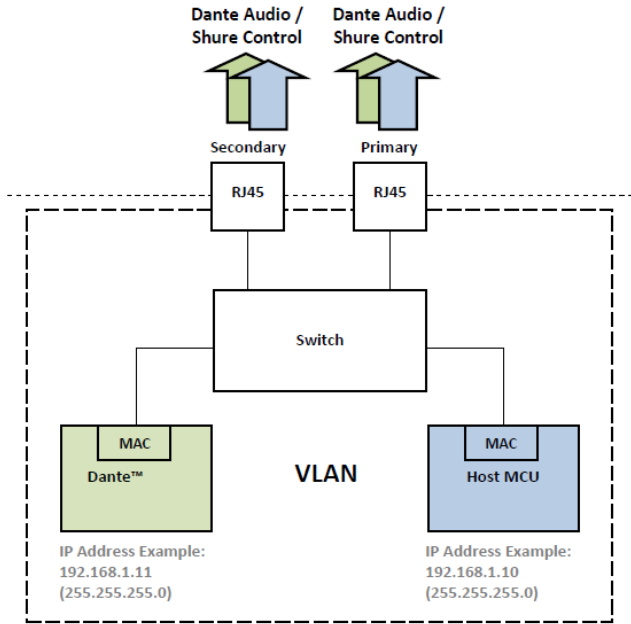

Switched mode is typically used for single network installations of star or daisy-chained networks. Switched mode is recommended for installations that don't require Dante audio.

Network Characteristics:

- Dante Audio and Shure Control are present on both the Primary and Secondary ports
- The Dante IP address and the Shure Control IP address must be on the same subnet. The computer running WWB6 must also be on this subnet.

Network Example (Dante Audio + WWB6)

- 1 Computer**
Connect the computer running the Dante controller and WWB6 to the Primary port.
- 2 DHCP Server**
Can be configured with or without a DHCP server. Do not route audio through the server.
- 3 Gigabit Ethernet Switch**
 - Do not connect both network ports to the same Ethernet switch
 - Use a star network topology to minimize audio latency
- 4 Receiver Connection**
Connect receivers to the Primary port
- 5 Dante Receiver**
Connect Dante receivers (mixers, recorders, amplifiers) to the Primary port.

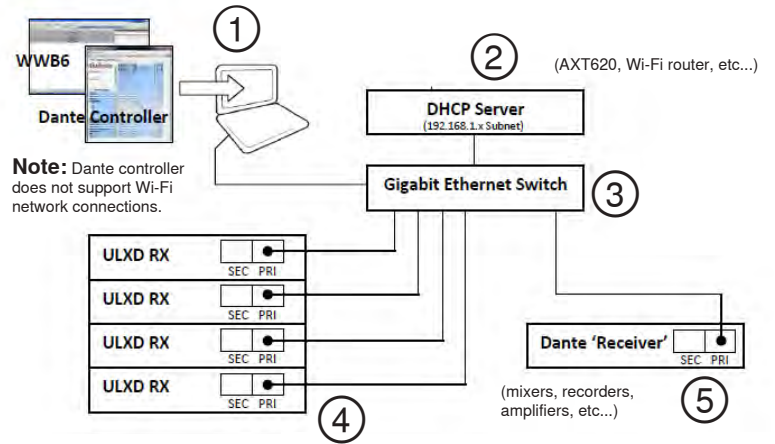

Network Example (WWB6 Only)

- 1 Computer**
Connect the computer running WWB6 to the Primary port.
- 2 DHCP Server**
Can be configured with or without a DHCP server.
- 3 Receiver Connection**
Connect receivers to the Primary port

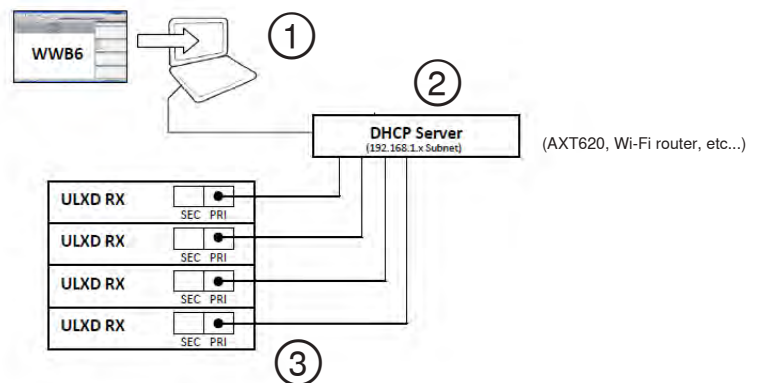

Redundant Audio Mode

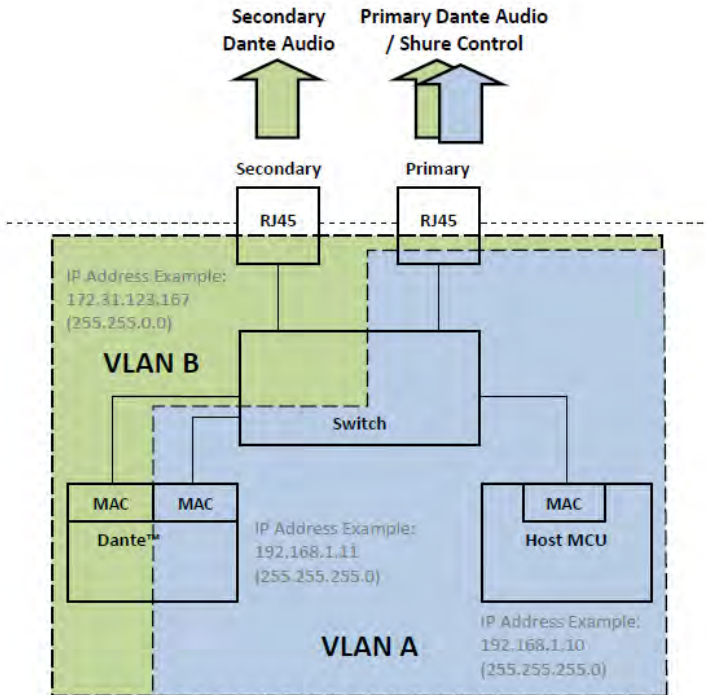

Use Redundant mode to carry a backup copy of the Dante audio on the Secondary network in case the audio on the primary network is interrupted.

Network Characteristics:

- Dante Primary Audio and Shure Control are present on the Primary port
- Backup Dante audio is present on the Secondary port
- The Primary Dante IP address and the Shure Control IP address must be on the same subnet. The computer running WWB6 must also be on this subnet.
- The Secondary Dante IP Address must be set to a different subnet

Note: Devices connected to the Redundant network must be compatible with Redundant audio.

Network Example

1 Computer

Connect the computer running the Dante controller and WWB6 to the Primary port.

2 DHCP Server

Can be configured with or without a DHCP server. Do not route audio through the server.

3 Gigabit Ethernet Switches

- Use dedicated switches for the Primary and Secondary networks
- Do not connect both network ports to the same Ethernet switch
- Use a star network topology to minimize audio latency

4 Receiver Connection

Connect Primary and Secondary ports to dedicated switches.

Note: The Secondary port only supports manual IP or automatic Link-Local configuration. The Link-Local Dante Secondary address subnet is preset to 172.31.x.x (255.255.0.0)

5 Dante Receiver

Connect Dante receivers (mixers, recorders, amplifiers) to the Primary or Secondary ports.

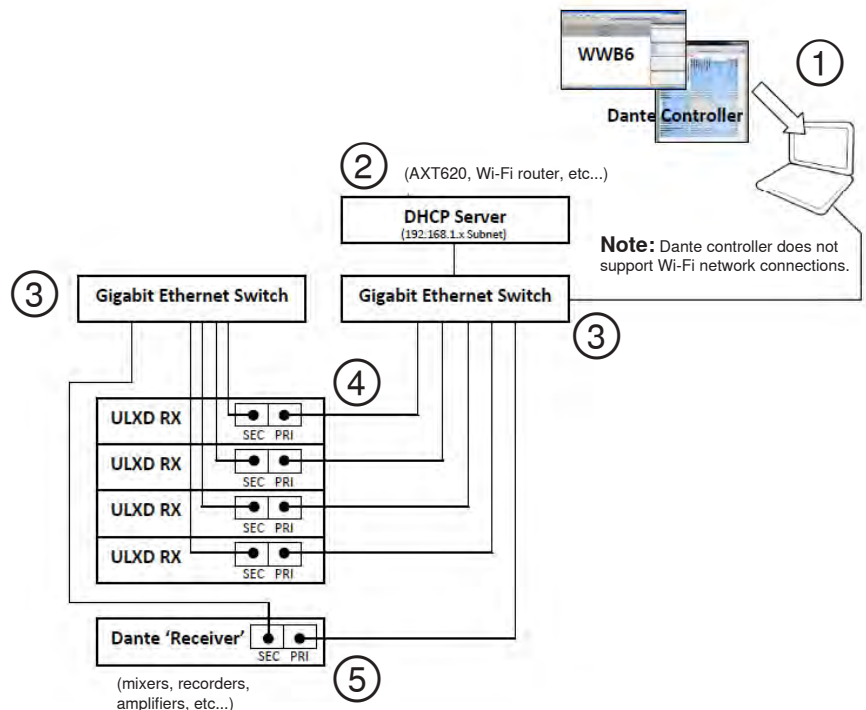

Split Mode

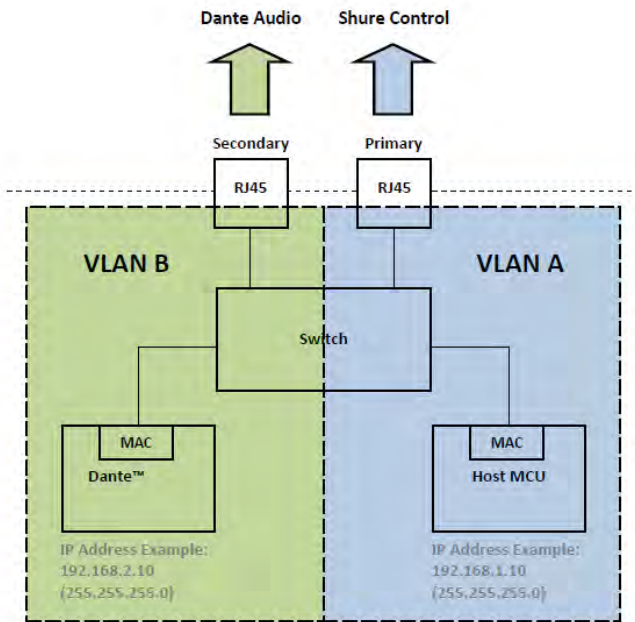

Use Split Mode to isolate control signals from audio signals by placing them on two separate networks.

Network Characteristics:

- Shure Control is present on the Primary port
- Dante Audio is present on the Secondary port
- The IP addresses for Dante and Shure Control must be on different subnets

Network Example

① Computer (Dante Controller)

Connect the computer running the Dante controller to the Secondary port.

② DHCP Server (Secondary Network)

Can be configured with or without a DHCP server. Do not route audio through the server.

③ Gigabit Ethernet Switch (Secondary Network)

- Use dedicated switches for the Primary and Secondary networks
- Do not connect both network ports to the same Ethernet switch
- Use a star network topology to minimize audio latency

④ Receiver Connections (Dante Audio)

Connect the Secondary ports to the Secondary network switch.

⑤ Computer (Shure Control)

Connect the computer running the Shure Control to the Primary port.

⑥ DHCP Server (Primary Network)

Can be configured with or without a DHCP server. Do not route audio through the server.

⑦ Gigabit Ethernet Switch (Primary Network)

- Use dedicated switches for the Primary and Secondary networks
- Do not connect both network ports to the same Ethernet switch
- Use a star network topology to minimize audio latency

⑧ Receiver Connections (Shure Control)

Connect the Primary ports to the Primary network switch.

⑨ Dante Receiver

Connect Dante receivers (mixers, recorders, amplifiers) to the Primary port.

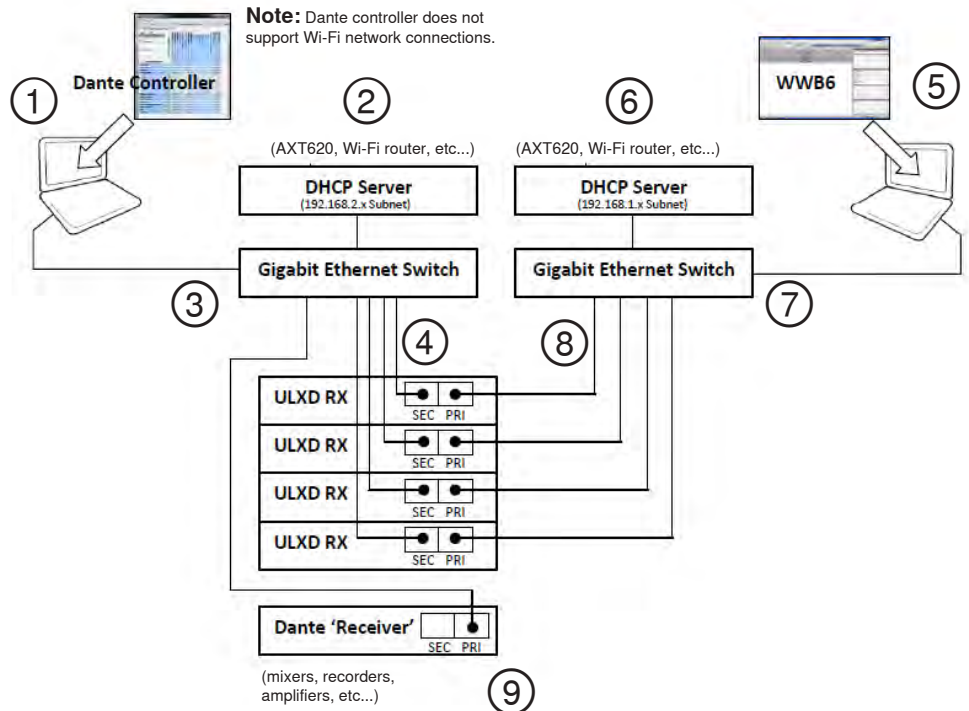

Assigning Network Device IDs for Shure Control and Dante Control

When using the receiver in a network with Shure Control (WWB6) and a Dante Controller, two Device IDs are required: one for Shure Control and one for Dante Control. Device IDs are used to identify devices on the network and for creating Dante digital audio routes.

Best Practices

Using the following best practices will help to organize network setup and ease troubleshooting.

- For consistency, convenience, and easy troubleshooting, use the same device ID for both WWB6 (Shure Control) and for the Dante network.
- The Dante network requires unique Dante device IDs to prevent a loss of audio signal routing. Any duplicate IDs on the network will be tagged with a number such as -1, -2, -3, etc.... and must be changed to a unique value.
- WWB6 (Shure Control) does not require unique device IDs and duplicates do not affect the Dante network; however, a best practice is to use unique device IDs.

Setting the Shure Control Device ID

1. Launch WWB6.
2. Open the Inventory View.
3. Click on the Device ID to enable editing.

Tip: Click on the device icon next to the channel name to identify the receiver using the Flash function.

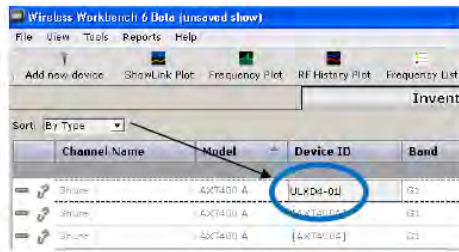

Optionally, the Shure Control Device ID can be entered from the receiver front panel:

1. From the receiver menu: **DEVICE UTILITIES > NETWORK > SHURE CONTROL > Dev. ID**
2. Use the control wheel to edit the ID.
3. Press **ENTER** to save.

Setting the Dante Device ID

The Dante ID can be set from the ULXD receiver menu or from the Dante controller.

Note: Changing the Dante ID will cause a loss of audio signal. After an ID has been changed, use the Dante controller to restore audio route subscriptions using the new ID.

From the receiver menu:

1. **DEVICE UTILITIES > NETWORK > DANTE > Dev. ID**
2. Use the control wheel to enter a unique ID.
3. Press **ENTER** to save.

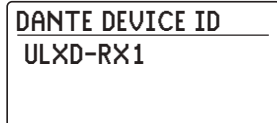

From the Dante controller:

1. Open the **Device View** and select the receiver from the pulldown menu.
2. Click on the **Device Config** tab.
3. Enter the ID in the **Rename Device** box and press **ENTER**.

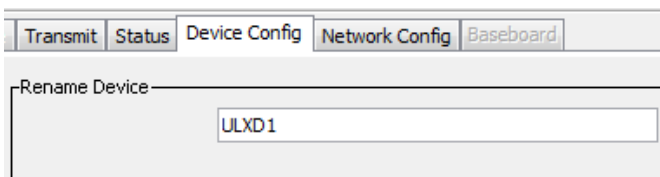

Viewing Dante Device IDs in the Dante Controller

Dante device IDs are displayed in the **Network View** window in the Dante Controller.

1. Launch the Dante controller and open the **Network View** window.
2. Verify that the Dante device IDs match the IDs entered in the receiver.

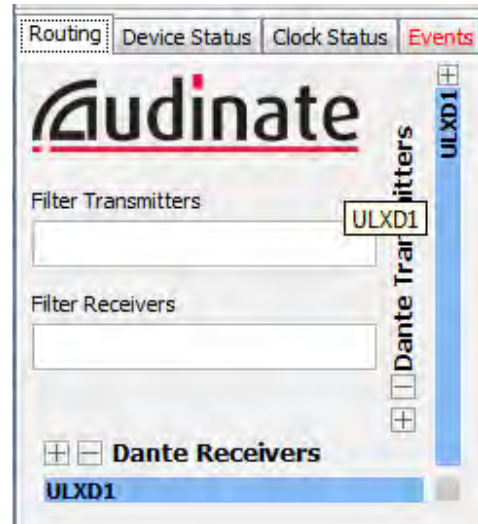

Identify Device Feature

The Dante controller's Identify Device feature flashes the front panel LEDs of a selected receiver to provide identification when multiple receivers are in use.

Open the **Device View** in the Dante controller and click on the identify icon (eye). The front panel LEDs of the selected receiver will respond by flashing.



Configuring Audio Routes with the Dante Controller

Devices that appear in the Dante controller are categorized as "Transmitters" and "Receivers"

In order for audio to flow in the network, audio routes (subscriptions) must be configured between transmitters and receivers.

Note: ULX-D receivers will appear in the Dante controller as a Transmitter. Devices that have both inputs and outputs commonly appear as both transmitters and receivers.

Dante Transmitters

Devices that send or add audio into the network such as:

- Receiver Outputs
- Amplifier Outputs
- Mixer Outputs
- Signal Processor Outputs
- Recorder Playback Outputs



Dante Receivers

Devices that receive audio from the network such as:

- Amplifier Inputs
- Mixer Inputs
- Signal Processor Inputs
- Recorder Inputs

Forming an Audio Route

Launch the Dante Controller and click on the intersection point between components to form an audio route. The audio route is also referred to as a Subscription.

1. Find the intersection between the transmitter and receiver channels.
2. Click on the  where the components meet.
3. A green checkmark  indicates that the audio route has been established.
4. Check the audio to verify that the audio route has been formed.

For additional information about the Dante controller, visit www.audinate.com.

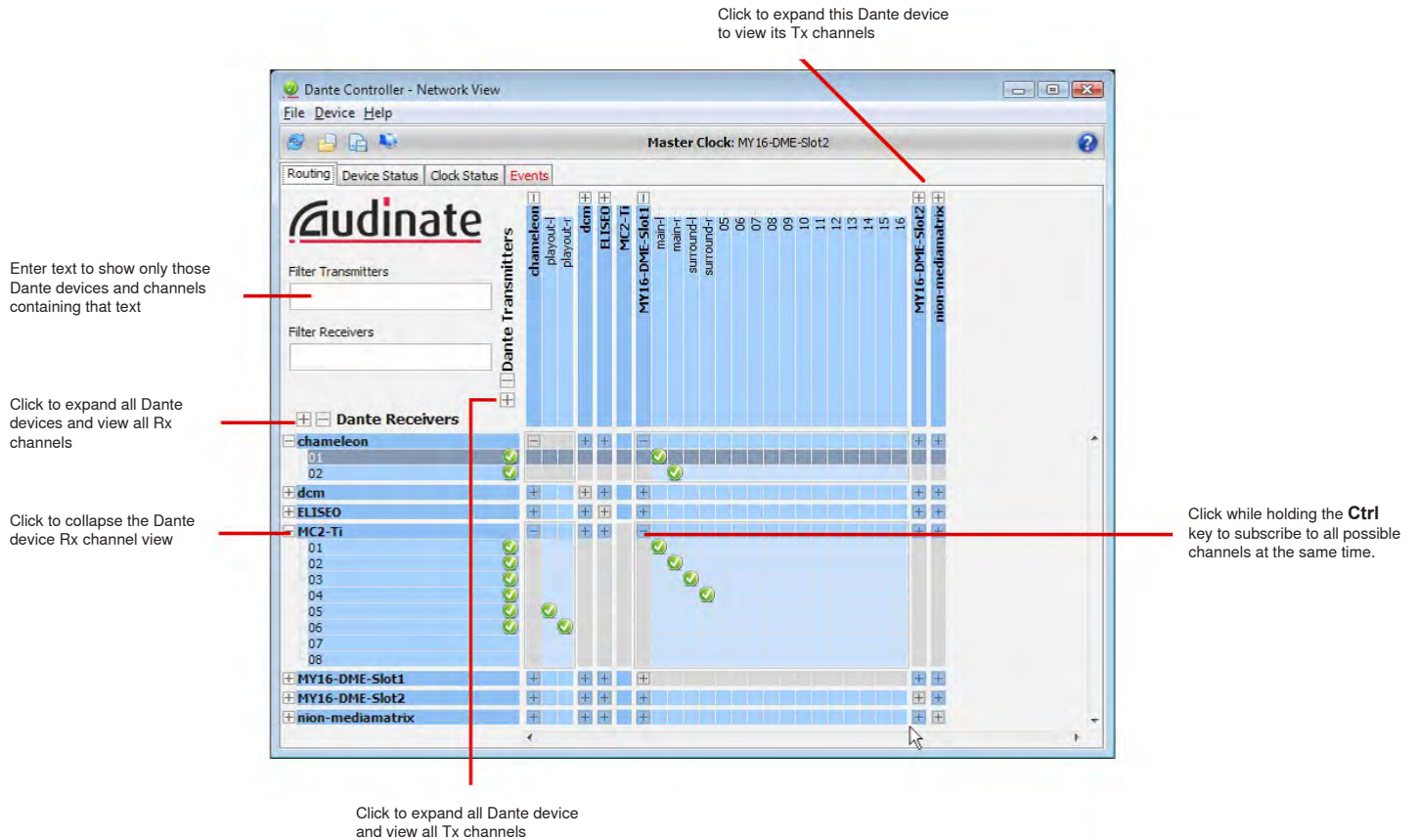

Restoring Dante Factory Settings

The receiver and the Dante network card can be reset to restore factory Dante settings. Performing a reset is helpful for clearing existing data before setting up a system.

Caution! Performing a reset on either the Dante network card or on the ULX-D receiver will interrupt the Dante audio.

Tip: Prior to performing a factory reset, note the current Dante network mode and IP settings. After a reset, the Dante network mode reverts to **SWITCHED**, and the IP address mode revert to **AUTO**.

Restoring Receiver and Dante Card Factory Settings

Performing a reset from the receiver restores the factory settings and configures the Shure Control and Dante IP address mode to AUTO.

1. From the receiver menu: **DEVICE UTILITIES > SYSTEM RESET > RESTORE DEFAULT SETTINGS**
2. Press **ENTER** to complete the reset.

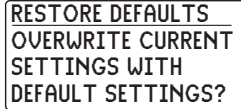
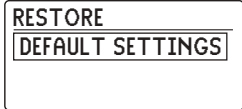

Restoring the Dante Network Card Factory Settings

The **Factory Reset** option within the Dante controller restores the Dante card to the factory settings and configures the Dante IP address mode to AUTO.

1. From the Dante controller, select a receiver and open the **Network Config** tab.
2. Click on **Factory Reset**.
3. Allow the Dante controller to refresh before making any additional changes.



Connecting to an AMX or Crestron System

The ULX-D receiver connects to an AMX or Crestron control system via the Ethernet, using on the same cables used to carry Shure Control (WWB6). Use only one controller per system to avoid messaging conflicts.

- Connection: Ethernet (TCP/IP; ULX-D receiver is the client)
- Port: 2202

For a comprehensive list of ULX-D command strings, visit: http://shure.custhelp.com/app/answers/detail/a_id/4976

Network Troubleshooting

- Use only one DHCP server per network
- All devices must share the same subnet mask
- All receivers must have the same level of firmware revision installed
- Look for the illuminated network icon on the front panel of each device:

If the icon is not illuminated, check the cable connection and the LEDs on the network jack.

If the LEDs are not on and the cable is plugged in, replace the cable and recheck the LEDs and network icon.

To check connectivity of WWB6 to the network:

1. Start WWB6 software and use Inventory view to see devices connected to the network.
2. If not, find the IP address from one of the devices on the network (such as a ULX-D receiver) and see if you can ping it from the computer running WWB6.
3. From a WINDOWS/MAC command prompt, type 'ping IPADDRESS' of the device (e.g. "ping 192.168.1.100").
4. If the ping returns success (no packet loss), then the computer can see the device on the network. If the ping returns failure (100% packet loss), then check the IP address of the computer to ensure it's on the same subnet.
5. If the pings are successful and the devices still do not show up in the WWB6 inventory, check to ensure all firewalls are either disabled or allow the WWB network traffic to pass to the application. Check that firewall settings are not blocking network access.

Managing the ULXD Receiver with Wireless Workbench 6

Adding a computer running Wireless Workbench® 6 to the network allows for remote control and monitoring of the receiver.

Visit: www.shure.com/wwb to download Wireless Workbench 6 software.

Viewing the Receiver in WWB6 Inventory

Click on the Inventory tab to view the receiver channels. Double-click on parameters to enable editing.

Tip: Clicking on the receiver icon next to the Model flashes the front panel LEDs for remote identification.

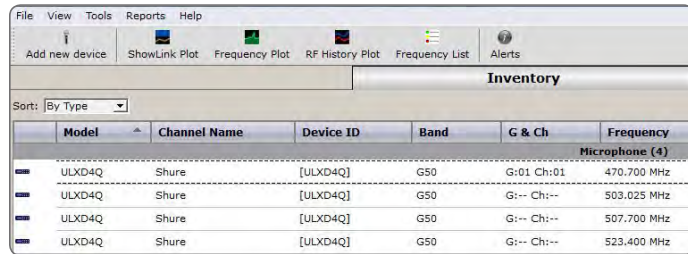

Model	Channel Name	Device ID	Band	G & Ch	Frequency
ULXD4Q	Shure	[ULXD4Q]	G50	G:01 Ch:01	470.700 MHz
ULXD4Q	Shure	[ULXD4Q]	G50	G:-- Ch:--	503.025 MHz
ULXD4Q	Shure	[ULXD4Q]	G50	G:-- Ch:--	507.700 MHz
ULXD4Q	Shure	[ULXD4Q]	G50	G:-- Ch:--	523.400 MHz

Managing and Monitoring Receiver Settings

Manage and monitor receiver settings by opening the Monitor tab in Wireless Workbench. Click on the **Settings** button to show or hide the full Properties window.

1. Click on the Monitor tab to view the Device Chooser.
2. From the Device Chooser, click on a channel to select.
3. Click on Properties to open the Properties window.

① RF and Audio Meters

Displays: current levels, band, TV, and TX Overload

② Transmitter Settings

Displays: RF Power, Tx Type, Tx Offset, Tx Lock

③ Frequency Settings

Use drop-down to edit value

④ Encryption Icon

Illuminates when Encryption is enabled

⑤ Receiver Output Mute

Click on the mute button to enable mute

⑥ Receiver Gain Setting

Use drop-down to edit value

⑦ Custom Groups

Click to enter custom group settings

⑧ IR Presets

Click to configure transmitter IR presets

⑨ Utilities Tab

Accesses Utility settings

⑩ Network Tab

Set network mode, view: IP address, Subnet, MAC, Firmware version

⑪ Advanced RF Settings

Enable High Density mode or Antenna Bias

⑫ Encryption

Enable/Disable Encryption

⑬ Frequency Diversity Mode

Enable and Select Frequency Diversity mode

⑭ Audio Summing

Enable and Select Audio Summing mode

⑮ Locks

Lock/Unlock: Menu, Gain, Power, Scan/Sync



Locking the Audio Source in Frequency Diversity Mode

WWB6 software offers an option to selectively lock the Frequency Diversity audio source to a specific transmitter.

Lock the audio source to select the best audio if a problem develops with one of the channels.

1. Open the monitoring tab.
 2. Under **FD Audio Source**, click on "Lock to" option to select a transmitter as the audio source.
- To restore Frequency Diversity switching, click on the **Auto Switch** option.

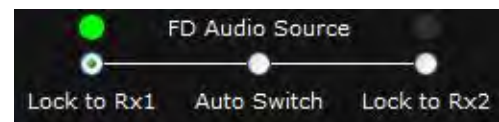

Troubleshooting

Issue	See Solution...
No Sound	Power, Cables, Radio Frequency, or Encryption Mismatch
Faint sound or distortion	Gain
Lack of range, unwanted noise bursts, or dropouts	RF
Cannot turn transmitter off or change frequency settings, or can't program receiver	Interface locks
Encryption Mismatch message	Encryption Mismatch
Firmware Mismatch message	Firmware Mismatch
Antenna Fault message	RF

Power

Make sure that the receiver and transmitter are receiving sufficient voltage. Check the battery indicators and replace the transmitter batteries if necessary.

Gain

Adjust the system gain on the front of the receiver. Ensure the output level (XLR output only) on the back of the receiver corresponds to the input of the mixing console, amplifier, or DSP.

Cables

Check that all cables and connectors are working correctly.

Interface Locks

The transmitter and the receiver can be locked to prevent accidental or unauthorized changes. A locked feature or button will produce the **Locked** screen on the LCD panel.

Encryption Mismatch

Re-sync all receivers and transmitters after enabling or disabling encryption.

Firmware Mismatch

Paired transmitters and receivers must have the same firmware version installed to ensure consistent operation. See **Firmware** topic for firmware update procedure.

Radio Frequency (RF)

RF LEDs

If neither blue **RF Diversity** LED is illuminated, then the receiver is not detecting the presence of a transmitter.

The amber **RF Signal Strength** LEDs indicate the amount of RF power being received. This signal could be from the transmitter, **or it could be from an interfering source, such as a television broadcast**. If more than one or two of the amber **RF** LEDs are still illuminated while the transmitter is off, then that channel has too much interference, and you should try a different channel.

The red **RF** LED indicates RF overload. This will usually not cause a problem unless you are using more than one system at the same time, in which case, it can cause interference **in the other system**.

Compatibility

- Perform a Scan and Sync to ensure the transmitter and receiver are set to the same group and channel.
- Look at the label on the transmitter and receiver to make sure they are in the same band (G50, J50, L50, etc...).

Reducing Interference

- Perform a group or channel scan to find the best open frequency. Perform a sync to transfer the setting to the transmitter.
- For multiple systems, check that all systems are set to channels in the same group (systems in different bands do not need to be set to the same group).
- Maintain a line of sight between transmitter and receiver antennas.
- Move receiver antennas away from metal objects or other sources of RF interference (such as CD players, computers, digital effects, network switches, network cables and Personal Stereo Monitor (PSM) wireless systems).
- Eliminate RF overload (see below).

Increasing Range

If the transmitter is more than 6 to 60 m (20 to 200 ft) from the receiver antenna, you may be able to increase range by doing one of the following:

- Reduce interference (see above).
- Increase transmitter RF power level.
- Use Normal mode instead of High Density mode.
- Use an active directional antenna, antenna distribution system, or other antenna accessory to increase RF range.

Eliminating RF Overload

If you see the red RF LED on a receiver, try the following:

- Reduce the transmitter RF power level
- Move the transmitter further away from the receiver—at least 6 m (20 ft)
- If you are using active antennas, reduce antenna or amplifier gain.
- Use omnidirectional antennas

Antenna Faults

The **Antenna Fault** message indicates a short circuit condition at an antenna port.

- Check antennas and cables for damage
- Ensure that antenna ports are not overloaded
- Check antenna bias voltage setting. Turn off voltage if using passive antennas.

ULX-D Specifications

RF Carrier Frequency Range

470–932 MHz, varies by region (See Frequency Range and Output Power table)

Working Range

100 m (330 ft)

Note: Actual range depends on RF signal absorption, reflection and interference.

RF Tuning Step Size

25 kHz, varies by region

Image Rejection

>70 dB, typical

RF Sensitivity

–98 dBm at 10⁻⁵ BER

Latency

<2.9 ms

Audio Frequency Response

ULXD1	20 – 20 kHz (±1 dB)
ULXD2	Note: Dependent on microphone type

Audio Dynamic Range

A-weighted, typical, System Gain @ +10

XLR Analog Output	>120 dB
Dante Digital Output	130 dB

Total Harmonic Distortion

–12 dBFS input, System Gain @ +10
<0.1%

System Audio Polarity

Positive pressure on microphone diaphragm produces positive voltage on pin 2 (with respect to pin 3 of XLR output) and the tip of the 6.35 mm (1/4-inch) output.

Operating Temperature Range

–18°C (0°F) to 50°C (122°F)

Note: Battery characteristics may limit this range.

Storage Temperature Range

–29°C (–20°F) to 74°C (165°F)

Note: Battery characteristics may limit this range.

ULXD4D & ULXD4Q

Dimensions

44 x 482 x 274 mmH x W x D

Weight

ULXD4D	3.36 kg (7.4 lbs), without antennas
ULXD4Q	3.45 kg (7.6 lbs), without antennas

Housing

steel; Extruded Aluminum

ULXD4 Power Requirements

ULXD4D	100 to 240 V AC, 50-60 Hz, 0.26 A max.
ULXD4Q	100 to 240 V AC, 50-60 Hz, 0.32 A max.

RF Input

Spurious Rejection

>80 dB, typical

Connector Type

BNC

Impedance

50 Ω

Bias Voltage

12 to 13 V DC, 150 mA maximum, per antenna
switchable on/off

Cascade Output

Connector Type

BNC

Note: For connection of one additional receiver in the same band

Configuration

Unbalanced, passive

Impedance

50 Ω

Insertion Loss

0 dB

Audio Output

Gain Adjustment Range

–18 to +42 dB in 1 dB steps (plus Mute setting)

Configuration

XLR	balanced (1=ground, 2=audio +, 3=audio –)
-----	---

Impedance

100 Ω

Full Scale Output

LINE setting	+18 dBV
MIC setting	–12 dBV

Mic/Line Switch

30 dB pad

Phantom Power Protection

Yes

Networking

Network Interface

Dual Port Ethernet 10/100 Mbps, 1Gbps, Dante Digital Audio

Network Addressing Capability

DHCP or Manual IP address

Maximum Cable Length

100 m (328 ft)

ULXD1

Mic Offset Range

0 to 21 dB (in 3 dB steps)

Battery Type

Shure SB900 Rechargeable Li-Ion or LR6 AA batteries 1.5 V

Battery Runtime

@ 10 mW

Shure SB900	>11 hours
alkaline	11 hours

See Battery Runtime Chart

Dimensions

86 mm x 66 mm x 23 mm (3.4 in. x 2.6 in. x 0.9 in.) H x W x D

Weight

142 g (5.0 oz.), without batteries

Housing

Cast aluminum

Audio Input

Connector

4-Pin male mini connector (TA4M), See drawing for details

Configuration

Unbalanced

Impedance

1 M Ω , See drawing for details

Maximum Input Level

1 kHz at 1% THD

Pad Off	8.5 dBV (7.5 Vpp)
Pad On	20.5 dBV (30 Vpp)

Preamplifier Equivalent Input Noise (EIN)

System Gain Setting \geq +20
-120 dBV, A-weighted, typical

RF Output

Connector

SMA

Antenna Type

1/4 wave

Impedance

50 Ω

Occupied Bandwidth

<200 kHz

Modulation Type

Shure proprietary digital

Power

1 mW, 10 mW, 20 mW

See Frequency Range and Output Power table, varies by region

ULXD2

Mic Offset Range

0 to 21 dB (in 3 dB steps)

Battery Type

Shure SB900 Rechargeable Li-Ion or LR6 AA batteries 1.5 V

Battery Runtime

@ 10 mW

Shure SB900	>11 hours
alkaline	11 hours

See Battery Runtime Chart

Dimensions

256 mm x 51 mm (10.1 in. x 2.0 in.) L x Dia.

Weight

340 g (12.0 oz.), without batteries

Housing

Machined aluminum

Audio Input

Configuration

Unbalanced

Maximum Input Level

1 kHz at 1% THD
145 dB SPL (SM58), typical
Note: Dependent on microphone type

RF Output

Antenna Type

Integrated Single Band Helical

Occupied Bandwidth

<200 kHz

Modulation Type

Shure proprietary digital

Power

1 mW, 10 mW, 20 mW

See Frequency Range and Output Power table, varies by region

Battery Runtime

Battery Type	1 mW	10 mW	20 mW
SB900	>11 hours	>11 hours	>7 hours
Alkaline	<11 hours	<11 hours	<5.5 hours
NiMH	<11 hours	<11 hours	<8 hours
Li-primary	12.5-18 hours	12.5-18 hours	9.5-12 hours

The values in this table are typical of fresh, high quality batteries. Battery runtime varies depending on the manufacturer and age of the battery.

Tables and Diagrams

TA4M Connector

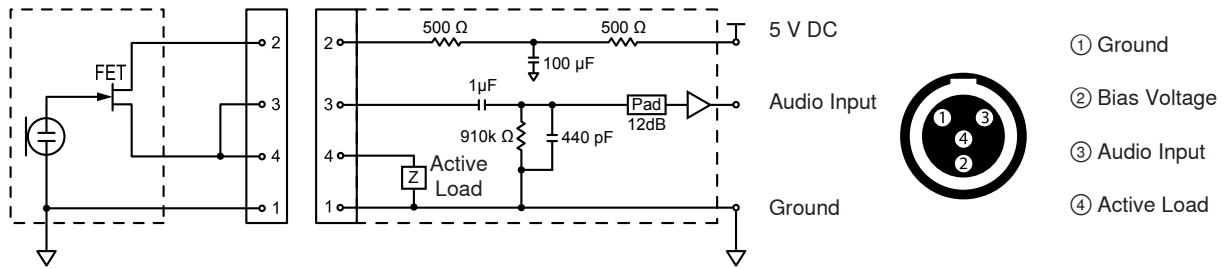

XLR Receiver Output

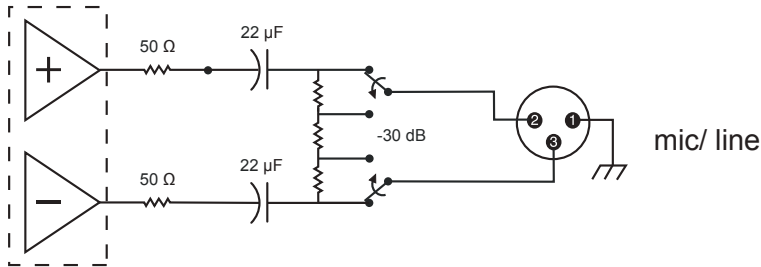

XLR to 1/4 Output

Use the following wiring diagram to convert the XLR output to a 1/4 output.

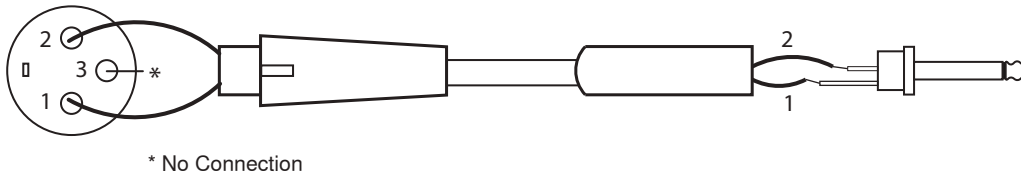

Frequency Range and Transmitter Output Power

Band	Frequency Range (MHz)	Power (mW)
G50	470 to 534	1/10/20
G51	470 to 534	1/10/20
G52	479 to 534	1/10
H51	534 to 598	1/10/20
H52	534 to 565	1/10
J50	572 to 636	1/10/20
K51	606 to 670	1/10
L50	632 to 696	1/10/20
L51	632 to 696	1/10/20

Band	Frequency Range (MHz)	Power (mW)
P51	710 to 782	1/10/20
R51	800 to 810	1/10/20
JB (Tx only)	806 to 810	1/10
AB (Rx and Tx)	770 to 810	"A" band (770.250-805.750): 1/10/20 "B" band (806.125-809.750): 1/10
Q51	794 to 806	1/10/20
X50	925 to 932	1/10

Furnished Accessories

All Systems

Receiver	ULXD4D (Dual Receiver), ULXD4Q (Quad Receiver)
1/2-Wave Antenna (2)	Varies by band (see Antennas table for band-specific part numbers)
Hardware Kit (1)	90XN1371
2' BNC Cable (2)	95K2035
BNC Bulkhead Adapters (2)	95A8994
3' Ethernet Cable (1)	95B15103

Handheld Systems

Handheld Transmitter	ULXD2
Cartridge	see options below
Microphone Clip	95T9279
Zipper Bag	95B2313
AA Alkaline batteries (2)	80B8201
Battery Contact Cover	65A15947

Choice of one (1) of the following:

SM58	RPW112
SM86	RPW114
SM87A	RPW116
Beta 58A	RPW118
Beta 87A	RPW120
Beta 87C	RPW122

Bodypack System

Bodypack Transmitter	ULXD1
1/4-Wave Antenna	Varies by band (see Antennas table for band-specific part numbers)
Zipper Bag	95A2313
AA Alkaline batteries (2)	80B8201

Choice of one (1) of the following:

Instrument cable	WA302
Instrument Clip-on microphone	Beta 98H/C
Lavalier microphone	MX150, MX153, WL183, WL184, WL185
Headset microphone	WH30TQG

Antennas

Band	1/2-Wave Receiver Antennas	1/4-Wave Transmitter Antennas
G50	95AA9279	95G9043 (Yellow)
G51	95AA9279	95G9043 (Yellow)
G52	95AA9279	95G9043 (Yellow)
H51	95AL9279	95D9043 (Gray)
H52	95AL9279	95D9043 (Gray)
J50	95AK9279	95E9043 (Black)
K51	95AJ9279	95E9043 (Black)
L50	95AD9279	95E9043 (Black)
L51	95AD9279	95E9043 (Black)
P51	95AF9279	95F9043 (Blue)
R51	95M9279	95F9043 (Blue)
AB	95M9279	N/A
Q51	95M9279	N/A
X50	95V9279	95H9043 (Red)

Optional Accessories

Shure Rechargeable Battery	SB900
8-Bay Battery Charger	SBC800
Dual Docking Battery Charger	SBC200
Carrying Case	WA610
Y-Cable for Bodypack Transmitters	AXT652
Active Antenna Splitter	UA845SWB
Passive Antenna Splitter/Combiner Kit	UA221
UHF Line Amplifier	UA830WB
UHF Antenna Power Distribution Amplifier (U.S.A.)	UA844SWB
UHF Antenna Power Distribution Amplifier (Europe)	UA844SE
Front Mount Antenna Kit (Includes 2 cables and 2 bulkhead	UA600
Remote Antenna Bracket with BNC Bulkhead Adapter	UA505

UHF Powered Directional Antenna	UA874WB
Passive Directional Antenna	PA805SWB
Coaxial Cable, BNC-BNC, RG58C/U type, 50 Ohm, 2 ft length (0.6 m)	UA802
Coaxial Cable, BNC-BNC, RG58C/U type, 50 Ohm, 6 ft length (2 m)	UA806
Coaxial Cable, BNC-BNC, RG8X/U type, 50 Ohm, 25 ft length (7.5 m)	UA825
Coaxial Cable, BNC-BNC, RG8X/U type, 50 Ohm, 50 ft length (15 m)	UA850
Coaxial Cable, BNC-BNC, RG213/U Type, 50 Ohm, 100 ft length (30 m)	UA8100

Certifications

This Class B digital apparatus complies with Canadian ICES-003. Cet appareil numérique de la classe B est conforme à la norme NMB-003 du Canada.

ULXD1, ULXD2, ULXD4D, ULXD4Q

This product meets the Essential Requirements of all relevant European directives and is eligible for CE marking.

Meets requirements of the following standards: EN 300 422 Parts 1 and 2, EN 301 489 Parts 1 and 9.

ULXD1, ULXD2

Certified under FCC Part 74.

Certified by IC in Canada under RSS-123 and RSS-102.

IC: 616A-ULXD1 G50, 616A-ULXD1 J50, 616A-ULXD1 L50; 616A-ULXD2 G50, 616A-ULXD2 J50, 616A-ULXD2 L50.

FCC: DD4ULXD1G50, DD4ULXD1J50, DD4ULXD1L50; DD4ULXD2G50, DD4ULXD2J50, DD4ULXD2L50.

ULXD4D, ULXD4Q

Approved under the Declaration of Conformity (DoC) provision of FCC Part 15.

Certified in Canada by IC to RSS-123.

IC: 616A-ULXD4D G50, 616A-ULXD4D J50, 616A-ULXD4D L50; 616A-ULXD4Q G50, 616A-ULXD4Q J50, 616A-ULXD4Q L50.

Conforms to electrical safety requirements based on IEC 60065.

This device complies with Industry Canada licence-exempt RSS standard(s). Operation of this device is subject to the following two conditions: (1) this device may not cause interference, and (2) this device must accept any interference, including interference that may cause undesired operation of the device.

Le présent appareil est conforme aux CNR d'Industrie Canada applicables aux appareils radio exempts de licence. L'exploitation est autorisée aux deux conditions suivantes : (1) l'appareil ne doit pas produire de brouillage, et (2) l'utilisateur de l'appareil doit accepter tout brouillage radioélectrique subi, même si le brouillage est susceptible d'en compromettre le fonctionnement.

Note: EMC conformance testing is based on the use of supplied and recommended cable types. The use of other cable types may degrade EMC performance.

The CE Declaration of Conformity can be obtained from Shure Incorporated or any of its European representatives. For contact information please visit www.shure.com

The CE Declaration of Conformity can be obtained from: www.shure.com/europe/compliance

Authorized European representative:
Shure Europe GmbH
Headquarters Europe, Middle East & Africa
Department: EMEA Approval
Jakob-Dieffenbacher-Str. 12
75031 Eppingen, Germany
Phone: 49-7262-92 49 0
Fax: 49-7262-92 49 11 4
Email: EMEAsupport@shure.de

LICENSING INFORMATION

Licensing: A ministerial license to operate this equipment may be required in certain areas. Consult your national authority for possible requirements. Changes or modifications not expressly approved by Shure Incorporated could void your authority to operate the equipment. Licensing of Shure wireless microphone equipment is the user's responsibility, and licensability depends on the user's classification and application, and on the selected frequency. Shure strongly urges the user to contact the appropriate telecommunications authority concerning proper licensing, and before choosing and ordering frequencies.

Information to the user

This equipment has been tested and found to comply with the limits for a Class B digital device, pursuant to Part 15 of the FCC Rules. These limits are designed to provide reasonable protection against harmful interference in a residential installation. This equipment generates uses and can radiate radio frequency energy and, if not installed and used in accordance with the instructions, may cause harmful interference to radio communications. However, there is no guarantee that interference will not occur in a particular installation. If this equipment does cause harmful interference to radio or television reception, which can be determined by turning the equipment off and on, the user is encouraged to try to correct the interference by one or more of the following measures:

- Reorient or relocate the receiving antenna.
- Increase the separation between the equipment and the receiver.
- Connect the equipment to an outlet on a circuit different from that to which the receiver is connected.
- Consult the dealer or an experienced radio/TV technician for help.



WARNING: Danger of explosion if battery incorrectly replaced. Operate only with Shure compatible batteries.

Note: Use this receiver only with the included power supply or a Shure-approved equivalent.

WARNING

- Battery packs may explode or release toxic materials. Risk of fire or burns. Do not open, crush, modify, disassemble, heat above 140°F (60°C), or incinerate
- Follow instructions from manufacturer
- Never put batteries in mouth. If swallowed, contact your physician or local poison control center
- Do not short circuit; may cause burns or catch fire
- Do not charge or use battery packs with other than specified Shure products
- Dispose of battery packs properly. Check with local vendor for proper disposal of used battery packs
- Batteries (battery pack or batteries installed) shall not be exposed to excessive heat such as sunshine, fire or the like

FREQUENCIES FOR EUROPEAN COUNTRIES

ULXD-G51 470 - 534 MHz, max. 20 mW	
Country Code	Frequency Range
Code de Pays	Gamme de frequences
Codice di paese	Gamme di frequenza
Código de país	Gama de frecuencias
Länder-Kürzel	Frequenzbereich
A, B, BG, CH, CY, CZ, D, EST	470 - 534 MHz *
F, GB, GR, H, I, IS, L, LT	470 - 534 MHz *
NL, P, PL, S, SK, SLO	470 - 534 MHz *
DK, FIN, M, N	*
HR, E, IRL, LV, RO, TR	*
All other countries	*

ULXD-P51 710 - 782 MHz, max. 20 mW	
Country Code	Frequency Range
Code de Pays	Gamme de frequences
Codice di paese	Gamme di frequenza
Código de país	Gama de frecuencias
Länder-Kürzel	Frequenzbereich
A, B, BG, CH, CY, CZ, D, EST, F, GB,	710 - 782 MHz *
GR, H, I, IS, L, LT, NL, P, PL, S, SK, SLO	710 - 782 MHz *
RO	"718-719; 726-727; 734-743; 750-751; 758-759 MHz"
DK, E, FIN, HR, IRL, LV, M, N, TR	*
all other countries	*

ULXD-H51 534 - 598 MHz, max. 20 mW	
Country Code	Frequency Range
Code de Pays	Gamme de frequences
Codice di paese	Gamme di frequenza
Código de país	Gama de frecuencias
Länder-Kürzel	Frequenzbereich
A, B, BG, CH, CY, CZ, D, EST	534 - 598 MHz *
F, GB, GR, H, I, IS, L, LT	534 - 598 MHz *
NL, P, PL, S, SK, SLO	534 - 598 MHz *
DK, FIN, M, N	*
HR, E, IRL, LV, RO, TR	*
All other countries	*

ULXD-R51 800 - 810 MHz, max. 20 mW	
Country Code	Frequency Range
Code de Pays	Gamme de frequences
Codice di paese	Gamme di frequenza
Código de país	Gama de frecuencias
Länder-Kürzel	Frequenzbereich
N	800 - 810 MHz*
A, B, BG, CH, CY, CZ, D, DK, E, EST	*
F, FIN, GB, GR, H, HR, I, IRL, IS, L, LT	*
LV, M, N, NL, P, PL, S, SK, SLO, TR	*
All other countries	*

ULXD-K51 606 - 670 MHz, max. 20 mW	
Country Code	Frequency Range
Code de Pays	Gamme de frequences
Codice di paese	Gamme di frequenza
Código de país	Gama de frecuencias
Länder-Kürzel	Frequenzbereich
A, B, BG, CH, CY, CZ, D, EST	606 - 670 MHz *
F, GB, GR, H, I, IS, L, LT	606 - 670 MHz *
NL, P, PL, S, SK, SLO	606 - 670 MHz *
RO	646-647;654-655;662-663 MHz*
DK, E, FIN, HR, IRL, LV, M, N, TR	*
All other countries	*

* IMPORTANT

NOTE: THIS EQUIPMENT MAY BE CAPABLE OF OPERATING ON SOME FREQUENCIES NOT AUTHORIZED IN YOUR REGION. PLEASE CONTACT YOUR NATIONAL AUTHORITY TO OBTAIN INFORMATION ON AUTHORIZED FREQUENCIES AND RF POWER LEVELS FOR WIRELESS MICROPHONE PRODUCTS IN YOUR REGION.

A ministerial license may be required to operate this equipment in certain areas. Consult your national authority for possible requirements.

* WICHTIG

HINWEIS: DIESES GERÄT KANN MÖGLICHERWEISE AUF EINIGEN FREQUENZEN ARBEITEN, DIE IN IHREM GEBIET NICHT ZUGELASSEN SIND. WENDEN SIE SICH BITTE AN DIE ZUSTÄNDIGE BEHÖRDE, UM INFORMATIONEN ÜBER ZUGELASSENE FREQUENZEN UND ERLAUBTE SENDELEISTUNGEN FÜR DRAHTLOSE MIKROFONPRODUKTE IN IHREM GEBIET ZU ERHALTEN.

Zulassung: In einigen Gebieten ist für den Betrieb dieses Geräts u.U. eine behördliche Zulassung erforderlich. Wenden Sie sich bitte an die zuständige Behörde, um Informationen über etwaige Anforderungen zu erhalten.

*IMPORTANT

REMARQUE: IL EST POSSIBLE QUE CE MATÉRIEL SOIT CAPABLE DE FONCTIONNER SUR CERTAINES FRÉQUENCES NON AUTORISÉES LOCALEMENT. SE METTRE EN RAPPORT AVEC LES AUTORITÉS COMPÉTENTES POUR OBTENIR LES INFORMATIONS SUR LES FRÉQUENCES ET NIVEAUX DE PUISSANCE HF AUTORISÉES POUR LES SYSTÈMES DE MICROPHONES SANS FIL LOCALEMENT.

Autorisation d'utilisation : Une licence officielle d'utilisation de ce matériel peut être requise dans certains pays. Consulter les autorités compétentes pour les exigences possibles.

*IMPORTANTE

NOTA: QUESTO APPARECCHIO PUÒ ESSERE IN GRADO DI FUNZIONARE A FREQUENZE NON AUTORIZZATE NELLA REGIONE IN CUI SI TROVA L'UTENTE. RIVOLGERSI ALLE AUTORITÀ COMPETENTI PER OTTENERE LE INFORMAZIONI RELATIVE ALLE FREQUENZE ED AI LIVELLI DI POTENZA RF AUTORIZZATE NELLA PROPRIA REGIONE PER I PRODOTTI MICROFONICI SENZA FILI.

Concessione della licenza all'uso: per usare questo apparecchio, in certe aree può essere necessaria una licenza ministeriale. Per i possibili requisiti, rivolgersi alle autorità competenti.

*IMPORTANTE

NOTA: ES POSIBLE QUE ESTE EQUIPO FUNCIONE EN ALGUNAS FRECUENCIAS NO AUTORIZADAS EN SU REGION. POR FAVOR CONTACTE A LA AUTORIDAD NACIONAL PARA OBTENER INFORMACION ACERCA DE LAS FRECUENCIAS AUTORIZADAS Y LOS NIVELES DE POTENCIA DE RADIOFRECUENCIA PARA PRODUCTOS CON MICROFONOS INALAMBRICOS EN SU ZONA.

Licencia de uso: Se puede requerir una licencia ministerial para utilizar este equipo en algunas áreas. Consulte a la autoridad nacional sobre los posibles requisitos.



United States, Canada, Latin America, Caribbean:
Shure Incorporated
5800 West Touhy Avenue
Niles, IL 60714-4608 USA

Phone: 847-600-2000
Fax: 847-600-1212 (USA)
Fax: 847-600-6446
Email: info@shure.com

www.shure.com

©2012 Shure Incorporated

Europe, Middle East, Africa:

Shure Europe GmbH
Jakob-Dieffenbacher-Str. 12,
75031 Eppingen, Germany

Phone: 49-7262-92490
Fax: 49-7262-9249114
Email: info@shure.de

Asia, Pacific:

Shure Asia Limited
22/F, 625 King's Road
North Point, Island East
Hong Kong

Phone: 852-2893-4290
Fax: 852-2893-4055
Email: info@shure.com.hk

PT. GOSHEN SWARA INDONESIA

Kompleks Harco Mangga Dua Blok L No. 35 Jakarta Pusat

I.16.GSI31.00501.0211