



# SR 2020-D

Instruction manual

**SENNHEISER**

# Important safety instructions

1. Read these safety instructions and the instruction manual of the product.
2. Keep these safety instructions and the instruction manual of the product. Always include all instructions when passing the product on to third parties.
3. Heed all warnings.
4. Follow all instructions.
5. Do not use this apparatus near water.
6. Only clean the product when it is not connected to the power supply system. Clean only with a dry cloth.
7. Do not block any ventilation openings. Install in accordance with the manufacturer's instructions.
8. Do not install near any heat sources such as radiators, heat registers, stoves, or other apparatus (including amplifiers) that produce heat.
9. Only operate the product from the type of power source specified in the chapter „Specifications“ and indicated on the power supply unit.
10. Protect the power cord from being walked on or pinched, particularly at plugs, convenience receptacles, and the point where it exits from the apparatus.
11. Only use attachments/accessories specified by the manufacturer.
12. Use only with the cart, stand, tripod, bracket, or table specified by the manufacturer, or sold with the apparatus. When a cart is used, use caution when moving the cart/apparatus combination to avoid injury from tip-over.
13. Unplug the power supply unit from the wall socket,
  - to completely disconnect the product from the power supply system,
  - during lightning storms,
  - when not using the product for long periods of time.
14. Refer all servicing to qualified service personnel. Servicing is required when the apparatus has been damaged in any way, such as power-supply cord or plug is damaged, liquid has been spilled or objects have fallen into the apparatus, when the apparatus has been exposed to rain or moisture, does not operate normally, or has been dropped.
15. Only use the supplied power supply unit.
16. Warning: To reduce the risk of fire or electric shock, do not expose this apparatus to rain or moisture and objects filled with liquids, such as vases, should not be placed on this apparatus.
17. When using the supplied device feet, do not place the product on delicate surfaces. Delicate surfaces can become discolored or stained when they come into contact with the plastic of the device feet.
18. Always ensure that the power supply unit is
  - in a safe operating condition and easily accessible,
  - properly plugged into the wall socket,
  - only operated within the permissible temperature range,
  - not covered or exposed to direct sunlight for longer periods of time in order to prevent heat accumulation.

## Important safety instructions

### Risk of fire due to overloading

Do not overload wall outlets and extension cables as this may result in fire and electric shock.

### Replacement parts

When replacement parts are required, be sure the service technician uses replacement parts specified by Sennheiser or those having the same characteristics as the original part. Unauthorized substitutions may result in fire, electric shock, or other hazards.

### Danger due to high volume levels

This product is used for commercial purposes. Commercial use is subject to the rules and regulations of the trade association responsible. Sennheiser, as the manufacturer, is therefore obliged to expressly point out possible health risks arising from use.

This product is capable of producing sound pressure levels exceeding 85 dB(A). 85 dB(A) is the sound pressure corresponding to the maximum permissible volume which is by law (in some countries) allowed to affect your hearing for the duration of a working day. It is used as a basis according to the specifications of industrial medicine. Higher volumes or longer durations can damage your hearing. At higher volumes, the duration must be shortened in order to prevent hearing damage.

The following are sure signs that you have been subjected to excessive noise for too long a time:

- You can hear ringing or whistling sounds in your ears.
- You have the impression (even for a short time only) that you can no longer hear high notes.

Inform all users of these risks and ask them to set the volume to a moderate level if necessary.

### Intended use

The product is designed for indoor and outdoor use.

The product can be used for commercial purposes.

It is considered improper use when the product is used for any application not named in the corresponding instruction manual.

Sennheiser does not accept liability for damage arising from improper use or misuse of this product and its attachments/accessories.

Before putting the products into operation, please observe the respective country-specific regulations!

Sennheiser is not liable for damages resulting from the loss of connection due to flat or overaged (rechargeable) batteries or exceeding the transmission range.

## Delivery includes

- SR 2020-D transmitter
- NT 2-3 mains unit
- Telescopic antenna
- GA 2 rack adapter, consisting of
  - 2 rack mount “ears”
  - Blanking plate
  - Jointing plate
  - 2 blanking plugs for closing off unused BNC holes
  - 12 recessed head screws M 3x6
  - 2 recessed head screws M 6x10
- 4 device feet
- Instruction manual
- Manufacturer declarations

## System components

The SR 2020-D transmitter allows the stationary use of the Tourguide 2020-D system.

The transmitter can be combined with the following individual components:

- HDE 2020-D-II stethoset receivers
- EK 2020-D-II receivers

## Tourguide system overview

Together with the SR 2020-D transmitter, the Tourguide 2020-D system offers optimum digital speech transmission for the following applications:

- simultaneous interpretations and
- stationary guided tours

### Areas of application

#### Simultaneous interpretations during conferences (“Conference” mode)

The main application of the stationary SR 2020-D transmitter is its use for simultaneous interpretations during conferences.

Eight fixed transmission frequencies allow for interference-free simultaneous interpretations in up to eight languages (see “Transmitting several languages simultaneously” on page 17).

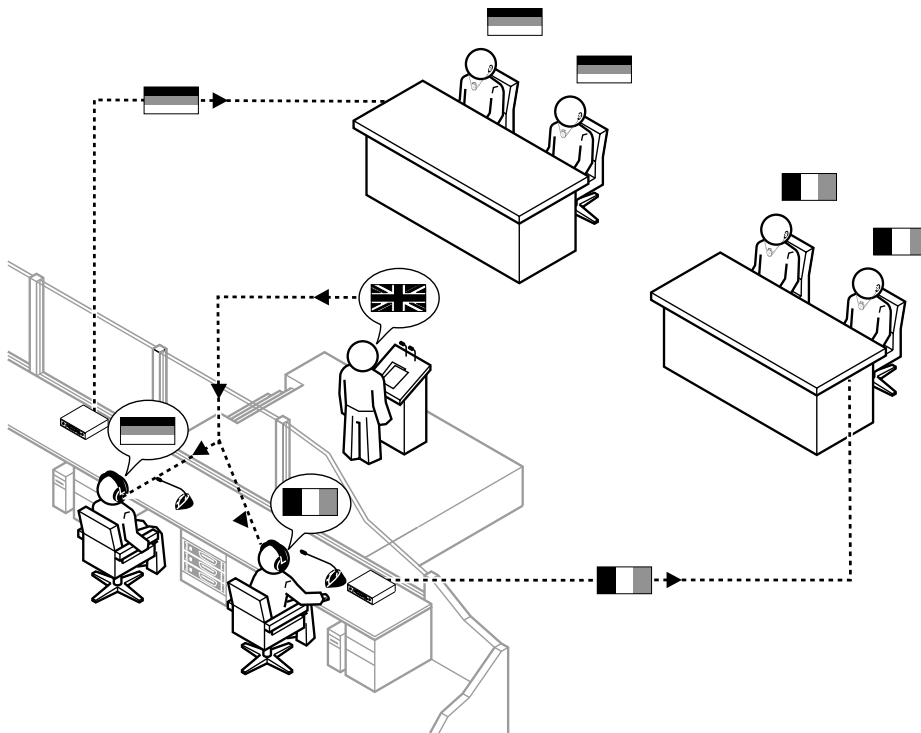

## Stationary guided tours (“Tourguide“ mode)

With a stationary guided tour, both the group and the transmitters are in a fixed location.

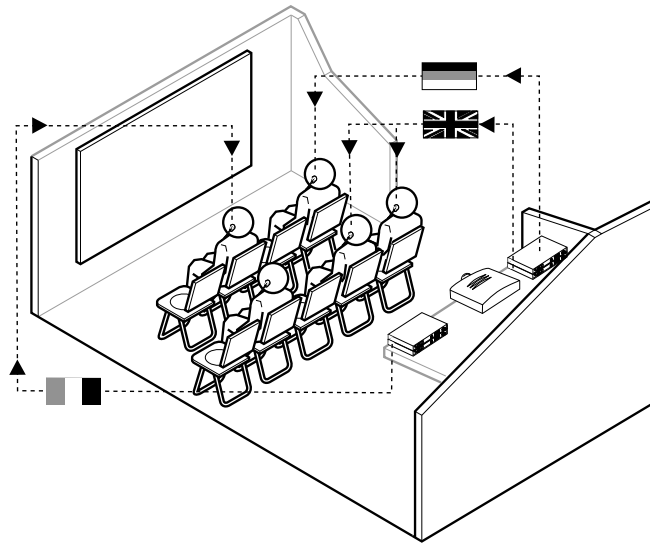

Examples for stationary guided tours are multimedia presentations, movie shows as well as boat and bus tours in several languages.

Six fixed transmission frequencies allow for simultaneous transmission in up to six languages (see “Transmitting several languages simultaneously” on page 17).

The Tourguide 2020-D system operates in the 863 MHz–865 MHz frequency band, which is license-free in Europe (see „Specifications“ on page 22).

## Connection possibilities

You can connect one of the following phantom-powered Sennheiser condenser microphones (not included) to the SR 2020-D transmitter:

- ME 34, ME 35, ME 36

In addition, you can connect an audio source to the transmitter:

- Conference/interpretation systems
- MP3 player
- CD /DVD player

# Product overview

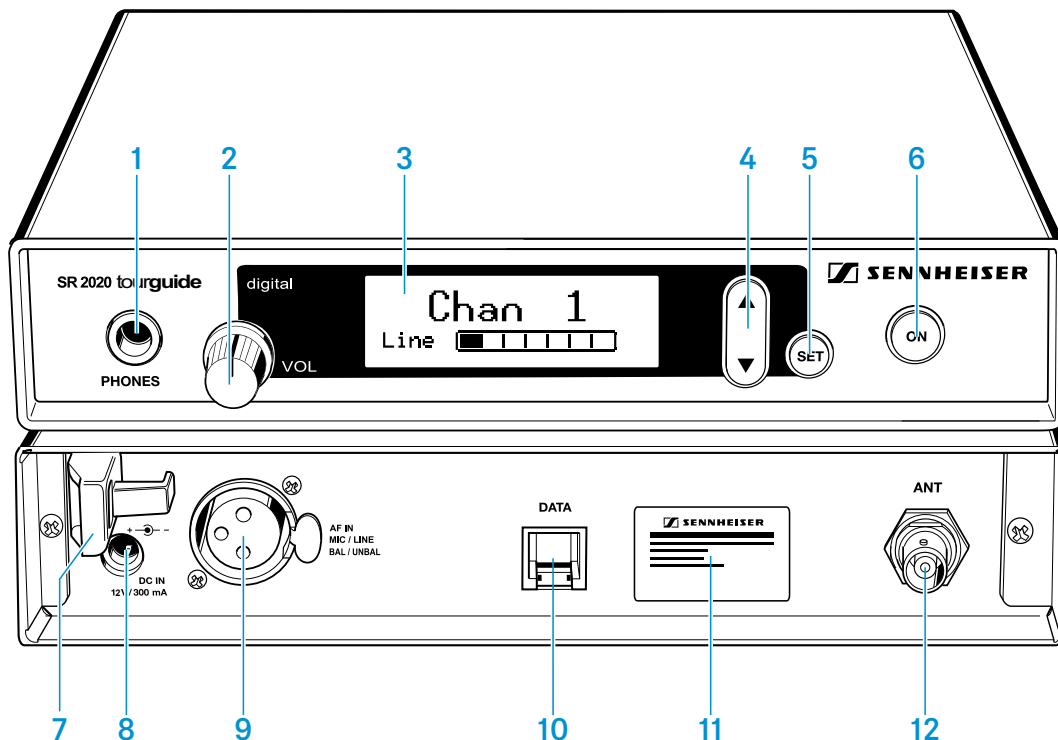

- |  |   |
|--|---|
| <ul style="list-style-type: none"> <li>1 Headphone output (<b>PHONES</b>), ¼" (6.3 mm) jack socket</li> <li>2 Headphone volume control (<b>VOL</b>)</li> <li>3 Display, backlit</li> <li>4 rocker button ▲/▼, backlit</li> <li>5 <b>SET</b> button, backlit</li> <li>6 <b>ON</b> button, backlit (serves as the ESC (cancel) key in the operating menu)</li> </ul> | <ul style="list-style-type: none"> <li>7 Cable grip for mains cable</li> <li>8 Socket for connection of mains unit (<b>DC IN 12 V/300 mA</b>)</li> <li>9 Audio input (<b>AF IN MIC/LINE</b>), XLR-3F socket</li> <li>10 Service interface (<b>DATA</b>)</li> <li>11 Type plate</li> <li>12 Antenna output (<b>ANT</b>), BNC socket</li> </ul> |
|--|---|

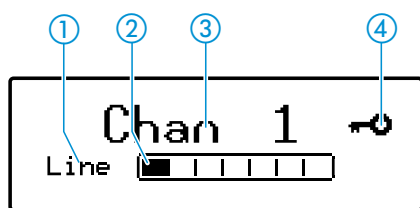

- ① Display for the selected signal source („Mic“/„Line“)
- ② **Mic-/Line** level display
- ③ Channel display
- ④ Lock mode icon (lock mode is activated)

## Indications and displays on the transmitter

### Display for the selected signal source (Mic/Line)

You can connect either a condenser microphone or an external audio source to the transmitter.

If you connect a condenser microphone, select “**Mic**” via the operating menu. If you connect an external audio source, select “**Line**” (see page 19).

“**Mic**” or “**Line**” appears on the display ①.



**Note:** If the “**Mic**” microphone input is selected but no microphone is connected, “**No Mic**” appears on the display.

### Mic/Line level display

The **Mic-/Line** level display ② shows the input level.

When the transmitter’s audio input level is excessively high, the **Mic-/Line** level display ② shows full deflection.

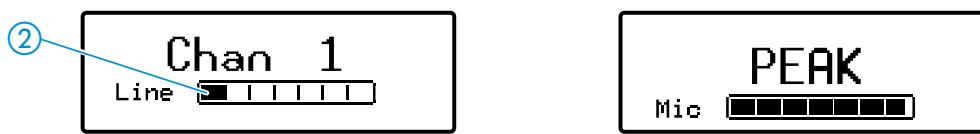

In addition, the display panel is in backlit in red and the text “**PEAK**” flashes in alternation with the channel display (see page 19).

### Channel display

The channel display ③ provides information on the currently selected channel (see page 17).



### Lock mode icon

The lock mode icon ④ appears when the lock mode is activated (see page 20).

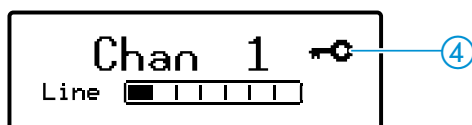



# Putting the SR 2020-D into operation

## Preparing the transmitter for use

You can set up the SR 2020-D transmitter on an even surface or mount it into a 19" rack.

**Note:** Do not fit the rubber feet when rack mounting the transmitter.

### Setting up the transmitter on an even surface

To ensure that the transmitter cannot slip on the surface on which it is placed, four self-adhesive soft rubber feet are supplied.

---

## CAUTION

### RISK OF STAINING OF FURNITURE SURFACES!

Some furniture surfaces have been treated with varnish, polish or synthetics which might cause stains when they come into contact with other synthetics.

Despite a thorough testing of the synthetics used by us, we cannot rule out the possibility of staining.

- ▷ Do not place the transmitter on delicate surfaces.
- 
- ▷ Ensure that the base of the transmitter is clean and free from grease before mounting the rubber feet.
  - ▷ Fix the rubber feet to the base of the transmitter by peeling of the safety paper and fitting them as shown in the diagram.

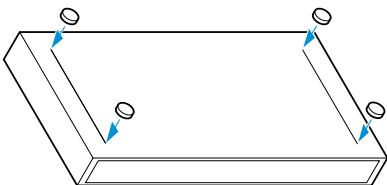

### Connecting the antenna

- ▷ Connect the telescopic antenna to the antenna output **12** at the rear of the transmitter.

To obtain the best possible radiation power:

- ▷ Align the antenna vertically.

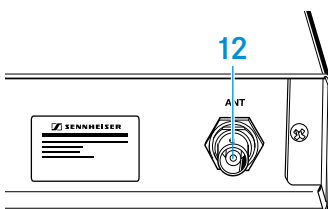

## Rack-mounting

---

### CAUTION

#### RISKS WHEN RACK MOUNTING THE TRANSMITTER!

When installing the device in a closed or multi-rack assembly, please consider that, during operation, the ambient temperature, the mechanical loading and the electrical potentials will be different from those of devices which are not mounted into a rack:

- ▷ The ambient temperature within the rack must not exceed the temperature limit specified in the specifications.
  - ▷ When installing the device in a rack, take good care not to affect the ventilation required for safe operation. If necessary, provide additional ventilation.
  - ▷ Make sure the mechanical loading of the rack is even to avoid a hazardous condition such as a severely unbalanced rack.
  - ▷ When connecting the device to the mains, observe the information indicated on the type plate. Avoid circuit overloading. If necessary, provide overcurrent protection.
  - ▷ When installing the device in a closed or multi-rack assembly, please note that intrinsically harmless leakage currents of the individual mains units may accumulate, thereby exceeding the allowable limit value. As a remedy, ground the rack via an additional ground connection.
- 

### Mounting the antennas to the front or rear of the rack

For the best possible radiation power, you should align the antennas vertically. If this is not possible, use one of the optional antenna mounts (see “Accessories and spare parts” on page 25):

- You mount 1 transmitter: Antenna mount AM 2
- You mount 2 transmitters: Antenna mount GA 3030 AM

When using several transmitters simultaneously, make sure that, in order to avoid interference, the distance between the antennas is sufficient. If necessary, use active transmitter combiners (see “Accessories and spare parts” on page 25):

- You mount 4 transmitter: Active Transmitter Combiner AC 3
- You mount 8 transmitters: Active Transmitter Combiner AC 3200-II

If you want to mount the antennas outside the rack, you can use remote antennas (see “Accessories and spare parts” on page 25).

## Putting the SR 2020-D into operation

### Mounting two SR 2020-D side by side

- ▷ Place the two transmitters side by side upside-down onto a flat surface.
- ▷ Align the jointing plate 15 over the holes in the bottom sides of the transmitters.
- ▷ Secure the jointing plate 15 to the transmitters using eight of the supplied recessed head screws (M 3x6).
- ▷ Hook the two rack mount “ears” 14 to the front panels of the transmitters.
- ▷ Secure the rack mount “ears” 14 to the transmitters using two of the supplied recessed head screws (M 3x6) respectively. If you wish to mount the antenna connections to the front of the rack, use the rack mount “ears” of the optional GA 3030 AM antenna mount.
- ▷ Slide the transmitters into the 19" rack.
- ▷ Secure the rack mount “ears” 14 to the rack.

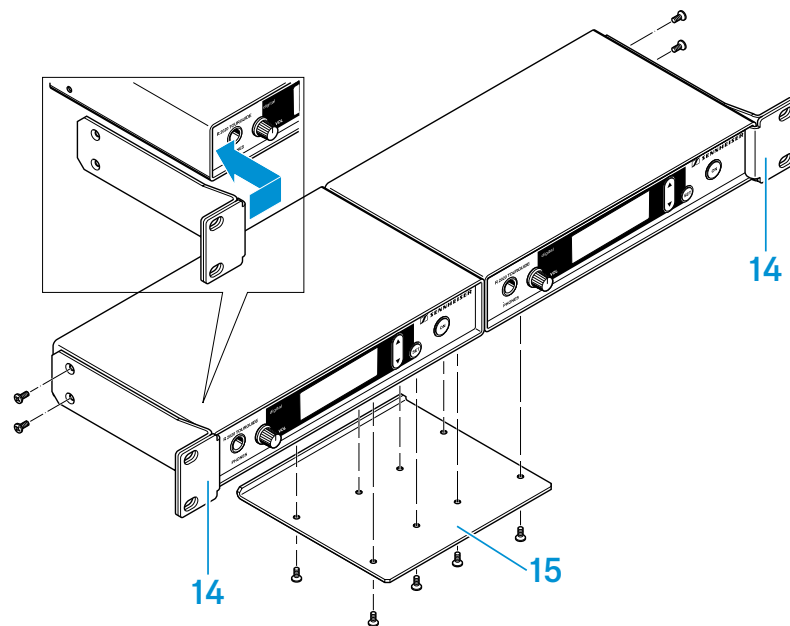

### Mounting only one SR 2020-D

When mounting only one transmitter into the rack, use the blanking plate 13 instead of the second transmitter.

- ▷ Hook the two rack mount “ears” 14 to the front panel of the transmitter.
- ▷ Secure the rack mount “ears” 14 to the transmitter using two of the supplied recessed head screws (M 3x6) respectively.
- ▷ Secure the blanking plate 13 to one of the rack mount “ears” 14 using two of the supplied recessed head screws (M 6x10).
- ▷ If you are not front mounting the BNC output connector, insert the two blanking plugs 16 into the holes of the blanking plate.
- ▷ Slide the transmitter into the 19" rack.
- ▷ Secure the rack mount “ears” 14 to the rack.

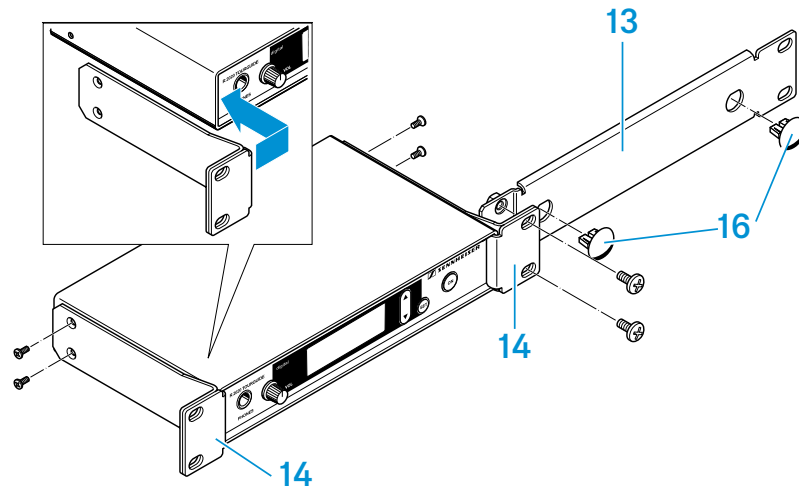

## Connecting the transmitter to the mains

- ▷ Pass the cable through the cable grip 7.
- ▷ Connect the cable of the mains unit to the DC IN socket 8 of the transmitter.
- ▷ Plug the mains connector into the wall socket.

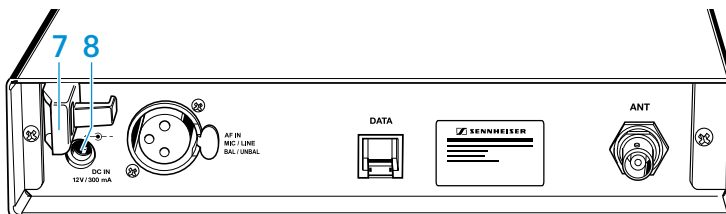

## Connecting external devices

You can connect either a microphone (**Mic**) or an external audio source (**Line**, e.g. CD or MP3 player) to the transmitter.

To do so, use a suitable audio cable with a length of up to 3 m.

## Connecting an external audio source to the transmitter

- ▷ Connect the line output of the external audio source to the XLR-3F socket 9 of the transmitter.

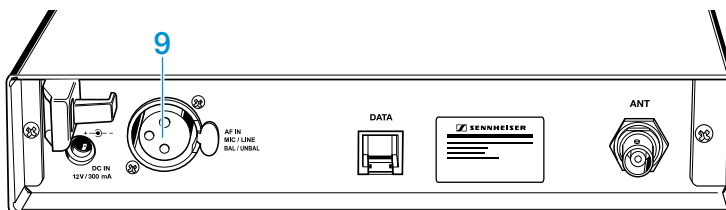

## Putting the SR 2020-D into operation

### Connecting a condenser microphone

The microphone input of the SR 2020-D transmitter is exclusively designed for use with condenser microphones. Suitable microphones are listed on page 5.

- ▷ Connect the condenser microphone to the XLR-3F socket 9 of the transmitter.

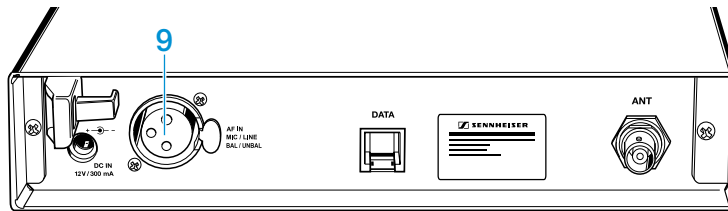

### Connecting the headphones

The **Mic/Line** level display ② displays the strength of the input signal (see page 7). The SR 2020-D transmitter also features a headphone output for monitoring purposes.

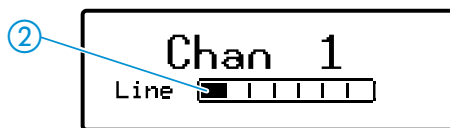

---

#### CAUTION

##### DANGER OF HEARING DAMAGE!

Listening at high volume levels for long periods can lead to permanent hearing defects.

- ▷ Use the headphone volume control (**VOL**) 2 to set the volume for the connected headphones to the minimum before putting the headphones on.

---

To monitor the audio signal via headphones:

- ▷ Set the headphone volume control 2 to the lowest volume by turning it to the left as far as possible.
- ▷ Connect headphones with a ¼" (6.3 mm) stereo jack plug to the headphone output 1.
- ▷ Put the headphones on.
- ▷ Gradually turn up the volume.

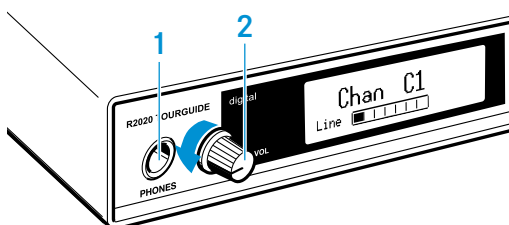

# Operating the SR 2020-D

## Switching the transmitter on/off

To switch the transmitter on:

- ▷ Press the **ON** button 6.

The display panel indicates the device name and then switches to the standard display.

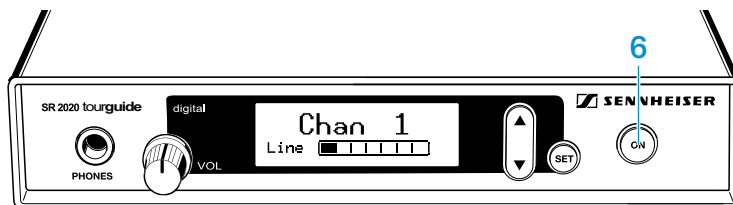

To switch the transmitter off:

- ▷ Press the **ON** button 6 until "OFF" appears on the display.
- ▷ Release the **ON** button 6.

The display panel goes off and the transmitter switches off.

**Note:** The transmitter can only be switched off when the standard display is shown on the display panel. When in the operating menu, the **ON** button 6 serves as the ESC (cancel) key, i.e. you cancel your entry and return to the standard display.

## Working with the operating menu

By way of example of the „**Chan. mode**“ menu (**Channel mode**) this section describes how to use the operating menu.

For an overview of the operating menu, please see page 19.

- ▷ Make sure that the lock mode is deactivated (see page 18).

## Getting into the operating menu

To get from the standard display into the operating menu:

- ▷ Press the **SET** button 5.

The „**Channel**“ menu is highlighted with a black bar.

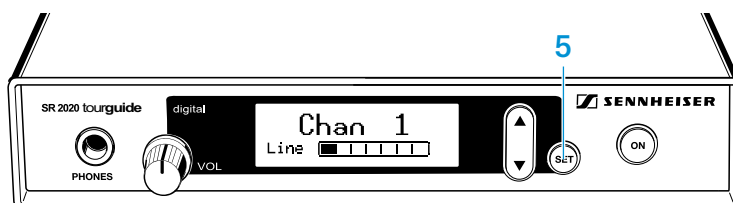

## Operating the SR 2020-D

### Selecting a menu

- ▷ Use the ▲/▼ rocker button 4 to select the „Chan. mode“ menu:

#### Rocker button

- press ▲
- press ▼
- keep ▲ or ▼ pressed

#### Display

- jumps to the previous menu
- jumps to the next menu
- cycles continuously

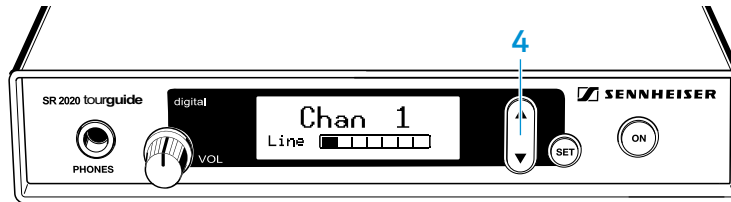

- ▷ Press the SET button 5 to get into the setting mode of the „Chan. mode“ menu. The current setting of the menu is displayed.

### Adjusting a setting in the setting mode

- ▷ Use the ▲/▼ rocker button 4 to jump between the settings.

### Storing a setting

- ▷ Press the SET button 5 to store the selected setting. „STORED“ briefly appears on the display.

### Exiting a menu

- ▷ Press the ON button 6 to return to the operating menu.

### Exiting the operating menu

- ▷ Use the ▲/▼ rocker button 4 to select the „Exit“ menu and press the SET button 5. The standard display is shown on the display panel.

Or:

- ▷ Press the ON button 6 until the standard display is shown on the display panel.

## Selecting the menus

The transmitter's operating menu contains the following menus:

Menu	Function of the menu
"Channel"	Selecting a channel (see page 15)
"Frequency"	Displaying the frequency of the current channel (see page 16)
"Chan. mode"	Selecting the channel mode (see page 16)
"Input"	Selecting the input signal (see page 17)
"Sensitiv"	Adjusting the input sensitivity (see page 17)
"Phantom"	Displaying the phantom power (see page 17)
"Contrast"	Adjusting the contrast (see page 17)
"Lock"	Activating/deactivating the lock mode (see page 18)
"Reset"	Loading the factory-preset default settings (see page 18)
"Version"	Displaying the current software version (see page 18)
"Exit"	Exiting the operating menu

### Setting a channel ("Channel")

To set a certain channel, proceed as follows:

- ▷ Make sure that the transmitter and the receivers are set to the **same** channel mode ("Tourguide" or "Conference"), otherwise no connection can be established (see page 16).
- ▷ Set the SR 2020-D transmitter to the desired channel (see next section).
- ▷ Set one of the receivers to the same channel.
- ▷ Automatically set all other receivers to the same channel using the channel copy function (for information on the channel copy function, please refer to the instruction manual of the Tourguide 2020 system).

To set the transmitter to the desired channel:

- ▷ Select the „Channel“ menu.  
„Channel“ appears on the display and the current channel is shown.
- ▷ the ▲/▼ rocker button 4 to change the channel.
- ▷ Press the SET button 5 to store the selected channel.

### Transmitting several languages simultaneously

In order to be able to transmit several languages simultaneously, you require one SR 2020-D transmitter and one or several receivers per language:

- ▷ Set the transmitter and the receivers assigned to certain language to the same channel.
- ▷ Do not use this channel for any other language.



## Displaying the frequency of the selected channel (“Frequency”)

You can display the frequency of the selected channel. This function is useful, if you are using other Tourguide systems in the vicinity which interfere with your transmission (see previous section).

- ▷ Select the „Frequency“ menu.  
„Frequency“ appears on the display and the frequency of the current channel is shown.

## Changing the channel mode (“Chan. mode”)

You can choose between the two channel modes “Conference” and “Tourguide”. The two modes have been designed for different applications and differ from each other in the number of available channels:

Channel mode	Application	Number of channels
Conference	Simultaneous interpretations	8
Tourguide	Tourguide systems	6

To change the channel mode:

- ▷ Select the „Chan. mode“ menu.
- ▷ Use the ▲/▼ rocker button 4 to to change the channel mode („Tourguide“/„Conference“).
- ▷ Press the SET button 5 to store the selected channel mode.

## Display of the channel mode

The selected channel mode appears on the standard display as follows:

Display



Channel mode

„Tourguide“



„Conference“

## Selecting the input signal (“Input”)

You can connect either a condenser microphone or any other audio source (e.g. CD and MP3 player, see page 5) to the transmitter.

To select the input signal:

- ▷ Select the „Input“ menu.
- ▷ Press the SET button 5 to display the current setting („Mic“/„Line“).
- ▷ Use the ▲/▼ rocker button 4 to select the desired input signal:

You connect ...	Select
a condenser microphone?	„Mic“
an external audio source?	„Line“

- ▷ Press the SET button 5 to store the selected input signal.

## Adjusting the sensitivity of the Mic/Line input (“Sensitiv”)

If you connect a microphone to the transmitter, the microphone signal **has to be** amplified by the transmitter. Other audio sources **can be** amplified, if their audio signal is too low (see page 17).

To adjust the input sensitivity:

- ▷ Select the „Sensitiv“ menu.
- ▷ Use the ▲/▼ rocker button 4 to change the setting. The Mic/Line level display ② should show full deflection during the loudest passages.
- ▷ Press the SET button SET 5 to store the input sensitivity of the Mic / Line input.

## Displaying the phantom power (“Phantom”)

When you activate the transmitter’s microphone input, the phantom power is automatically available (see page 17). The display show the value of the phantom power.

## Adjusting the contrast of the display (“Contrast”)

To adjust the contrast of the display to the ambient light:

- ▷ Select the „Contrast“ menu.  
„Contrast“ appears on the display and the current setting is shown.
- ▷ Use the ▲/▼ rocker button 4 to change the setting.
- ▷ Press the SET button 5 to store the setting.

### Activating/deactivating the lock mode (“Lock”)

The lock mode prevents that the transmitter is accidentally programmed or switched off during operation.

To **activate** the lock mode:

- ▷ Select the „**Lock**“ menu.
- ▷ Select the setting „**Lock On**“.
- ▷ Press the **SET** button **5**.

The lock mode is activated and the lock mode icon appears on the standard display.

To **deactivate** the lock mode:

- ▷ Press the **SET** button **5**.  
„**Lock On**“ appears on the display.
- ▷ Select the setting „**Lock Off**“.
- ▷ Press the **SET** button **5** to deactivate the lock mode.

The lock mode icon disappears from the standard display.

### Loading the factory-preset default settings (“Reset”)

- ▷ Select the „**Reset**“ menu.  
„**Reset No**“ appears on the display.
- ▷ Press the ▲/▼ rocker button **4** until „**Reset Yes**“ appears on the display.
- ▷ Press the **SET** button **5** to reset the device to the factory-preset default settings.  
„**DONE**“ appears on the display. The transmitter is reset to the following factory-preset default settings:
  - Channel mode: Tourguide
  - Input signal: Line input
  - Channel: 1
  - Input sensitivities:
    - Line input: 0 dB
    - Microphone input: 0 dB
  - Lock mode: deactivated

### Displaying the version number of the software (“Version”)

**Note:** This function is for servicing purposes only.

To display the version number:

- ▷ Select the “**Version**” menu.  
The version number appears on the display.

# Overview of the operating menu

Pressing the ON button 6 will cancel your entry in all menu modes.

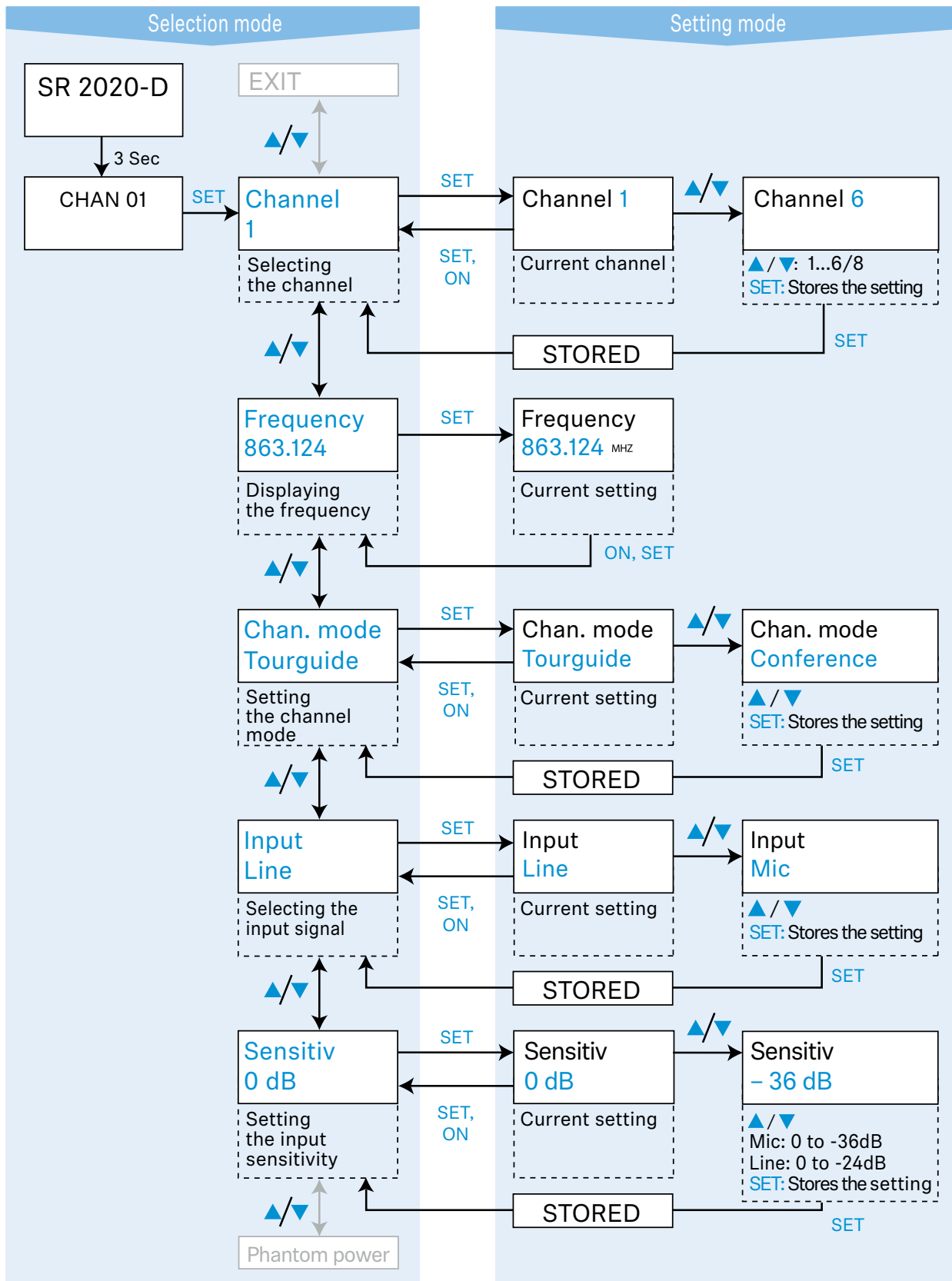

# Operating the SR 2020-D

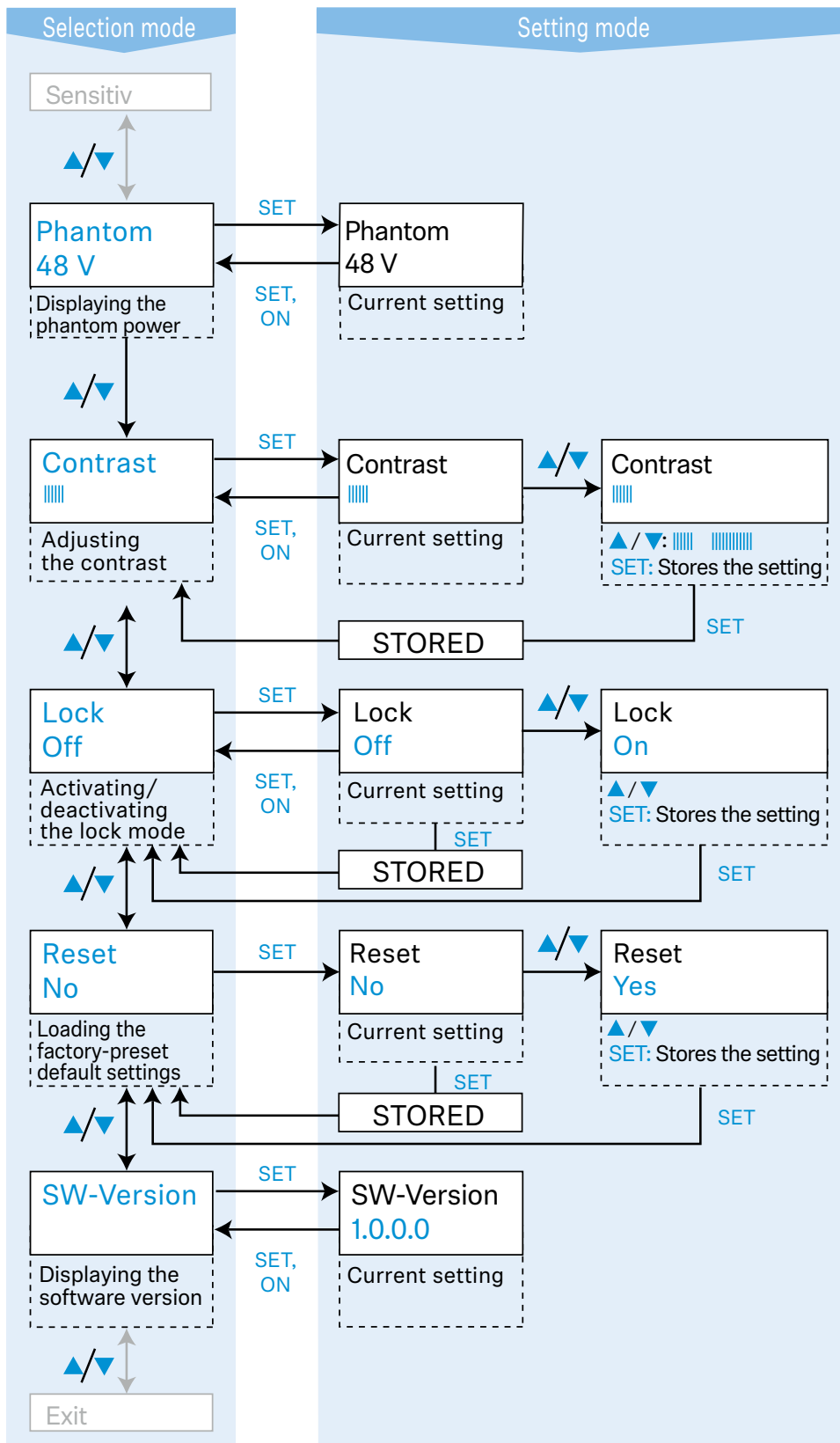

# Cleaning the SR 2020-D

## CAUTION

### LIQUIDS CAN DAMAGE THE ELECTRONICS OF THE TRANSMITTER!

Liquids entering the housing of the device can cause a short-circuit and damage the electronics.

- ▷ Keep all liquids away from the device.
  - ▷ Do not use any solvents or cleansing agents.
- 
- ▷ Before cleaning, disconnect the device from the mains.
  - ▷ Only use a soft and dry cloth to clean the device.

## If a problem occurs

Problem	Possible cause	Possible remedy
No operation indication on the transmitter	No mains connection	Check the mains unit and the connection to the DC IN socket (see page 11)
Audio signal is distorted	Transmitter sensitivity is adjusted too high	Change the sensitivity of the microphone input or line input (see page 17)
		Select the source of the input signal (see page 17)
Occasional drop outs in the audio signal	Distance to the transmitter is too great	Reduce the distance to the transmitter
	Interference of unknown origin	Set the transmitter and receiver to a different channel (see page 15)
	Interference is being received from a second transmitter	Change the transmitters to different channels (see page 15)
No radio waves on the receiver display	Antenna is badly positioned	Improve the position of the transmitting antenna: Mount the antenna to the front of the rack or use a remote antenna
	No RF signal: transmitter and receiver are not on the same channel	Set the transmitter and receiver to the same channel (see page 15)
	No RF signal: transmission range is exceeded	Reduce the distance between receiver and transmitter Improve the position of the transmitting antenna

If a problem occurs that is not listed in the above table or if the problem cannot be solved with the proposed solutions, please contact your local Sennheiser agent for assistance.

# Specifications

[SR 2020-D transmitter \(Art. No.: 500550\)](#)

[SR 2020-D-US transmitter \(Art. No.: 500551\)](#)

Modulation	2 FSK
Frequency range	863 – 865 MHz
Frequency range (US)	926 – 928 MHz
Channels	
tourguide mode	6 in parallel
conference mode	8 in parallel
Frequency response	100 – 7,000 Hz
Signal-to-noise-ration	> 70 dB(A)
THD	< 1 % (@ 1kHz)
Input voltage range	160 mV – 2.5 V (Mic), 2 mV – 125 mV (Line)
Phantom Powering	48 V
Power supply	12 V $\overline{=}$ (10,5 V – 16 V)
Current consumption	max. 300 mA
Temperature	0 – 50 °C
Range Indoor	up to 50 m
Range Outdoor	up to 100 m
Dimensions	212 x 145 x 38 mm
Weight	1100 g

## NT 2-3 CW mains unit

Input voltage	100 - 240 V~, 50 – 60 Hz
Current consumption	max. 120 mA
Output voltage	12 V $\overline{=}$
Output current	400 mA
Temperature	-10 °C – +55 °C (32 °F – +131 °F)
Weight	approx. 160 g

## Accessories

Product name	Product description	Art. No.
	Telescopic antenna	072817
	Device feet (4 pieces)	082875
HDE 2020-D-II-II	Stethoset receiver	504796
HDE 2020-D-II-II-US	Stethoset receiver (US)	504797
EK 2020-D-II	Receiver	504794
EK 2020-D-II-US	Receiver (US)	504795
GA 3030-AM	Antenna mount (2 transmitters)	004368
AM 2	Antenna mount for GA 2 rack adapter (1 transmitter)	009912
AC 3	Active transmitter combiner for 4 transmitters	503166
AC 3200-II	Active transmitter combiner for 8 transmitters	505497
A 2003-UHF	Remote antenna	003658
A 1031-U	Remote antenna	004645
NT 2-3-EU	Mains unit (EU)	503157
NT 2-3-US	Mains unit (US)	503870
NT 2-3-UK	Mains unit (UK)	503871





**Sennheiser electronic GmbH & Co. KG**

Am Labor 1, 30900 Wedemark, Germany, [www.sennheiser.com](http://www.sennheiser.com)  
Printed in Germany, Publ. 05/19, 583933/A01