

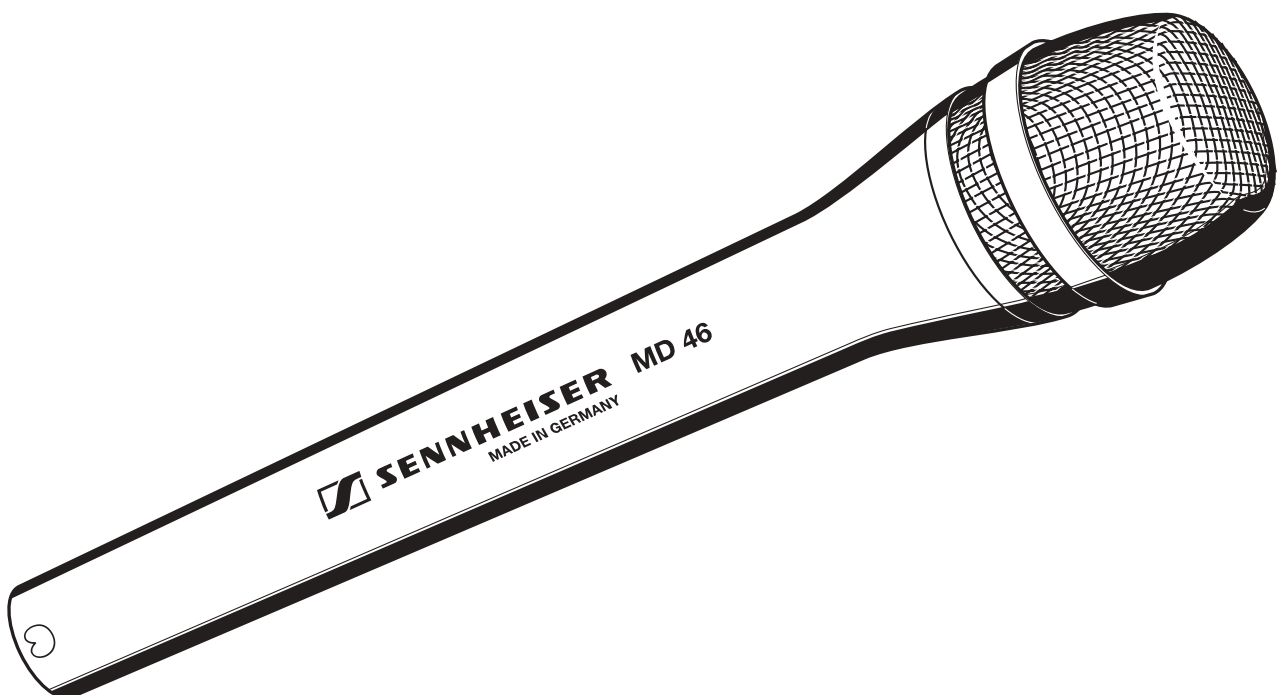

INSTRUCTIONS FOR USE

MD 46



MD 46 DYNAMIC MICROPHONE

High-quality hand-held microphone with cardioid pick-up pattern. Designed for rugged routine use in radio and TV reporting. Easy to handle - the special design minimizes wind and handling noise.

CHARACTERISTICS

- Excellent speech clarity due to optimised frequency response.
- Specially designed rugged housing for tough use.
- Good recording results.
- Excellent rejection of handling noise.
- Special protection against wind and pop noise due to double layer sound inlet basket.

RECOMMENDED ACCESSORIES (NOT SUPPLIED)

- Quick release clamp MZQ 800, Cat. No. 04711.
 - Foam windshield MZW 5000 (black), Cat. No. 03824.
 - Foam windshield MZW 65 PRO (black, velour), Cat. No. 03757.
- Other colours and imprints are available on request, please order from your local Sennheiser dealer.

TECHNICAL DATA

Acoustic principle	Pressure-gradient microphone
Frequency response	40 - 18,000 Hz
Pick-up pattern	Cardioid
Rejection at 1 kHz at 180°	20 dB
Sensitivity (free field, no load) at 1 kHz	2.0 mV/Pa \pm 2.5 dB (= -54 dBV with 0 dB = 1 V/Pa) (= -74 dBV with 0 dB = 1V/ μ bar;USA)
Nominal impedance at 1 kHz	350 Ω
Min. terminating impedance	1000 Ω
Magnetic field interference factor	\leq 1 μ V/ μ T
Connector	3-pin XLR connector
Dimensions / weight	\varnothing 49 mm, length 250 mm / approx. 360 g
Delivery includes	MD 46 microphone

Subject to alterations

NOMINAL FREQUENCY RESPONSE

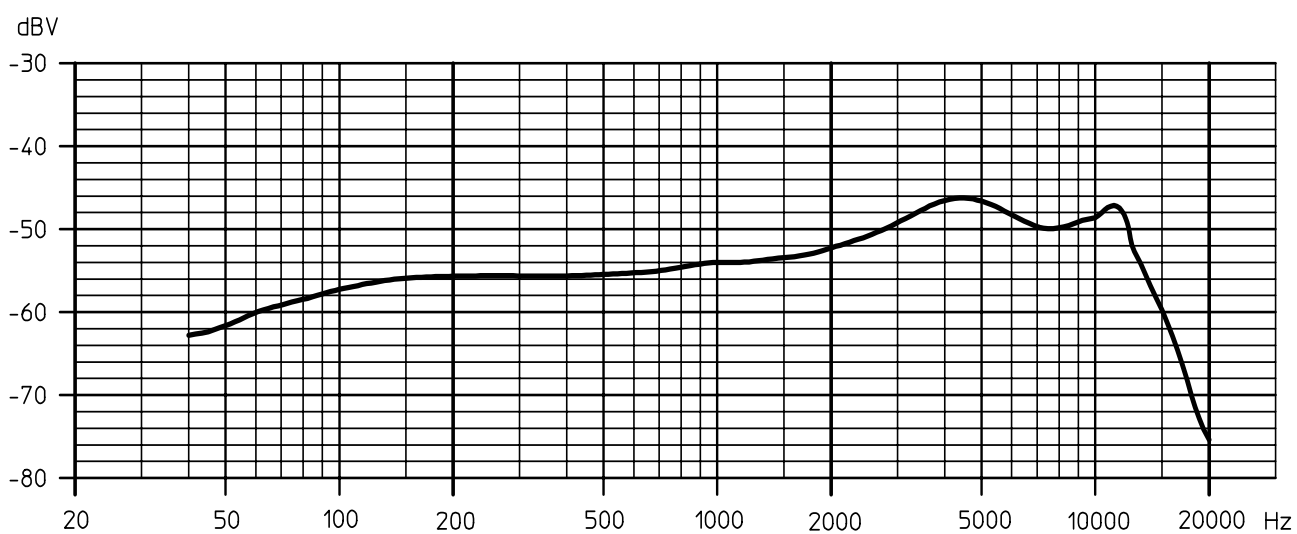

PICK-UP PATTERN

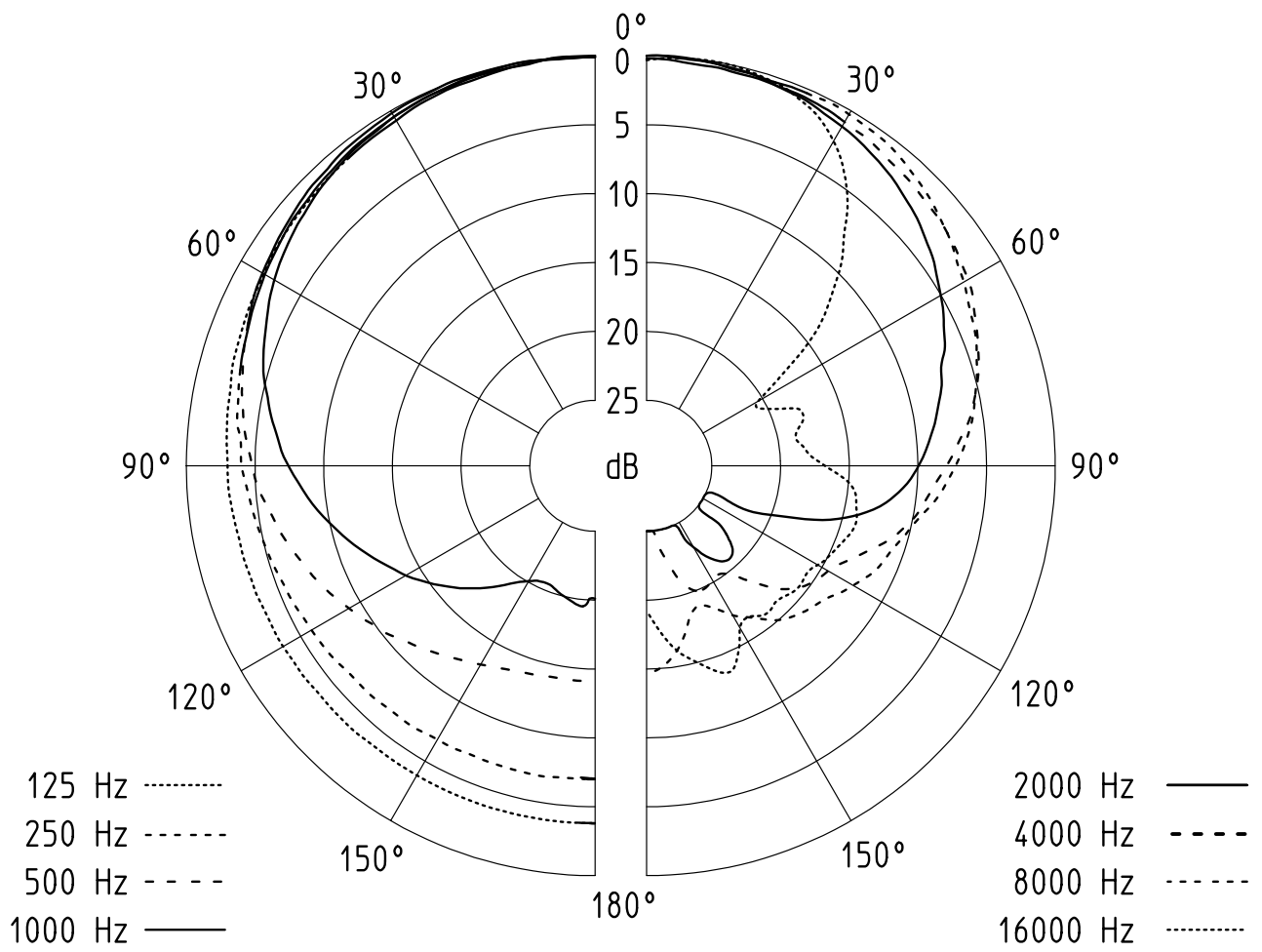

CONNECTION

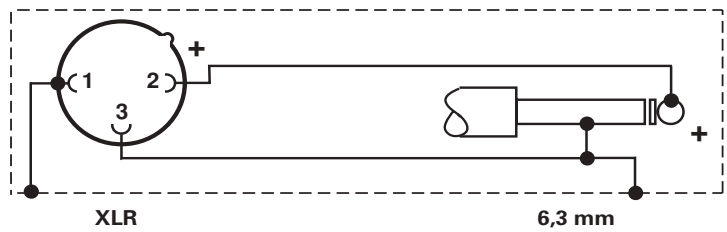
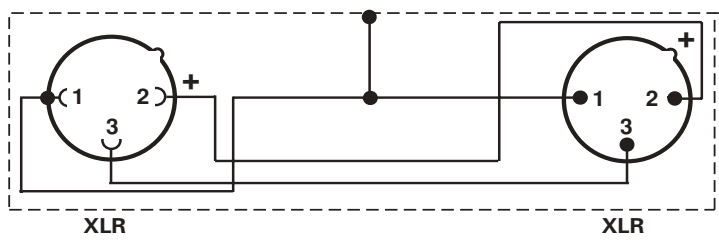
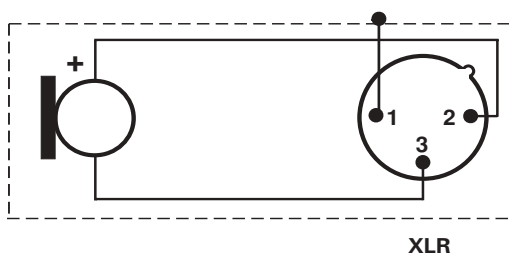
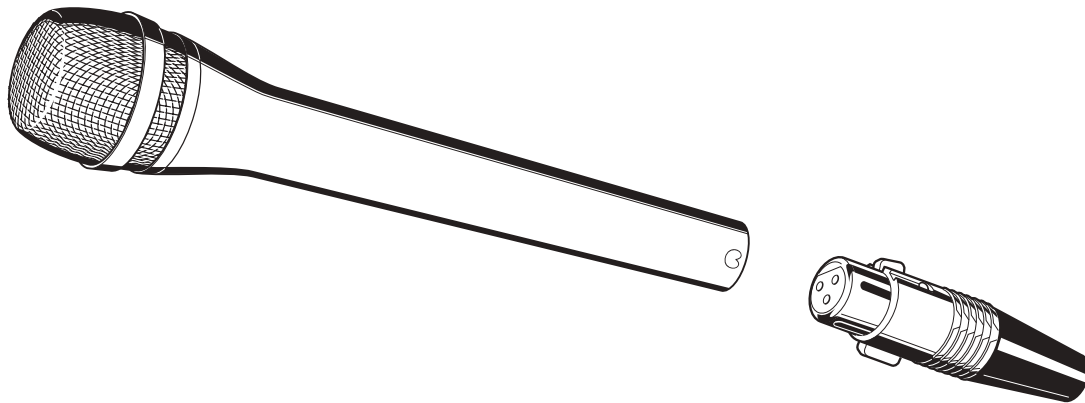



APPROVAL

Sennheiser electronic GmbH & Co. KG declare that this device is in compliance with the applicable CE standards and regulations.
Before putting this device into operation, please observe the respective country-specific regulations!



Sennheiser electronic GmbH & Co. KG
D-30900 Wedemark

Telefon 05130/600-0
Telefax 05130/600-300
www.sennheiser.com

Printed in Germany

Publ. 03/01

83522 / A01