

MX200 | Dual Reverb Effects Processor



User Guide

IMPORTANT SAFETY INSTRUCTIONS



WARNING: TO REDUCE THE RISK OF FIRE OR ELECTRIC SHOCK DO NOT EXPOSE THIS EQUIPMENT TO RAIN OR MOISTURE

ATTENTION: POUR RÉDUIRE LE RISQUE D'INCENDIE OU D'ÉLECTROCUTION N'EXPOSEZ PAS CET APPAREIL À LA PLUIE OU L'HUMIDITÉ

The symbols shown above are internationally accepted symbols that warn of potential hazards with electrical products. The lightning flash with arrowpoint in an equilateral triangle means that there are dangerous voltages present within the unit. The exclamation point in an equilateral triangle indicates that it is necessary for the user to refer to the owner's manual.

These symbols warn that there are no user serviceable parts inside the unit. Do not open the unit. Do not attempt to service the unit yourself. Refer all servicing to qualified personnel. Opening the chassis for any reason will void the manufacturer's warranty. Do not get the unit wet. If liquid is spilled on the unit, shut it off immediately and take it to a dealer for service. Disconnect the unit during storms to prevent damage.

The following is indicative of low altitude use; do not use this product above 2000m.



U.K. MAINS PLUG WARNING

A molded mains plug that has been cut off from the cord is unsafe. Discard the mains plug at a suitable disposal facility.

NEVER UNDER ANY CIRCUMSTANCES SHOULD YOU INSERT A DAMAGED OR CUT MAINS PLUG INTO A 13 AMP POWER SOCKET.

Do not use the mains plug without the fuse cover in place. Replacement fuse covers can be obtained from your local retailer. Replacement fuses are 13 amps and **MUST** be ASTA approved to BS1362.



If you want to dispose this product, do not mix it with general household waste. There is a separate collection system for used electronic products in accordance with legislation that requires proper treatment, recovery and recycling.

Private households in the 25 member states of the EU, in Switzerland and Norway may return their used electronic products free of charge to designated collection facilities or to a retailer (if you purchase a similar new one).

For Countries not mentioned above, please contact your local authorities for a correct method of disposal.

By doing so you will ensure that your disposed product undergoes the necessary treatment, recovery and recycling and thus prevent potential negative effects on the environment and human health.

WARNING FOR YOUR PROTECTION READ THE FOLLOWING:

READ THESE INSTRUCTIONS.

KEEP THESE INSTRUCTIONS.

HEED ALL WARNINGS.

FOLLOW ALL INSTRUCTIONS.

DO NOT USE THIS APPARATUS NEAR WATER.

CLEAN ONLY WITH A DRY CLOTH.

FOR INDOOR USE ONLY.

DO NOT BLOCK ANY OF THE VENTILATION OPENINGS. INSTALL IN ACCORDANCE WITH THE MANUFACTURER'S INSTRUCTIONS.

DO NOT INSTALL NEAR ANY HEAT SOURCES SUCH AS RADIATORS, HEAT REGISTERS, STOVES, OR OTHER APPARATUS (INCLUDING AMPLIFIERS) THAT PRODUCE HEAT.

ONLY USE ATTACHMENTS/ACCESSORIES SPECIFIED BY THE MANUFACTURER.

UNPLUG THIS APPARATUS DURING LIGHTNING STORMS OR WHEN UNUSED FOR LONG PERIODS OF TIME.

Do not defeat the safety purpose of the polarized or grounding-type plug. A polarized plug has two blades with one wider than the other. A grounding type plug has two blades and a third grounding prong. The wide blade or third prong are provided for your safety. If the provided plug does not fit your outlet, consult an electrician for replacement of the obsolete outlet.

Protect the power cord from being walked on or pinched particularly at plugs, convenience receptacles, and the point where they exit from the apparatus.

Use only with the cart stand, tripod bracket, or table specified by the manufacture, or sold with the apparatus. When a cart is used, use caution when moving the cart/apparatus combination to avoid injury from tip-over.



Refer all servicing to qualified service personnel. Servicing is required when the apparatus has been damaged in any way, such as power-supply cord or plug is damaged, liquid has been spilled or objects have fallen into the apparatus, the apparatus has been exposed to rain or moisture, does not operate normally, or has been dropped.

POWER ON/OFF SWITCH: The Power switch used in this piece of equipment DOES NOT break the connection from the mains.

MAINS DISCONNECT: The plug shall remain readily operable. For rack-mount or installation where plug is not accessible, an all-pole mains switch with a contact separation of at least 3 mm in each pole shall be incorporated into the electrical installation of the rack or building.

If connected to 240V supply, a suitable CSA/UL certified power cord shall be used for this supply.

This Equipment is intended for rack mount use only.

IMPORTANT SAFETY INSTRUCTIONS

ELECTROMAGNETIC COMPATIBILITY

This device complies with part 15 of the FCC Rules and the Product Specifications noted on the **Declaration of Conformity**. Operation is subject to the following two conditions:

- this device may not cause harmful interference, and
- this device must accept any interference received, including interference that may cause undesired operation.

Operation of this unit within significant electromagnetic fields should be avoided.

- use only shielded interconnecting cables.

SAFETY INSTRUCTIONS

NOTICE FOR CUSTOMERS IF YOUR UNIT IS EQUIPPED WITH A POWER CORD.

WARNING: THIS APPLIANCE SHALL BE CONNECTED TO A MAINS SOCKET OUTLET WITH A PROTECTIVE EARTHING CONNECTION.

THE CORES IN THE MAINS LEAD ARE COLOURED IN ACCORDANCE WITH THE FOLLOWING CODE:

GREEN AND YELLOW - EARTH BLUE - NEUTRAL BROWN - LIVE

AS COLOURS OF THE CORES IN THE MAINS LEAD OF THIS APPLIANCE MAY NOT CORRESPOND WITH THE COLOURED MARKINGS IDENTIFYING THE TERMINALS IN YOUR PLUG, PROCEED AS FOLLOWS:

- THE CORE WHICH IS COLOURED GREEN AND YELLOW MUST BE CONNECTED TO THE TERMINAL IN THE PLUG MARKED WITH THE LETTER E, OR WITH THE EARTH SYMBOL, OR COLOURED GREEN, OR GREEN AND YELLOW.
- THE CORE WHICH IS COLOURED BLUE MUST BE CONNECTED TO THE TERMINAL MARKED N OR COLOURED BLACK.
- THE CORE WHICH IS COLOURED BROWN MUST BE CONNECTED TO THE TERMINAL MARKED L OR COLOURED RED.

THIS EQUIPMENT MAY REQUIRE THE USE OF A DIFFERENT LINE CORD, ATTACHMENT PLUG, OR BOTH, DEPENDING ON THE AVAILABLE POWER SOURCE AT INSTALLATION. IF THE ATTACHMENT PLUG NEEDS TO BE CHANGED, REFER SERVICING TO QUALIFIED SERVICE PERSONNEL WHO SHOULD REFER TO THE TABLE BELOW. THE GREEN/YELLOW WIRE SHALL BE CONNECTED DIRECTLY TO THE UNITS CHASSIS.

CONDUCTOR		WIRE COLOR	
		Normal	Alt
L	LIVE	BROWN	BLACK
N	NEUTRAL	BLUE	WHITE
E	EARTH GND	GREEN/YEL	GREEN

WARNING: IF THE GROUND IS DEFEATED, CERTAIN FAULT CONDITIONS IN THE UNIT OR IN THE SYSTEM TO WHICH IT IS CONNECTED CAN RESULT IN FULL LINE VOLTAGE BETWEEN CHASSIS AND EARTH GROUND. SEVERE INJURY OR DEATH CAN THEN RESULT IF THE CHASSIS AND EARTH GROUND ARE TOUCHED SIMULTANEOUSLY.

WARNING:

- APPARATET MÅ TILKOPLES JORDET STIKKONTAKT.
- APPARATEN SKALL ANSLUTAS TILL JORDAT UTTAG.
- LAITE ON LIITETTÄVÄ SUOJAKOSKETTIMILLA VARUSTETTUUN PISTORASIAAN.
- APPARATET SKAL TILSLUTTES JORDET STIKKONTAKT.

DECLARATION OF CONFORMITY

Manufacturer's Name: Lexicon Professional
Manufacturer's Address: 10653 S. River Front Parkway, Suite 300
South Jordan, Utah 84095, USA

declares that the product:

Product name: Lexicon MX200
Note: Product name may be suffixed by a combination of the letters EU, M, or V.

Product option: None

conforms to the following Product Specifications:

Safety: IEC 60065-01+Amd 1 & 2

EMC: EN 55022:2010
EN 55024:2010
FCC Part 15

Supplementary Information:

The product herewith complies with the requirements of the:
Low Voltage Directive 2014/35/EU
EMC Directive 2014/30/EU
RoHS Directive 2011/65/EU
WEEE Directive 2012/19/EU

With regard to Directive 2005/32/EC and EC Regulation 1275/2008 of 17 December 2008, this product is designed, produced, and classified as Professional Audio Equipment and thus is exempt from this Directive.

C. Rex Reed
Director, Engineering
Signal Processing
10653 S. River Front Parkway, Suite 300
South Jordan, Utah 84095, USA
Date: August 15, 2016

European Contact:

Harman International
Salisbury House
London Wall
EC2M 5QQ
+44 207 562 9450

or

Harman Professional Inc.
10653 S. River Front Parkway, Suite 300
South Jordan, Utah 84095, USA
Ph: (801) 566-8800
Fax: (801) 568-7583

CONSIGNES DE SÉCURITÉ IMPORTANTES



WARNING: TO REDUCE THE RISK OF FIRE OR ELECTRIC SHOCK DO NOT EXPOSE THIS EQUIPMENT TO RAIN OR MOISTURE

ATTENTION: POUR RÉDUIRE LE RISQUE D'INCENDIE OU D'ÉLECTROCUTION N'EXPOSEZ PAS CET APPAREIL À LA PLUIE OU L'HUMIDITÉ

Les symboles illustrés ci-dessus sont des symboles acceptés internationalement qui avertissent des dangers potentiels relatifs à l'utilisation de produits électriques. Le voyant clignotant avec une flèche dans un triangle équilatéral signifie la présence de tensions dangereuses dans l'appareil. Le point d'exclamation dans un triangle équilatéral indique que l'utilisateur doit se référer au manuel d'utilisation.

Ces symboles indiquent qu'il n'y a aucune pièce utilisable par l'utilisateur à l'intérieur de l'appareil. Ne pas ouvrir l'appareil. Ne pas essayer de réparer soi-même l'appareil. Confier toute réparation à du personnel qualifié. Ouvrir la structure de l'appareil pour quelque raison que ce soit annule la garantie du fabricant. Ne pas mouiller l'appareil. Si du liquide est renversé sur l'appareil, fermer immédiatement l'appareil et l'apporter chez un réparateur. Débrancher l'appareil pendant les tempêtes afin d'éviter des dommages.

Ce qui suit est représentatif d'une utilisation à basse altitude ; ne pas utiliser ce produit au-dessus de 2000 m.



AVERTISSEMENT CONCERNANT LA FICHE SECTEUR

Une fiche secteur moulée qui a été coupée du cordon est dangereuse. Jeter la fiche secteur dans un centre de déchets adapté.

VOUS NE DEVEZ EN AUCUNE CIRCONSTANCE INSÉRER UNE FICHE ENDOMMAGÉE OU COUPÉE DANS UNE PRISE SECTEUR 13 AMP.

Ne pas utiliser la fiche secteur si le couvercle du coffret à fusibles n'est pas bien en place. Vous pouvez vous procurer des capots de fusible de rechange auprès de votre détaillant local. Les fusibles de remplacement sont de 13 A et DOIVENT être approuvés ASTA, BS1362.



Ne pas jeter ce produit avec les ordures ménagères. Il existe un système de collecte sélective pour les produits électroniques usagés en conformité avec les lois en vigueur en matière de traitement, de récupération et de recyclage.

Dans les 25 États membres de l'UE, en Norvège et en Suisse, les ménages peuvent envoyer leurs produits électroniques usagés sans frais vers des centres de collecte sélective ou chez un distributeur (contre l'achat d'un nouveau produit).

Contactez les autorités locales pour connaître les procédures de traitement des déchets adaptées dans les pays non mentionnés ci-dessus.

Non seulement cette précaution vous permettra d'être sûr que votre produit est correctement traité, récupéré et recyclé, mais elle vous évitera également de nuire involontairement à l'environnement et à la santé humaine.

AVERTISSEMENT POUR VOTRE SÉCURITÉ LIRE ATTENTIVEMENT :

LIRE CES CONSIGNES.

CONSERVER CES CONSIGNES.

RESPECTER TOUS LES AVERTISSEMENTS.

SUIVRE TOUTES LES CONSIGNES.

NE PAS UTILISER CET APPAREIL PRÈS DE L'EAU.

NETTOYER UNIQUEMENT AVEC UN CHIFFON SEC.

POUR USAGE INTÉRIEUR UNIQUEMENT.

NE PAS OBSTRUER LES OUÏES D'AÉRATION. EFFECTUER L'INSTALLATION CONFORMÉMENT AUX INSTRUCTIONS DU FABRICANT.

NE PAS INSTALLER À PROXIMITÉ DE SOURCES DE CHALEUR TELLES QUE DES RADIATEURS, BOUCHES D'AÉRATION, PLAQUES CHAUFFANTES OU TOUT AUTRE APPAREIL (Y COMPRIS DES AMPLIFICATEURS) DÉGAGEANT DE LA CHALEUR.

UTILISER UNIQUEMENT LES PIÈCES/ACCESSOIRES MENTIONNÉS PAR LE FABRICANT.

DÉBRANCHER L'APPAREIL AU COURS DES ORAGES OU EN CAS DE NON-UTILISATION PENDANT UNE DURÉE PROLONGÉE.

Ne pas détériorer la sécurité de la fiche polarisée ou de la fiche de terre. Les fiches polarisées sont équipées de deux bornes de largeurs différentes. Les fiches de terre comportent deux lames et une troisième broche de mise à la terre. La broche la plus large ou troisième broche de mise à la terre est prévue pour votre sécurité. Si la fiche fournie ne correspond pas à votre installation électrique, faire appel à un électricien pour remplacer la prise hors normes.

Protéger le cordon d'alimentation contre les risques de piétinement ou de pincement, notamment au niveau des fiches, des prises de courant et du point d'attache avec le matériel.

Utiliser uniquement le chariot, le support, le trépied ou la table spécifié(e) par le fabricant ou vendu(e) avec le matériel. Si vous utilisez un chariot pour déplacer l'appareil, soyez suffisamment prudent pour éviter une éventuelle blessure consécutive au basculement du chariot et de sa charge.



Les réparations doivent être confiées à un technicien S.A.V. qualifié. Une réparation est nécessaire en cas de dommage quelconque et en particulier en cas d'endommagement du cordon d'alimentation ou de la fiche électrique, d'infiltration liquide, d'introduction involontaire d'un objet dans l'appareil, d'exposition de l'appareil à la pluie ou à un milieu humide, de fonctionnement anormal ou de chute de l'appareil.

INTERRUPTEUR MARCHÉ/ARRÊT : l'interrupteur d'alimentation de cet équipement NE coupe PAS la connexion secteur.

DÉBRANCHEMENT DE L'APPAREIL : la prise de courant doit rester facilement accessible. Pour un montage en rack ou une installation avec une prise inaccessible, un interrupteur omnipolaire à distance d'ouverture de contact d'au moins 3 mm doit être intégré à l'installation électrique du rack ou du local.

Si le matériel est relié à une alimentation de 240 V, utiliser impérativement un cordon d'alimentation adapté certifié CSA/UL pour ce branchement.

Cet équipement est exclusivement destiné à un montage en rack.

CONSIGNES DE SÉCURITÉ IMPORTANTES

COMPATIBILITÉ ÉLECTROMAGNÉTIQUE

Cet appareil est conforme au volet 15 des règles du FCC et aux spécifications techniques évoquées dans la **Déclaration de conformité**. Son fonctionnement est soumis aux deux conditions suivantes :

- cet appareil ne doit pas causer d'interférences nuisibles et
- cet appareil doit accepter les interférences captées, y compris les interférences susceptibles de nuire à son fonctionnement.

L'utilisation de cet appareil à proximité de champs électromagnétiques puissants n'est pas recommandée.

- utiliser exclusivement des câbles d'interconnexion blindés.

CONSIGNES DE SÉCURITÉ

NOTICE ADRESSÉE AUX CONSOMMATEURS ÉQUIPÉS D'UN MATÉRIEL AVEC CORDON D'ALIMENTATION FOURNI.

AVERTISSEMENT : CET APPAREIL DOIT ÊTRE BRANCHÉ SUR UNE PRISE SECTEUR DOTÉE D'UNE PROTECTION PAR MISE À LA TERRE.

LES COULEURS DES NOYAUX DANS LES FILS SECTEURS DOIVENT RESPECTER LES CODES SUIVANTS :

VERT ET JAUNE - TERRE BLEU - NEUTRE MARRON - PHASE

LES COULEURS DES NOYAUX DANS LES FILS SECTEURS DE CET APPAREIL PEUVENT NE PAS CORRESPONDRE AUX INSCRIPTIONS COLORÉES IDENTIFIANT LES TERMINAUX DANS VOTRE FICHE ; IL FAUT DONC PROCÉDER DE LA FAÇON SUIVANTE :

- LE NOYAU VERT ET JAUNE DOIT ÊTRE BRANCHÉ AU TERMINAL DE LA FICHE OÙ APPARAÎT LA LETTRE E OU LE SYMBOLE DE MISE À LA TERRE, OU AU TERMINAL VERT OU VERT ET JAUNE.
- LE NOYAU BLEU DOIT ÊTRE BRANCHÉ AU TERMINAL MARQUÉ D'UN N OU DE COULEUR NOIRE.
- LE NOYAU MARRON DOIT ÊTRE BRANCHÉ AU TERMINAL MARQUÉ D'UN L OU DE COULEUR ROUGE.

CE MATÉRIEL PEUT NéCESSITER L'UTILISATION D'UN CORDON D'ALIMENTATION DIFFÉRENT ET/OU D'UNE FICHE DE BRANCHEMENT DIFFÉRENTE SELON LA SOURCE D'ALIMENTATION DISPONIBLE À L'INSTALLATION. SI LA FICHE DE BRANCHEMENT DOIT ÊTRE CHANGÉE, FAIRE APPEL À UN TECHNICIEN QUALIFIÉ QUI DEVRA SE RÉFÉRER AU TABLEAU CI-DESSOUS. LE FIL VERT/JAUNE DOIT ÊTRE BRANCHÉ DIRECTEMENT AU CHÂSSIS DE L'APPAREIL.

CONNECTEURS		COULEUR DU FIL	
		Normal	Alt
L	PHASE	MARRON	NOIR
N	NEUTRE	BLEU	BLANC
E	TERRE	VERT/JAU	VERT

ATTENTION : UN DÉFAUT DE MISE À LA TERRE PEUT PROVOQUER CERTAINS DYSFONCTIONNEMENTS DE L'APPAREIL OU DU SYSTÈME AUQUEL IL EST RELIÉ, POUVANT SE TRADUIRE PAR UNE TENSION COMPOSÉE ENTRE LA MASSE ET LA PRISE DE TERRE. CELA PEUT PROVOQUER DES BLESSURES SÉRIEUSES OU FATALES SI LA MASSE ET LA PRISE DE TERRE SONT TOUCHÉES EN MÊME TEMPS.

ATTENTION :

- APPARATET MÅ TILKOPLES JORDET STIKKONTAKT.
- APPARATEN SKALL ANSLUTAS TILL JORDAT UTTAG.
- LAITE ON LIITETTÄVÄ SUOJAKOSKETTIMILLA VARUSTETTUUN PISTORASIAAN.
- APPARATET SKAL TILSLUTTES JORDET STIKKONTAKT.

DÉCLARATION DE CONFORMITÉ

Nom du fabricant : Lexicon Professional
Adresse du fabricant : 10653 S. River Front Parkway, Suite 300
South Jordan, Utah 84095, ÉTATS-UNIS

déclare que le produit :

Nom du produit : Lexicon MX200
Remarque : Nom du produit peut être suffixé par une combinaison des lettres de l'UE, M ou V.

Option du produit : Aucune

est conforme aux spécifications suivantes :

Sécurité : CEI/IEC 60065:2001 + Amd 1 et 2

CEM : EN 55022:2010
EN 55024:2010
Partie 15 des FCC

Informations complémentaires :

Ce produit est conforme aux exigences suivantes :

Directive sur la basse tension 2014/35/UE
Directive 2014/30/UE
Directive RoHS 2011/65/UE
Directive DEEE 2012/19/UE

Ce produit appartenant à la catégorie Matériel audio professionnel, il n'est pas concerné par la directive 2005/32/CE ou par le règlement européen 1275/2008 du 17 décembre 2008.

C. Rex Reed
Directeur, Ingénierie
Traitement des signaux
10653 S. River Front Parkway, Suite 300
South Jordan, Utah 84095, ÉTATS-UNIS
Date : 15 août 2016

Contactez européenne :

Harman International
Salisbury House
London Wall
EC2M 5QQ
+44 207 562 9450

ou

Harman Professional Inc
10653 S. River Front Parkway, Suite 300
South Jordan, Utah 84095, ÉTATS-UNIS
Tél. : (801) 566-8800
Fax : (801) 568-7583

Warranty

Warranty

This warranty is valid only for the original purchaser and only in the United States.

1. The warranty registration card that accompanies this product must be mailed within 30 days after purchase date to validate this warranty. Proof-of-purchase is considered to be the burden of the consumer.
2. Lexicon Professional warrants this product, when bought and used solely within the U.S., to be free from defects in materials and workmanship under normal use and service.
3. Lexicon Professional's liability under this warranty is limited to repairing or, at our discretion, replacing defective materials that show evidence of defect, provided the product is returned to Lexicon professional WITH RETURN AUTHORIZATION from the factory, where all parts and labor will be covered up to a period of 1 year. A Return Authorization number must be obtained from Lexicon Professional by telephone. The company shall not be liable for any consequential damage as a result of the product's use in any circuit or assembly.
4. Lexicon Professional reserves the right to make changes in design or make additions to or improvements upon this product without incurring any obligation to install the same additions or improvements on products previously manufactured.
5. The foregoing is in lieu of all other warranties, expressed or implied, and Lexicon Professional neither assumes nor authorizes any person to assume on its behalf any obligation or liability in connection with the sale of this product. In no event shall Lexicon Professional or its dealers be liable for special or consequential damages or from any delay in the performance of this warranty due to causes beyond its control.

Table of Contents

Quick Start	1	The MX-Edit Editor/Librarian - Mac	32
About the MX200	3	Minimum System Requirements	32
Overview.....	3	Installing the MX-Edit Editor/Librarian.....	32
Diagram - Front Panel.....	4	Quick Start.....	32
Diagram - Rear Panel	6	The MX-Edit Program Window.....	32
Setup.....	7	Editing a Program.....	33
Connecting the MX200.....	7	Quick Access Menu.....	34
Using the MX200.....	10	Using the MX200 as a Hardware Plug-In.....	35
Loading Programs	10	Minimum System Requirements	35
Editing Programs.....	10	Installing the MX-Edit VST Hardware Plug-In	35
Selecting Effects.....	10	Connecting the MX200.....	35
Tap Tempo	11	Software Configuration.....	36
The Audition Feature.....	11	Using the MX200 Plug-In Window	36
Routing Options.....	12	Controls	36
Storing Programs.....	12	MIDI Port Error Message.....	37
Effects Descriptions.....	13	Using MIDI with the MX200.....	37
Reverbs	13	CC Mapping.....	37
Delays.....	17	MIDI Implementation Chart	37
dbx® Dynamics	19	Specifications	38
Modulated Effects.....	20	Appendix	39
MX200 Utilities	23	Program List	40
MIDI Channel.....	23		
Program AutoLoad	23		
Analog / Digital Input Select.....	23		
Digital Out Dry Track.....	24		
Stereo and Mono Output Modes.....	24		
Factory Program Banks: Serial and Parallel	24		
Bypass Mode Select.....	25		
Factory Reset.....	25		
The MX-Edit Editor/Librarian - Windows.....	26		
Minimum System Requirements	26		
Installing the MX-Edit Editor/Librarian Software.....	26		
Quick Start.....	26		
The MX-Edit Library	27		
Opening or Creating a Program.....	27		
The MX-Edit Program Editor	28		
Editing a Program.....	28		
Saving a Program.....	30		
Storing a Program	30		
Archiving.....	30		

Quick Start

Ideally, you should read this entire manual before using the MX200. But, if you just can't wait to get started, this section explains how to set up a simple parallel connection (using the MX200 with a mixer) and select a program.

Powering the Unit

1. Plug the included power supply into an A/C outlet.
2. Connect the Power Supply to the **Power Jack** connection on the MX200's back panel.



3. When the MX200 first powers up, the **Audition** button quickly flashes for a moment. This indicates that the software is loading.

Standard Parallel Connection

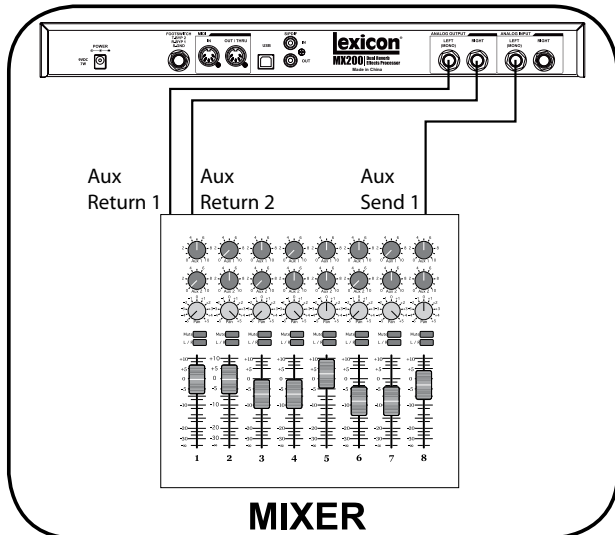

1. Connect the mixer's Post Fader Aux Send output to the MX200's **Left** (Mono) input.
2. Connect the MX200 **Left** and **Right** outputs to a stereo Aux Return input on the mixer (or a stereo line input, or two adjacent line inputs if you like).

Set Audio Levels

1. Set the gain on the mixer's input channel appropriate to the source (vocal mic, guitar, keyboard, etc.).
2. Set the Aux Master level (if provided on your console) to the 12 o'clock position.
3. Set the **Input** level on the MX200 to the 12 o'clock position.
4. Set the **Mix 1** and **Mix 2** knobs on the MX200 to their full clockwise position. (Wet).
5. Provide source signal (by speaking or singing into the mic, playing guitar, keyboard, etc.) on the selected mixer channel.
6. Turn up the Aux Send level on the channel corresponding to the Post-fader send (Aux 1 in this example) that the MX200 is connected to until the Red Input LEDs light only occasionally. If the red Input LEDs stay lit, too much signal is being sent to the MX200; reduce the Aux Master or Aux Send on the mixer.
7. Turn up the Aux Return to the 12 o'clock position, or stereo line input faders to the 0dB position, if you used that connection.
8. To increase or decrease the amount of effect on the signal, adjust the Aux Send level on the channel that you want affected.

Select and Load a Program

Turn the **Program Select** knob to choose a program. The display flashes the number of the program to be loaded. Press the knob to load the program.



Note that the MX200 comes with 99 Factory programs and 99 User programs. A small dot appears at the bottom right of the **Program Display** window, indicating that the displayed program is a User program. For more information about editing programs, see page 10.

Audition the Effect

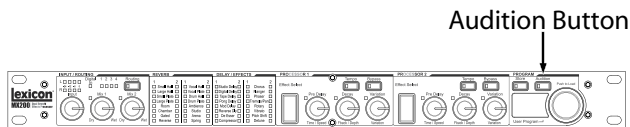

The **Audition** button allows you to preview the loaded program by playing short digital samples through the effect processors. There are five audio samples included in the MX200, including various drum sounds, vocal, and guitar. In the factory setting, tapping the **Audition** button cycles through the five sounds, but you may want to repeat a particular sound as you choose or edit an effect. See page 11 for more information.

About the MX200

Overview

The MX200 is a dual-processor, single rack space multi-effects device designed with both live sound reinforcement and home recording in mind. Featuring the deep, rich reverb algorithms that built the Lexicon® legend, the MX200 offers increased versatility with dynamics and specialty effects—all instantly accessible via the extremely intuitive front panel.

Either way you use the MX200 – live or in the studio – you can choose two effects at once in one of four routing schemes: Dual Stereo (Parallel), Cascade (Serial), Mono Split or Dual Mono. The MX200 has 99 carefully crafted Factory programs, and 99 User programs that allow you to create your own custom effect settings. Front panel controls include **Input Level**, **Mix 1** and **Mix 2** controls, effects **Routing** button, independent **Tempo** and **Bypass** buttons, three **Parameter** knobs for each Processor, **Program Select** knob, an **Audition** button, and a **Store** button.

Studio Operation

The MX200 features a USB interface that lets it function as a “hardware plug-in” – recognized and functioning within a VST™ or Audio Units compatible recording application as a plug-in effect, but still operating as a dedicated hardware processor. This unique hardware plug-in feature lets you add legendary Lexicon effects to your computer-based recordings with full automation and recall features via an intuitive cross-platform plug-in window without overburdening your CPU.

Live Operation

Those using the MX200 in live applications will appreciate its intuitive front panel layout. The **Active Reverb/Effects Matrix** displays which two of the 32 available reverbs and effects are active, and all editing functions require only a single button push or turn of a knob. Dual independent processor control areas feature dedicated **Effects Select**, **Tempo**, and **Bypass** buttons plus three **Parameter** knobs that provide instant access and control over the most critical parameters for the selected effect. Parameter change LEDs illuminate to indicate any changes to the 99 Factory or User programs. The **Audition** button plays one of five digitally recorded audio samples through the selected effects to audition their settings without the need for an external audio source.

Diagram - Front Panel

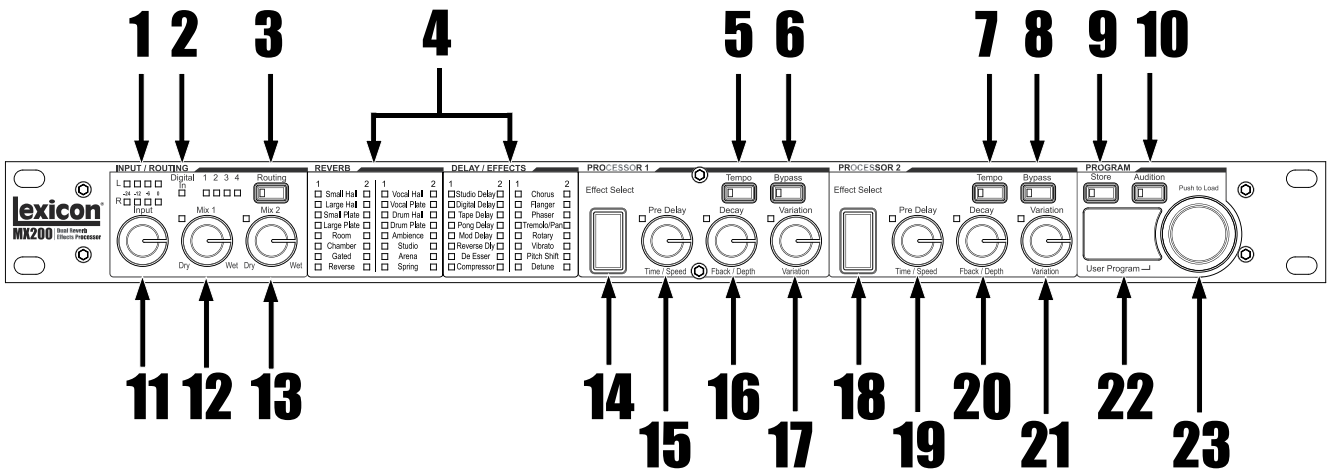

1. Dual Input Bargraph Meters
LEDs indicate input level for each channel.

2. Digital In LED
Indicates when the S/PDIF digital input is selected and active.

3. Routing Button
Press this button to cycle through the four signal routing options. For more information about routing, see page 12.

4. Active Reverb / Effects Matrix
Indicates which effects are active at all times. Green LED indicates active effect in Processor 1, red LED indicates active effect in Processor 2.

5. Tempo Button - P1
Tapping this button twice sets the Delay Time of Processor 1. LED flashes to indicate current tempo, or lights solid when synced to MIDI.

6. Bypass Button - P1
Bypasses Processor 1. In the factory default, this puts the processor into Bypass mode and allows dry, unprocessed signal to pass through to the outputs. To change to Bypass Mute, which allows no signal (wet or dry) to pass, see Bypass Mode Select in the Utilities section on page 25.

7. Tempo Button - P2
Same as for Processor 1 (see #5).

8. Bypass Button - P2
Bypasses Processor 2. Red LED lights to indicate effect is bypassed.

9. Store Button
Stores program modifications to one of the 99 User program locations. Press the **Store** and **Audition** buttons simultaneously to access Utility functions. (See page 23 for more information.)

10. Audition Button
Plays audio samples through the processors to audition their settings. Press the **Audition** and **Store** buttons simultaneously to access the Utility functions. (See page 23 for more information.)

11. Input Knob
Controls the input level of both Left and Right analog inputs.

12. Mix 1 Knob
Controls the P1 Wet/Dry effects mix.

13. Mix 2 Knob
Controls the P2 Wet/Dry effects mix.

*Refer to the Effects Descriptions section for more information about parameters.

Diagram - Front Panel

14. Effect Select - P1

This button selects the reverb, delay, or effect to be loaded in Processor 1.

15. Pre Delay Knob - P1

Controls Pre Delay of the reverbs or the first parameter of the selected delay or effect in Processor 1.*

16. Decay Knob - P1

Controls Decay of the reverbs or the second parameter of the selected delay or effect in Processor 1.*

17. Variation - P1

Controls Liveliness or Diffusion (depending on the reverb selected) or the third parameter of the selected effect in Processor 1.*

18. Effect Select - P2

Same as for Processor 1 (see #14).

19. Pre Delay Knob - P2

Same as for Processor 1 (see #15).

20. Decay Knob - P2

Same as for Processor 1 (see #16).

21. Variation - P2

Same as for Processor 1 (see #17).

22. Program Display

2-character LED display indicates which of the 99 Factory or User programs is loaded. A small dot appears at the bottom right of the Program Display window, indicating that the displayed program is a User program. Also shows Utility settings and parameter values during editing.

23. Program Select Knob

Navigates through Factory and User programs, as well as Utility functions.

*Refer to the Effects Descriptions section for more information about parameters.

Diagram - Rear Panel

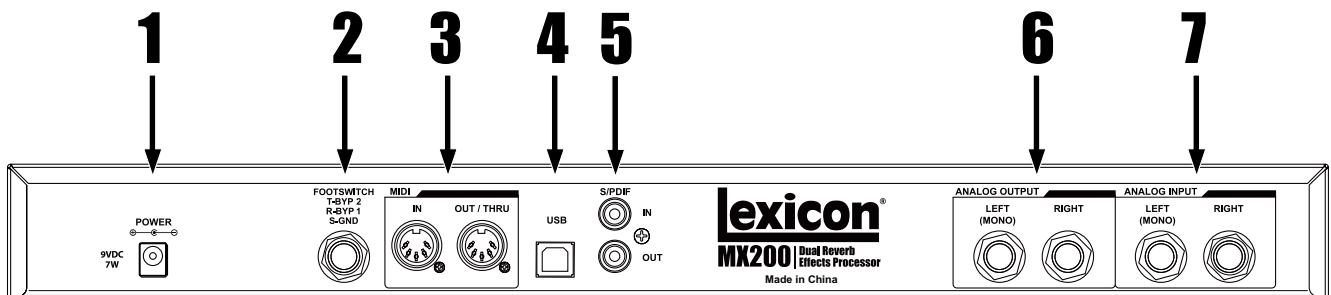

1. Power Jack

Connect only the included Harman Pro PS0913DC power supply here.

2. Footswitch Input

An optional 2-button footswitch can be plugged into this TRS jack for independent Bypass control of P1 and P2. Use the Lexicon® LEX-DFS or a 2-button footswitch wired as follows:

Tip = Bypass 2
 Ring = Bypass 1
 Sleeve = Ground

3. MIDI In, Out/Thru

Provides MIDI operation capabilities. Two 5-pin MIDI DIN connectors are available for MIDI IN and MIDI OUT/THRU. (See page 37 for MIDI Implementation chart.)

4. USB Port

Provides communication with a computer for use with MX-Edit™ software and MX200 plug-in window using a standard USB cable. When the MX200 is connected to a computer via USB, *U5* briefly appears in the **Program Display** window.

5. S/PDIF Digital In/Out

Digital input accepts 44.1kHz / 48kHz signals. When the S/PDIF digital input is selected and active, the **Digital In** LED on the front panel lights.

Important: It is recommended that you do not connect any digital device to the MX200's S/PDIF input that transmits at any other sample rate (such as 96kHz). Doing so can cause unpredictable performance. Make sure the device you are connecting to the MX200's **S/PDIF In** is set as the Clock Master (if that option is available) and transmitting at a sample rate of 44.1kHz or 48kHz only. As with any other connection, if you need to unplug the S/PDIF cable, it is recommended that you switch to the analog inputs (see **Digital Input Select** in the Utility section) or bypass both processors before disconnecting the cable.

6. Balanced Analog Line Outputs

Left and **Right** RF-filtered 1/4" balanced/unbalanced TRS line outputs are servo-balanced, so no signal loss is incurred when using unbalanced connections. To use the **Left** output as a mono sum of both **Left** and **Right** signals, refer to the **Stereo/Mono Output Mode Utility** section on page 24.

7. Balanced Analog Line Inputs

Left and **Right** active analog 1/4" TRS balanced/unbalanced line inputs. If only a single plug is connected to the **Left** input, the signal is split and sent to both the **Left** and **Right** input paths.

Setup

Connecting the MX200

Parallel vs. Serial

The MX200 can be used as both a Parallel and Serial (in-line) effects processor. Typically, reverbs and delays are used in parallel, compressors and de-essers in serial, and modulated effects can be used in either configuration, depending on the desired application.

A *Parallel Processor* is connected by sending a copy of a signal (such as from an Aux Send of a mixer channel) to an effects device (such as the MX200), and the effected (or wet) signal is returned to the mixer or amp. It is then blended together with the original unaffected (dry) signal. This blend is called the Wet/Dry mix. This connection is most often used for reverbs, delays, and some modulated effects (such as chorus).

A *Serial Processor* is connected by sending the entire signal through the effects device and then to an amplifier or mixer, and is not blended with the unaffected (dry) signal. This is the type of connection most often used for a compressor, de-esser, equalizer, and many modulated effects (such as tremolo, vibrato, and rotary).

The following illustrations show how to connect the MX200 in both Serial and Parallel configurations, using some common, real-world examples.

Parallel Connection

Mixer - Mono In/Stereo Out Setup

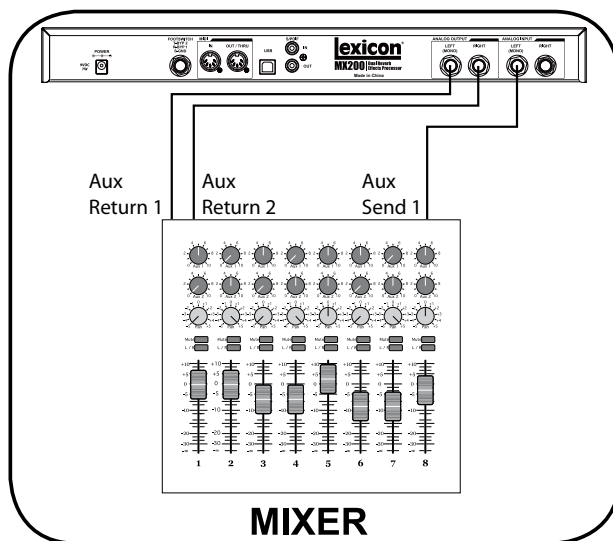

This setup is the most commonly used configuration in both live and studio applications.

1. Select routing 2 or 4 using the **Routing** button.
2. Connect the mixer's Post Fader Aux Send output to the MX200's **Left** (Mono) input.
3. Connect the MX200's **Left** and **Right** outputs to a stereo Aux Return input on the mixer (or a stereo line input, or two adjacent line inputs if you like).
4. Set the gain on the mixer's input channel appropriate to the source (vocal mic, guitar, keyboard, etc.).
5. Set the Aux Master level (if provided on your console) to the 12 o'clock position.
6. Set the **Input** on the MX200 to the 12 o'clock position.
7. Set the **Mix 1** and **Mix 2** knobs on the MX200 to their full clockwise (Wet) position.
8. Turn up the Aux Send level on the channel corresponding to the Post-fader Aux Send (Aux 1 in this example) that the MX200 is connected to until the red **Input Bargraph** LEDs light only occasionally. If the red **Input**

Bargraph LEDs stay lit, too much signal is being sent to the MX200; reduce the Aux Master or Aux send on the mixer.

9. Turn up the Aux Return to the 12 o'clock position (or line input faders to the 0db positions, if you used that connection).
10. To increase or decrease the amount of effect on the signal, adjust the Aux Send level on the channel that you want affected.

Mixer - Dual Mono Setup

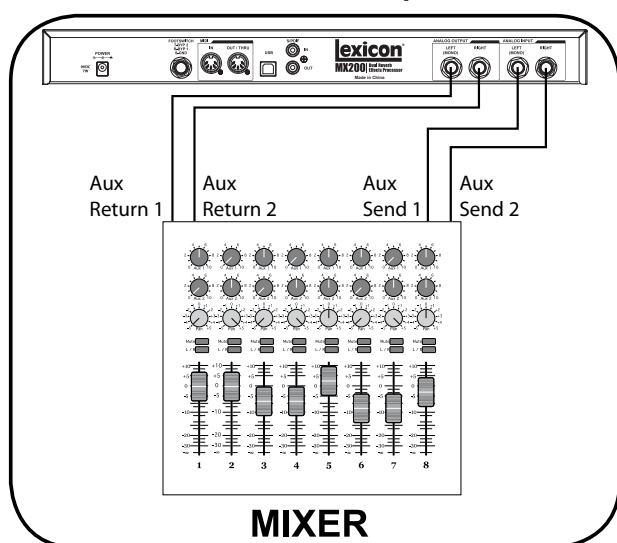

This setup applies to a mixer with two (or more) Aux Sends and Returns. It utilizes the two effect sections in the MX200 as two separate effects with separate mono outputs, or a common stereo output.

1. Select routing 1 or 4 using the **Routing** button.
2. Connect Aux 1 send to the MX200 **Left** input.
3. Connect Aux 2 send to the MX200 **Right** input.
4. Connect the MX200 **Left** and **Right** outputs to the mixer's Aux returns 1 and 2 for mono, or Stereo Aux L/R returns for stereo.
5. Set **Mix 1** and **Mix 2** knobs fully clockwise (Wet).
6. Set the MX200's **Input** knob to the 12 o'clock position.
7. Set the Aux Return levels on the mixer

to 12 o'clock.

8. Turn up Aux Sends 1 and 2 on the mixer for the selected channels so the red **Input Bargraph** LEDs only light occasionally with signal (adjusting the **Input** knob on the MX200 may be necessary).
9. Control the amount of effect using the Aux Send levels on the selected mixer channels.

Serial Connections

Guitar - Effects Loop Setup

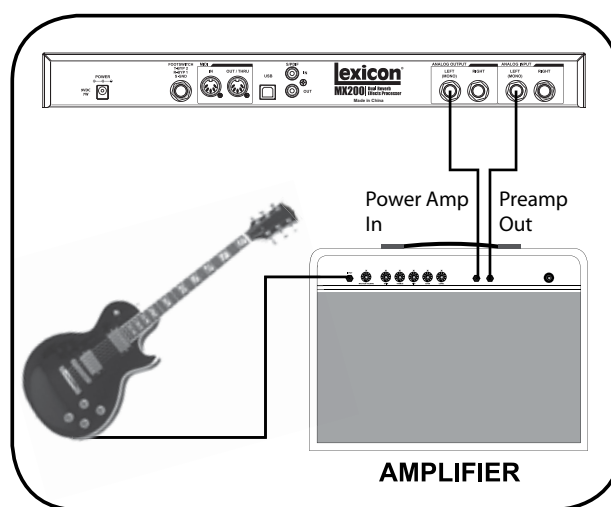

1. Select routing 2 using the **Routing** button (you can always experiment using other routings).
2. Connect guitar to the amp's Input.
3. Connect the amp Effects Loop Send or Preamp Out to the MX200's **Left** input.
4. Connect the MX200's **Left** output to the amp's Effects Loop Return or Power Amp In.
5. Set **Mix 1** and **Mix 2** knobs to the 12 o'clock position.
6. Adjust the **Input** level so the red **Input Bargraph** LEDs only light occasionally with signal.
7. To adjust the effect level, use the **Mix 1** and **Mix 2** knobs.

Setup

Instrument – In Line Setup

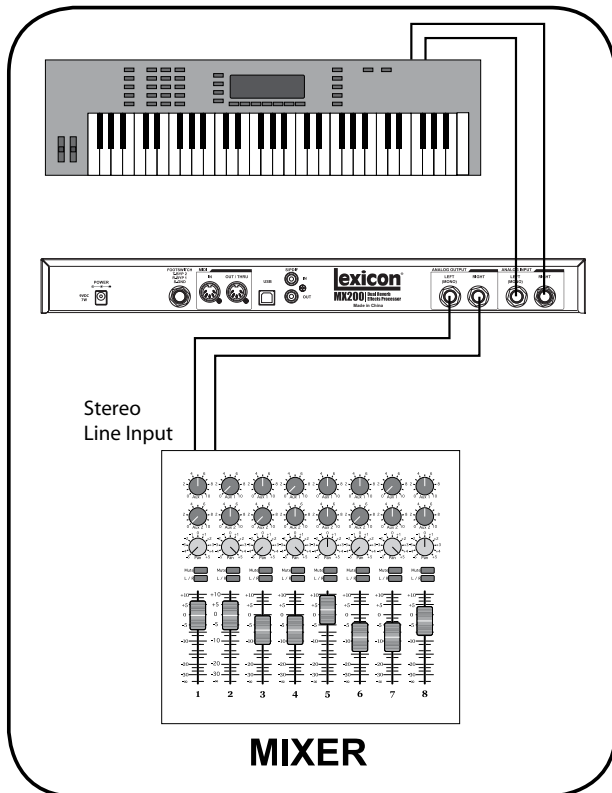

This setup utilizes the MX200 as a multi-effects processor connected in line from an instrument to a mixer. It is an ideal setup to use when your mixer does not have an Aux Send/Return option built in.

1. Select routing 2 using the **Routing** button (you can always experiment using other routings).
2. Connect a line level signal directly from your instrument to the MX200 Inputs. (use **Left** input for mono signals).
3. Connect the MX200's **Left** and **Right** outputs to two separate mixer channels or a stereo line input.
4. Set the MX200's **Input** knob to the 12 o'clock position.
5. Set **Mix 1** and **Mix 2** knobs to 12 o'clock position.
6. Adjust the **Input** level so the red **Input Bargraph** LEDs only light occasionally with signal.
7. Adjust the **Mix 1** and **Mix 2** knobs for the desired effect mix level.

Studio – Digital Setup

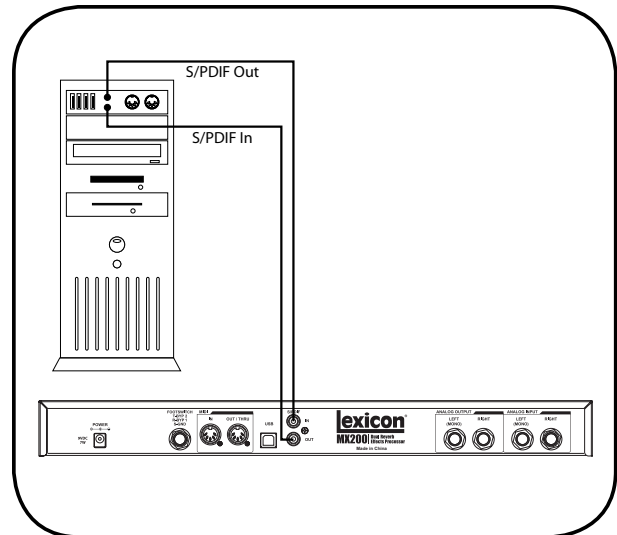

This setup is ideal if you are using the MX200 as a hardware plug-in in a digital recording system. This setup requires that you are using an I/O device with S/PDIF In/Out, or a digital mixer with S/PDIF I/O option.

1. Select routing 2 using the **Routing** button. (You can always experiment with other routings.)
2. Connect the S/PDIF output on your soundcard, audio interface or mixer to the **S/PDIF In** on the MX200.
3. Connect the MX200 **S/PDIF Out** to the S/PDIF input on your soundcard, audio interface or mixer.
4. Make sure the device you are connecting to the MX200's **S/PDIF In** is set as the Clock Master (if that option is available) and transmitting at a sample rate of 44.1kHz or 48kHz only. (Refer to the documentation for your device and/or software for proper setup.)
5. Once the MX200 is locked correctly with your device, the **Digital In** LED lights. If the **Digital In** LED does not light, check your cables and make sure that your I/O device is set as Master Clock.

Using the MX200

The MX200 is equipped with 99 Factory programs that combine the 32 reverbs and effects to cover a wide range of applications. Additionally, there are 99 User program locations in which to store your own reverb and effects combinations. These are identical to the Factory programs until you change them.

Loading Programs

To load a program:

1. Choose a program by rotating the **Program Select** knob. The selected program number flashes in the **Program Display** until loaded. A small LED dot appears in the lower right portion of the **Program Display** if a User program is selected.
2. Press the **Program Select** knob to load the program.

If you would like the programs to be loaded automatically as they are changed with the **Program Select** knob, you can enable the **AutoLoad** function (see page 23 for more information).

Editing Programs

After selecting a Factory or User program, you may find that it needs some modification for a particular application or use. This may include changing one of the three **Parameter** knobs on each processor, changing the **Mix 1** or **Mix 2** settings, altering the **Routing**, changing the delay **Tempo** or engaging one of the **Bypass** buttons. When any of the **Parameter** or **Mix** knobs are used, a numerical value for that parameter will briefly appear in the **Program Display** while the knob is being turned. A small LED next to the knob will illuminate, denoting a change from the saved value, and the **Store** button will light, indicating that the loaded program

has been modified. To retain these changes, you must store them to a User program location (see **Storing Programs**).

Knob and button LEDs are green for Processor 1, and red for Processor 2, to correspond with their respective LED color in the **Active Reverb/Effects Matrix**. Either Factory or User programs may be edited, but they may only be stored to a User program location.

The **Parameter** knobs have different functions for each reverb and effect. For detailed descriptions of what each knob does, refer to the **Effects Descriptions** section.

To edit a program:

1. Load a program using the **Program Select** knob.
2. Make any of the following adjustments or changes:
 - Select effects with either or both **Effect Select** buttons.
 - Modify the program with the **Pre Delay**, **Decay**, or **Variation** knobs.
 - Bypass a processor using P1 or P2 **Bypass** button.
 - Change tempo using the P1 or P2 **Tempo** button.
 - Adjust the Wet/Dry mix for either or both processors with the **Mix 1** and **Mix 2** knobs.
 - Change effect routings with the **Routing** button.

Selecting Effects

The MX200 features 16 classic Lexicon® reverb algorithms, six types of delay, eight modulated/pitch effects, and two dbx® dynamics algorithms.

To select an effect, press the P1 or P2 **Effect Select** buttons up or down.

Using the MX200

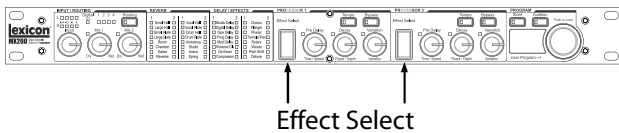

An LED lights next to the selected reverb or effect label in the **Active Reverb/Effects Matrix** (green LED for P1, red for P2).

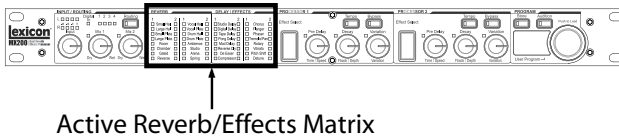

The **Effect Select** control is cyclical, meaning if **Effect Select** is pressed **up** when *Small Hall* is active, *Detune* will be the next selected effect. Similarly, if *Detune* is active, and **Effect Select** is pressed **down**, the effect will change to *Small Hall*.

Tap Tempo

Tap tempo can be used to match the delay times to synchronize with the music. The **Tempo** button LED flashes when a delay is loaded. To set tempo from the front panel, press the **Tempo** button twice in time with the music. The LED will flash at a rate that corresponds to the new tempo.

MX200 can also use MIDI Sync to set the tempo of delays. When MX200 detects MIDI Sync present at the **MIDI In**, the **Tempo** LEDs light constantly to indicate that tempo is set via MIDI Sync.

Changes made to tempo with the **Tempo** button are considered program edits, and cause the **Store** button LED to light.

The Audition Feature

The **Audition** feature provides 5 digitally recorded audio samples that are played back through MX200's processors at the touch of a button. This lets you preview the selected program and dial in reverb or effects settings without the need for an external audio source.

In the default setting, each tap of the **Audition** button plays the next sample. To play a single sample repeatedly, change the **Audition** options.

To change Audition options:

1. Press and hold the **Audition** button. The LED flashes, and the **Program Display** alternately displays *AL* and *AL*.
2. Turn the **Program Select** knob to select the individual sample you want to hear when you press the **Audition** button.

The samples are:

- AL* - **Audition All Samples**. Each time the **Audition** button is pressed, the next sample is played.
- A1* - **Drum Stick Click**
- A2* - **Snare Drum**
- A3* - **Kick Drum**
- A4* - **Female Vocal "Doo"**
- A5* - **Acoustic Guitar Arpeggio**

3. Press the **Store** button to save the new **Audition** setup

The **Audition** button now plays the selected sample each time it is pressed. The **Audition** sample is a global setting, and is not saved with presets.

Routing Options

The MX200's powerful Dual Processor design and four signal routing options allow you to use it as two independent effects processors, or combine the reverbs and effects for a nearly limitless palette of complex sounds.

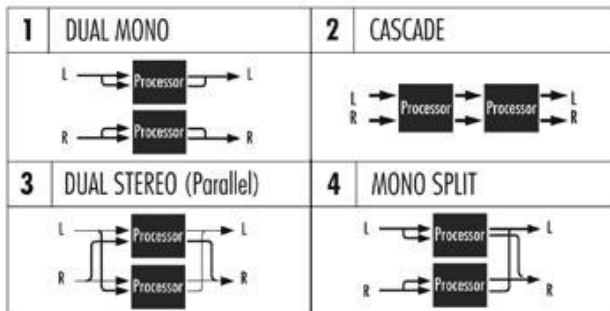

1. Dual Mono

This routing option sends the Left and Right input signals through Processor 1 and Processor 2 respectively. Each signal is then routed to its respective output, completely independent from the other.

2. Cascade

Left and Right input signals are sent first through Processor 1, then through Processor 2, then routed as a stereo signal to their respective outputs.

3. Dual Stereo (Parallel)

Left and Right input signals are sent through both processors independently. The output signals of both processors are then mixed together, and routed to both the outputs as a single stereo signal.

4. Mono Split

Left input signal is sent through Processor 1, while the Right input signal is sent through Processor 2. The output signals of both processors are then mixed together, and routed to both the outputs as a single stereo signal.

Storing Programs

Once you have edited a program to your liking, you can store these edits into a User program memory location. To store a program, follow these steps:

1. Press the **Store** button once. St appears briefly in the **Program Display**, followed by the flashing User program number (indicated by the small dot over **User Program** being lit).
2. Use the **Program Select** knob to select a User program location to store your edits.
3. Press the **Store** button again to complete the procedure.

To return to the program without storing changes, press any other button on the front panel.

Effects Descriptions

The MX200 effects come in four varieties: Stereo, Mono In/Stereo Out, Mono (Wet only), and Stereo (Wet only). When using Wet only effects, turn the processors **Mix** knob fully clockwise.

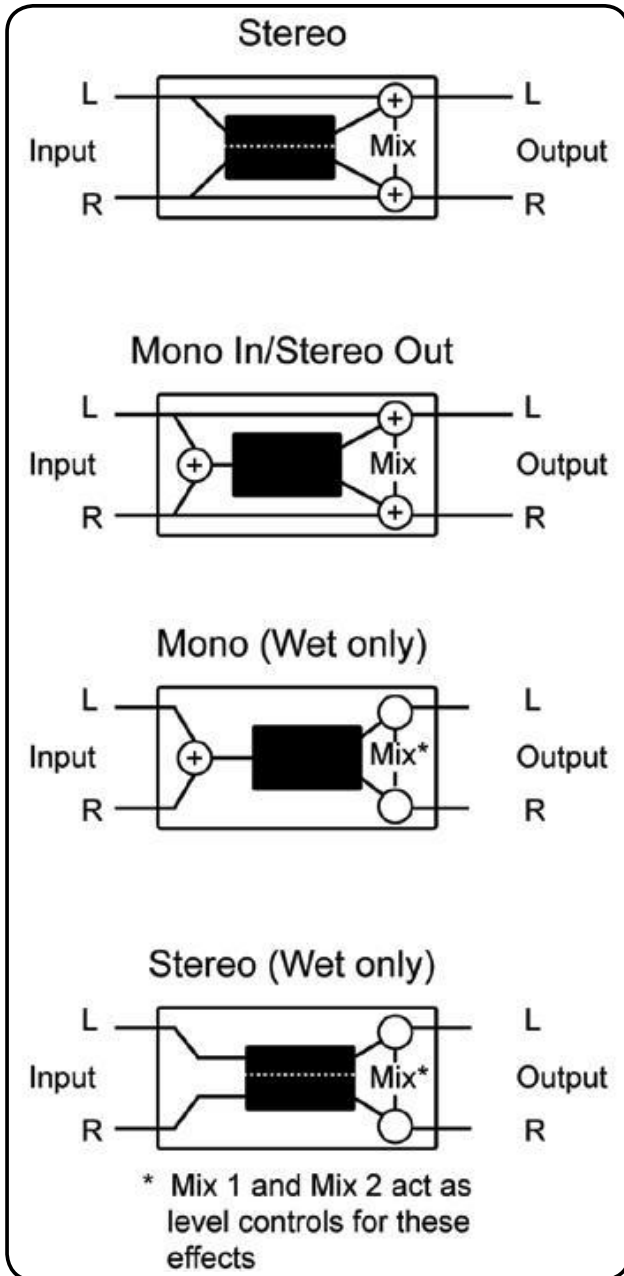

Reverbs

Reverberation (or “reverb” for short) is the complex effect created by the way we perceive sound in an enclosed space. When sound waves encounter an object or boundary, they don’t just stop. Some of the sound is absorbed by the object, but most of the sound is reflected or is diffused. In an enclosed space, reverb is dependent on many features of that space, including the size, shape and the type of materials that line the walls. Even with closed eyes, a listener can easily tell the difference between a closet, a locker room and a large auditorium. Reverb is a natural component of the acoustic experience, and most people feel that something is missing without it.

Hall Reverbs	<i>Stereo</i>
Small Hall	
Large Hall	
Vocal Hall	
Drum Hall	

A **Hall** is designed to emulate the acoustics of a concert hall – a space large enough to contain an orchestra and an audience. Because of the size and characteristics, Halls are the most natural-sounding reverbs, designed to remain “behind” the direct sound – adding ambience and space, but leaving the source unchanged. This effect has a relatively low initial echo density which builds up gradually over time. **Vocal Hall** and **Drum Hall** reverbs are specifically tailored for those uses. **Vocal Hall** has a lower overall diffusion which works well with program material that has softer initial transients like a voice. **Drum Hall** has a higher diffusion setting which is necessary to smooth out faster transient signals found in drums and percussion instruments. In addition to general instrumental and vocal applications, the **Hall** program is a good choice for giving separately recorded tracks the sense of belonging to the same performance.

Plate Reverbs

Stereo

Small Plate
Large Plate
Vocal Plate
Drum Plate

A **Plate** reverb is a large, thin sheet of metal suspended upright under tension on springs. Transducers attached to the plate transmit a signal that makes the plate vibrate, causing sounds to appear to be occurring in a large, open space. The **Plates** in the MX200 model the sound of metal plates with high initial diffusion and a relatively bright, colored sound. **Plate** reverbs are designed to be heard as part of the music, mellowing and thickening the initial sound. **Plate** reverbs are often used to enhance popular music, particularly percussion.

Room Reverb

Stereo

Room produces an excellent simulation of a very small room which is useful for dialog and voiceover applications. **Room** is also practical when used judiciously for fattening up high energy signals like electric guitar amp recordings.

Chamber Reverb

Stereo

Historically, recording studio chambers were oddly shaped rooms with a loudspeaker and set of microphones to collect ambience in various parts of the room. **Chamber** programs produce even, relatively dimensionless reverberation with little color change as sound decays. The initial diffusion is similar to the **Hall** programs. However, the sense of size and space is much less obvious. This characteristic, coupled with the low color of the decay tail, makes these programs useful on a wide range of material - especially the spoken voice, to which **Chamber** programs add a noticeable increase in loudness with low color.

Gated Reverb

Mono In/Stereo Out

Gated reverb is created by feeding a reverb, such as a metal plate, through a gate device. Decay Time is set to instant, while Hold Time varies duration and sound. The **Gated** reverb provides a fairly constant sound with no decay until the reverb is cut off abruptly. This program works well on percussion — particularly on snare and toms; be sure to experiment with other sound sources as well.

Reverse Reverb

Mono In/Stereo Out

Reverse reverb works in the opposite fashion from normal reverb. Whereas a normal reverb has the loudest series of reflections heard first that then become quieter over time, the **Reverse** reverb has the softest reflections (essentially the tail of the reverb) heard first, and then grows louder over time until they abruptly cut off.

Ambience Reverb

Stereo

Ambience is used to simulate the effect of a small or medium sized room without noticeable decay. It is often used for voice, guitar or percussion.

Studio Reverb

Stereo

Much like **Room** reverb, **Studio** produces an excellent simulation of smaller, well-controlled acoustic spaces, characteristic of the main performance areas in recording studios. **Studio** is also useful with dialog and voiceover applications as well as individual instrument and electric guitar tracks.

Arena Reverb

Stereo

Arena reverb emulates a huge physical space such as an indoor sports venue or stadium. The characteristics of **Arena** reverb are long secondary reflection times and a reduced amount of high frequency content. **Arena** is a mostly mid- and low-frequency dominant reverb, and is an ideal selection for “special effect” type applications that require extremely long reverb times. It is not a good choice for a very busy mix, since it can reduce intelligibility.

Spring Reverb

Mono In/Stereo Out

A **Spring** reverb is created by a pair of piezoelectric crystals—one acting as a speaker and the other acting as a microphone—connected by a simple set of springs. The characteristic ‘boing’ of a spring is an important component of many classic rock and rockabilly guitar sounds.

Reverb Controls

Pre Delay

Creates an additional time delay between the source signal and the onset of reverberation. This control is not intended to precisely mimic the time delays in natural spaces, as the build-up of reverberation is gradual, and the initial time gap is usually relatively short. For the most natural effect, the **Pre Delay** values should be set in the range of 10-25 milliseconds. However, if a mix is very busy or overly cluttered, increasing the **Pre Delay** time may help clarify it, and set each instrument apart from each other.

Decay

Controls the amount of time the reverb can be heard. Higher settings increase reverberation times which are usually associated with larger acoustical environments, but can decrease intelligibility. Lower settings shorten reverb times and should be used when a smaller apparent space or a more

subtle effect is desired.

Liveliness

Adjusts the amount of high frequency content in the reverberation tails. Higher settings increase high frequency response, creating brighter reverbs; lower settings create darker reverbs with more bass frequency emphasis.

Diffusion

Controls the initial echo density. High settings of Diffusion result in high initial echo density, and low settings cause low initial density. In a real-world situation, irregular walls cause high diffusion, while large flat walls cause low diffusion. For drums and percussion, try using higher Diffusion settings.

Shape

This control helps give a sense of both room shape and room size. Low values for Shape keep the majority of sound energy in the early part of the reverb tail. High values move the energy to later in the reverb, and are helpful in creating the sense of a strong rear wall or “backslap.”

Boing

This is a unique parameter to the **Spring** reverb, designed to increase or decrease the amount of spring rattle that is a physical characteristic of spring tank reverbs.

Reverb Control Values

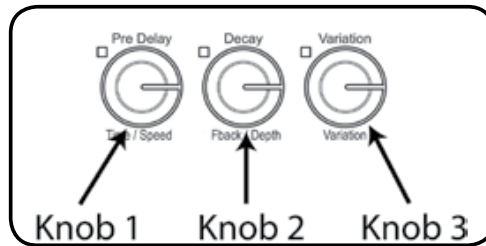

Reverb	Knob 1	Knob 2	Knob 3
Small Hall	<u>PreDelay</u> 0 - 100 ms	<u>Decay</u> 0 - 99	<u>Liveliness</u> 0 - 99
Large Hall	<u>PreDelay</u> 0 - 200 ms	<u>Decay</u> 0 - 99	<u>Liveliness</u> 0 - 99
Small Plate	<u>PreDelay</u> 0 - 100 ms	<u>Decay</u> 0 - 99	<u>Liveliness</u> 0 - 99
Large Plate	<u>PreDelay</u> 0 - 200 ms	<u>Decay</u> 0 - 99	<u>Liveliness</u> 0 - 99
Room	<u>PreDelay</u> 0 - 100 ms	<u>Decay</u> 0 - 99	<u>Liveliness</u> 0 - 99
Chamber	<u>PreDelay</u> 0 - 100 ms	<u>Decay</u> 0 - 99	<u>Liveliness</u> 0 - 99
Gated	<u>PreDelay</u> 0 - 200 ms	<u>Decay</u> 0 - 60	<u>Diffusion</u> 0 - 99
Reverse	<u>PreDelay</u> 0 - 200 ms	<u>Decay</u> 0 - 60	<u>Diffusion</u> 0 - 99
Vocal Hall	<u>PreDelay</u> 0 - 200 ms	<u>Decay</u> 0 - 99	<u>Liveliness</u> 0 - 99
Vocal Plate	<u>PreDelay</u> 0 - 200 ms	<u>Decay</u> 0 - 99	<u>Liveliness</u> 0 - 99
Drum Hall	<u>PreDelay</u> 0 - 100 ms	<u>Decay</u> 0 - 99	<u>Liveliness</u> 0 - 99
Drum Plate	<u>PreDelay</u> 0 - 100 ms	<u>Decay</u> 0 - 99	<u>Liveliness</u> 0 - 99
Ambience	<u>PreDelay</u> 0 - 100 ms	<u>Shape</u> 0 - 99	<u>Liveliness</u> 0 - 99
Studio	<u>PreDelay</u> 0 - 100 ms	<u>Decay</u> 0 - 99	<u>Liveliness</u> 0 - 99
Arena	<u>PreDelay</u> 0 - 200 ms	<u>Decay</u> 0 - 99	<u>Liveliness</u> 0 - 99
Spring	<u>PreDelay</u> 0 - 100 ms	<u>Decay</u> 0 - 99	<u>Boing</u> 0 - 99

Note: Values of 0 – 100 are displayed as $\square - \square\square$ (100 is displayed as $\square\square$ in the **Program Display**). Values of greater than 100 are shown with a decimal between the digits, i.e. 115 displayed as $1 \ .5$, 150 displayed as $5 \ .0$, and 200 is displayed as $2 \ .0$.

Delays

Delays repeat a sound a short time after it first occurs. Delay becomes echo when the output is fed back into the input (feedback). This turns a single repeat into a series of repeats, each a little softer than the last.

Studio Delay *Stereo*

The **Studio Delay** features up to 2.5 seconds of stereo delay and offers a built-in ducker that attenuates the delay output whenever signal is present at the input. This can be used to keep the original signal from being muddled up by delay repeats.

Digital Delay *Mono In/Stereo Out*

The **Digital Delay** is the cleanest, most accurate of the delay programs, with up to 5 seconds of mono delay and the built-in ducking feature.

Tape Delay *Mono In/Stereo Out*

In the days before digital, delays were created using a special tape recorder in which the magnetic recording tape was looped, with closely-spaced recording and playback heads. The delay effect was created by the tape moving in the space between the record and playback heads – while delay time was adjusted by changing the speed of the tape loop. Although very musical-sounding, wow and flutter combined with a significant loss of high frequencies, and to some extent also low frequencies, are all elements commonly associated with tape recordings. The **Tape Delay** offers up to 5 seconds of mono delay.

Pong Delay *Mono In /Stereo Out*

This delay effect pans the delay repeats from left to right, while the input signal remains at its original (center) position. **Pong Delay** offers up to 5 seconds of mono delay time.

Modulated Delay *Stereo*

The **Modulated Delay** is enhanced by an LFO (low frequency oscillator) that produces a chorusing effect on the delay repeats. This is a great delay for guitar and instrument passages that need that “special something.” The **Modulated Delay** features up to 2.5 seconds of stereo modulated delay.

Reverse Delay *Mono In/Stereo Out*

This delay effect emulates the old studio trick of flipping a tape over, playing it backwards through a tape delay, and recording the effect. The delays “build up” from softer to louder – creating the sensation that the delays come before the signal. Very cool when used judiciously. Up to 5 seconds of mono delay time are available.

Delay Controls

Time Range

Controls the length of the delay relative to Tap Tempo. At the 12 o'clock position, delay repeats are synchronous with the Tempo light (represented by a Quarter Note); lower values create faster repeats, higher values increase the time between repeats. Range 0-72. See Appendix on page 39 for exact note values.

Feedback

Controls the number of delay repeats by feeding the delay output signal back into the delay input. This creates a series of delay repeats, each slightly attenuated until they become inaudible. Higher settings create more repeats; lower settings reduce the number of repeats. When this knob is turned fully clockwise, it engages Repeat Hold – delay repeats play back in an infinite loop, but no further input signal is introduced into the delay effect. Repeat Hold is available only on **Studio**, **Digital** and **Pong Delay**.

Ducker Threshold

MX200's **Studio** and **Digital** delays offer a "ducking" feature, which causes the delay repeats to attenuate (or get softer) by -6dB when live (or input) signal is present. This allows the delay to remain as an effect, and not clash with the original signal. The higher this value is set, the louder an input signal must be for the ducking to take place.

Smear

This parameter controls the amount of "smear," or signal degradation and frequency loss. Particularly evident in the **Tape Delay**, the higher the setting, the more each delay repeat loses intelligibility compared to the original signal.

Tap Ratio

Tap Ratio sets the length between the first and second tap repeats of the **Pong Delay**. With this control set at 12 o'clock,

repeats are evenly alternated between left and right channels. As this knob is turned counter-clockwise, the first tap occurs earlier and the second tap occurs later than they did at the 12 o'clock position. When the knob is turned clockwise, the first tap occurs later and the second tap occurs earlier.

Depth

This controls the intensity of modulation, or "depth" in the **Modulated Delay**. Lower settings produce a more subtle effect, while higher values give a more "seasick" feeling.

Tempo Button

Tapping this button twice sets the delay times. The **Tempo** button LED flashes the tempo tapped in, and delay taps will be synchronized to the flashing LED. Use the **Time Range** knob to increase or decrease delay times after tapping in a tempo.

Delay Control Values

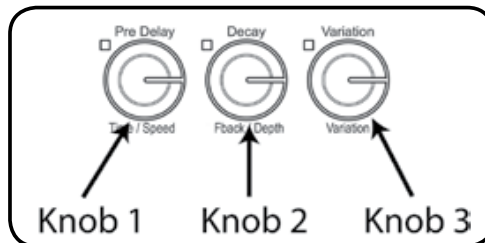

Delay Type	Knob 1	Knob 2	Knob 3
Studio Delay	<u>Time Range</u> 0 - 72	<u>Feedback</u> 0 - 99+RH	<u>Duck Threshold</u> -70 - 0dB
Digital Delay	<u>Time Range</u> 0 - 72	<u>Feedback</u> 0 - 99+RH	<u>Duck Threshold</u> -70 - 0dB
Tape Delay	<u>Time Range</u> 0 - 72	<u>Feedback</u> 0 - 99	<u>Smear</u> 0 - 99
Pong Delay	<u>Time Range</u> 0 - 72	<u>Feedback</u> 0 - 99+RH	<u>Tap Ratio</u> 0 - 23
Mod Delay	<u>Time Range</u> 0 - 72	<u>Feedback</u> 0 - 99	<u>Mod Depth</u> 0 - 99
Reverse Delay	<u>Time Range</u> 0 - 72	<u>Feedback</u> 0 - 99	<u>Smear</u> 0 - 99

Note: When **Feedback** is turned past 99, the value displays as *rh* to indicate Repeat Hold. (**Studio**, **Digital**, and **Pong** delays only.)

dbx® Dynamics

De-Esser

Mono (Wet only)

A **De-Esser** is a type of compressor used to control specific frequencies. Excessive sibilance, or the “s” sounds, can be tamed by applying this effect.

Knob 1	Knob 2	Knob 3
<u>Ratio</u> 1:1 - Inf:1	<u>Freq Range</u> 0 - 40	<u>Bandwidth</u> 0 - 5

De-Esser Controls

Knob 1: Compression Ratio

Determines the amount of compression, from 1:1 (no effect) to Infinity:1 (complete limiting).

Knob 2: Frequency Range

Selects the frequency range of compression in 40 discrete steps from 1600Hz to 10kHz (the most common frequencies in which excessive sibilance occurs).

Knob 3: Bandwidth (Q)

Controls the bandwidth or “Quality” (Q) of frequency range. The higher the selected value, the tighter the bandwidth, and less apparent the de-essing effect is. Incremental in six steps from 1/4 Octave (0) to 1/24th Octave (5). See Appendix on page 39 for bandwidth values.

Compressor

Mono (Wet only)

A compressor is used to control the dynamic range of a signal. Typically used to tighten bass or drum tracks, or to control a vocal passage, a compressor is a very useful but often misunderstood tool. To better use the **Compressor** in the MX200, a bit of understanding about compression is helpful.

When a signal level crosses the **Threshold** level, the compressor then reduces the amount of output level by an amount deter-

mined by the **Ratio**. For example, if the threshold is set to -12dB, and the ratio set to 4:1, then when signal exceeds -12dB, the signal level above that amount only increases by 1dB to every 4dB of signal level above -12dB. In this case, an incoming signal of -4dB (which is 8dB above the threshold) would result in an output signal of -10dB, or 2dB higher than the threshold level, since the 4:1 compression ratio only allowed 2dB more output, based on the 8dB increase above the -12dB threshold.

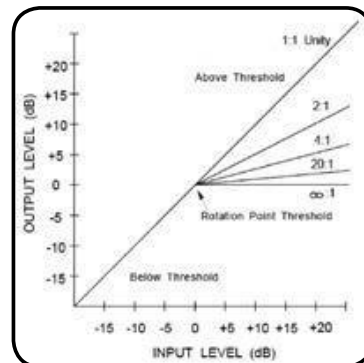

Because the resulting output is less than the original signal, a third control, **Makeup Gain** compensates for this loss of level, but with less dynamic range, or the difference between the softest and loudest parts of the signal.

Knob 1	Knob 2	Knob 3
<u>Threshold</u> -70dB - 0dB	<u>Ratio</u> 1:1 - Inf:1	<u>Gain</u> 0dB - +12dB

Compressor Controls

Knob 1: Threshold

Determines the threshold above which compression begins, incrementally between -70dB and 0dB (FS).

Knob 2: Compression Ratio

Selects the compression ratio, from 1:1 (no effect) to Infinity:1 (or complete limiting).

Knob 3: Makeup Gain

Increases the output level to compensate for signal attenuation during compression. Incremental between 0dB (no gain) to +12dB.

Modulated Effects

Chorus

Stereo

Chorus creates a lush, full sound by combining two or more signals together where one is unaffected and the other signals vary in pitch very slightly over time. **Chorus** is commonly used to fatten up tracks and to add body to guitars without coloring the original tone. **Chorus** can also be used with discretion to thicken a vocal track.

<i>Knob 1</i>	<i>Knob 2</i>	<i>Knob 3</i>
<u>Speed</u>	<u>Depth</u>	<u>Voices</u>
0 - 99	0 - 99	0 - 99

Chorus Controls

Knob 1: Speed

Controls the modulation rate of the **Chorus** effect. Lower settings are subtle, while higher values are much more pronounced.

Knob 2: Depth

Controls the amount of pitch shifting for each voice. Lower settings provide subtle thickening and warmth to a track, while higher settings give a more pronounced, multi-voice effect.

Knob 3: Voices

Controls the number of additional **Chorus** voices. Up to 8 voices can be added, continuously variable in 100 individual steps.

Flanger

Stereo

This effect was originally created by simultaneously recording and playing back two identical programs on two tape recorders, then using hand pressure against the flange of the tape reels to slow down first one machine, then the other. The result was a series of changing phase cancellations and reinforcements, with characteris-

tic swishing, tunneling, and fading sounds.

<i>Knob 1</i>	<i>Knob 2</i>	<i>Knob 3</i>
<u>Speed</u>	<u>Depth</u>	<u>Regen</u>
0 - 99	0 - 99	0 - 99

Flanger Controls

Knob 1: Speed

Controls the modulation rate of the **Flanger** effect.

Knob 2: Depth

Controls the intensity of the **Flanger** effect. Lower settings provide a slight “whooshing” sound while higher settings provide a much more dramatic “jet airplane” sound.

Knob 3: Regeneration

This knob controls the amount of modulated signal being fed back into the input, creating feedback. Higher amounts add a metallic resonance to the signal.

Phaser

Stereo

The **Phaser** automatically moves frequency notches up and down the spectrum of the signal by means of a low frequency oscillator (LFO), creating an oscillating “comb-filter” type effect. This effect is very useful on keyboards (especially pad presets) and guitars.

<i>Knob 1</i>	<i>Knob 2</i>	<i>Knob 3</i>
<u>Speed</u>	<u>Depth</u>	<u>Regen</u>
0 - 99	0 - 99	0 - 99

Phaser Controls

Knob 1: Speed

Controls the modulation rate of the **Phaser** effect.

Knob 2: Depth

Controls the intensity of the **Phaser** effect.

Knob 3: Regeneration

Effects Descriptions - Modulated Effects

This knob controls the amount of modulated signal being fed back into the input, creating feedback. Higher amounts add more resonance to the effect signal.

Tremolo/Pan *Stereo (Wet only)*

Tremolo and **Panner** create rhythmic changes in signal amplitude. **Tremolo** affects both channel's amplitude simultaneously, while the **Panner** affects the amplitude of each channel in an alternating manner.

<i>Knob 1</i>	<i>Knob 2</i>	<i>Knob 3</i>
<u>Speed</u>	<u>Depth</u>	<u>Phase</u>
0 - 99	0 - 99	0 - 99

Tremolo/Pan Controls

Knob 1: Speed

Controls the modulation rate of the **Tremolo/Panner**.

Knob 2: Depth

Controls the intensity of the volume amplitude change.

Knob 3: Phase

Controls whether the amplitude change occurs in both channels simultaneously (**Tremolo**) or alternates between channels (**Panner**).

Rotary *Mono (Wet only)*

Rotary speaker cabinets were designed to provide a majestic vibrato/choir effect for electronic theater and church organs. The most well known rotary speaker is the Leslie™ Model 122, which has two counter-rotating elements: a high-frequency horn and a low-frequency rotor with slow and fast speeds. The sound generated as the spinning elements change speed is truly magical. The swirling, spacious effect is difficult to describe – but clearly recognizable.

The **Rotary** effect is modeled after a Leslie-style cabinet. The input signal is split into high and low-frequency bands. The rotation effect is created by a synchronized combination of pitch shifting, tremolo, and panning. Like the physical cabinet, the high (horn) and low (rotor) frequencies are “spun” in opposite directions. Horn and rotor speeds are independent, and designed with acceleration and deceleration characteristics to simulate the inertia of the original mechanical elements.

A virtual requirement for organ music, **Rotary** also sounds remarkable with guitar and electric piano rhythm parts. In fact, these programs are great alternatives to the **Chorus** and **Tremolo** effects for any sound source.

<i>Knob 1</i>	<i>Knob 2</i>	<i>Knob 3</i>
<u>Speed</u>	<u>Doppler</u>	<u>Spread</u>
0 - 99	0 - 99	0 - 99

Rotary Controls

Knob 1: Speed

Controls the modulation rate of both rotary speakers. The lower frequencies rotate at a slower speed than the high frequencies.

Knob 2: Doppler

Increases or decreases the Doppler pitch effect that is created by the physics of a rotating speaker.

Knob 3: Stereo Spread

Increases or decreases the stereo imaging of the **Rotary** effect.

Vibrato *Stereo (Wet only)*

Vibrato is obtained by smoothly varying the pitch of the signal just sharp and flat of the original at a determined rate.

Knob 1	Knob 2	Knob 3
<u>Speed</u> 0 - 99	<u>Depth</u> 0 - 99	<u>Phase</u> 0 - 99

Vibrato Controls

Knob 1: Speed

Controls the modulation rate of **Vibrato**.

Knob 2: Depth

Controls the maximum amount of pitch shift. Lower settings result in a mere “warble,” while higher settings produce a more exaggerated “wow” sound.

Knob 3: Phase

This control sets left and right channel waveforms out of phase, resulting in a left-to-right panning motion.

Pitch Shift Stereo

This effect shifts the frequency spectrum of the input signal. Altering the pitch of a sound produces a wide range effects - from subtle detunes to full interval shifts up or down a two octave range. The MX200’s **Pitch Shift** effect is a chromatic shifter, meaning all notes of the scale are shifted by the same interval. **Pitch Shift** is very useful with guitar tracks, monophonic synth lines, or where special vocal effects are needed.

Knob 1	Knob 2	Knob 3
<u>Shift</u> 0 - 24	<u>Up/Down</u> Up/Dn	<u>Cutoff Freq</u> 0 - 55

Pitch Shift Controls

Knob 1: Shift Amount

Determines the amount of pitch shifting. Range is 0-24 semitones (2 octaves).

Knob 2: Down/Up Shift

Determines whether the pitch shifting is up or down from the original signal.

Knob 3: Cutoff Frequency

This controls the cutoff frequency of the low pass filter. Lower settings roll off high frequency response.

Detune Stereo

Detune adds a slightly pitch-shifted version of the original source, thickening the sound. This creates a particularly effective simulation of “double-tracking.” This effect is also a great alternative to the **Chorus** effect, adding the richness of a chorus without the audible sweep caused by the chorus rate.

Knob 1	Knob 2	Knob 3
<u>Shift</u> 0 - 48	<u>Shift</u> 0 - 48	<u>Spread</u> 0 - 99

Detune Controls

Knob 1: Left Shift Amount

Determines the **detune** amount of the **Left** input, from -24 cents to +24 cents.

Knob 2: Right Shift Amount

Determines the **detune** amount of the **Right** input, from -24 cents to +24 cents.

Knob 3: Stereo Spread

Higher values increase the perceived distance of the detuned voices in the stereo field.

MX200 Utilities

The MX200 has several global functions that can be customized to meet your needs. These functions are **MIDI Channel Select**, **Program AutoLoad** enable, **Dry Track** to digital output, **Analog/Digital Input Select**, and **Factory Reset**. To access these Utility functions, press and hold both the **Store** and **Audition** buttons simultaneously until the **Audition** button LED begins to flash. The **Program Display** reads *Ut* to indicate that you are in Utility mode rather than Program mode. Navigation between Utility functions is controlled by pressing the **Audition** button; changes are made by turning the **Program Select** knob.

MIDI Channel

The MX200 is capable of receiving incoming MIDI Program Change and CC (Continuous Controller) messages via a MIDI or USB connection. The MX200 can be set to receive on any single MIDI channel, all MIDI channels, or can have MIDI receive disabled.

To select the MIDI channel:

1. Press both the **Store** and **Audition** buttons simultaneously.
2. The first menu displayed when entering the Utility mode is the **MIDI Channel** menu. The **Program Display** alternates between *Ch* and *1* (1 is the factory default MIDI channel).
3. Use the **Program Select** knob to choose the MIDI channel that you want the MX200 to receive incoming MIDI Program Change and CC messages on. The range is *1-16*, *All* (omni), and *Off* (ignores incoming MIDI messages).
4. Press the **Store** button to save this change.

Program AutoLoad

From the factory, the MX200 is configured to have presets loaded manually once they are selected. This is useful in live applications when a performance requires different programs to be loaded that are not in adjacent memory locations. Select the program using the **Program Select** knob and then press the knob to load it for use. The previous program remains active until the new program is loaded. If you would like the programs to be loaded automatically as they are changed with the **Program Select** knob, you can enable the **AutoLoad** function.

To enable **AutoLoad**:

1. Press both the **Store** and **Audition** buttons simultaneously.
2. Press the **Audition** button repeatedly until *Lo* appears in the **Program Display**. The **Program Display** flashes between *Lo* and *Off*, indicating the **AutoLoad** feature is disabled.
3. Turn the **Program Select** knob until the display reads *On* to enable **AutoLoad**.
4. Press the **Store** button to save this change.

Analog / Digital Input Select

The MX200 has both analog and S/PDIF digital inputs and outputs available. The S/PDIF digital output is always operational and any incoming analog signal is processed and sent to both the analog and digital outputs. When a digital signal is received at the S/PDIF digital input from another device, the MX200 automatically disables the analog inputs and enables the digital input to receive signal from the external device. There are times however, you may want to leave the digital device connected but receive signal from the analog inputs.

To enable or disable the digital input:

1. Press both the **Store** and **Audition** buttons simultaneously.
2. Press the **Audition** button repeatedly until *ln* appears in the **Program Display**. The **Program Display** flashes between *ln* and *dl* if the digital input is selected. If you want to disable the digital input and use the analog inputs, turn the **Program Select** knob until the **Program Display** reads *an* to select the analog input.
3. Press the **Store** button to save this change.

Digital Out Dry Track

The MX200 can send unprocessed digital audio (**Dry Track**) out the **S/PDIF Digital Out** while monitoring processed audio through the analog outputs. This is useful when you want to record a dry performance digitally, but also hear effects processing while you a recording.

Note: The Dry Track feature is only available for signals brought into the MX200 via the analog inputs. Dry Track has no effect on signals being received at the **S/PDIF In**. Digital in/out signals are processed normally regardless of whether the Dry Track parameter is enabled or disabled.

To enable **Dry Track**:

1. Press both the **Store** and **Audition** buttons simultaneously.
2. Press the **Audition** button repeatedly until *dt* appears in the **Program Display**. The **Program Display** flashes between *dt* and *df*
3. Turn the **Program Select** knob until the **Program Display** reads *dn* to enable the **Dry Track** feature.
4. Press the **Store** button to save this change.

Stereo and Mono Output Modes

The MX200 outputs can be either Stereo or Mono depending on your application needs. When Stereo Output Mode is selected (MX200's default Output Mode), the signals maintain stereo separation as configured by the **Routing** button. When Mono Output Mode is selected, both **Left** and **Right** output signals are summed to mono and then sent out the **Left** output.

To select Mono or Stereo Output Modes:

1. Press both the **Store** and **Audition** buttons simultaneously until *lt* appears in the **Program Display**.
2. Press the **Audition** button repeatedly until *op* appears in the **Program Display**. This is the Output Mode setup menu. The **Program Display** alternately flashes *op* and then *st* to indicate Stereo Output Mode is selected.
3. To change the Output Mode to Mono, turn the **Program Select** knob until *nm* appears in the **Program Display** indicating Mono Output Mode is now selected.
4. Press the **Store** button to save these changes.

Note: When Mono Output Mode is selected, effects like Panner and Pong Delay will no longer have left to right animation as they do when Stereo Output Mode is selected.

Factory Program Banks: Serial and Parallel

The MX200 has two sets of Factory program banks: the Parallel bank and Serial bank. The Parallel processing bank is used when the MX200 is configured in an Auxiliary Send/Return setup with a mixer. The Serial bank is designed for use when the MX200 will have a signal source (such

as an instrument) connected directly to its inputs and the MX200's outputs are connected to a mixer or amplifier input channels. The difference between these two banks is the way the **Mix 1** and **Mix 2** controls are set in the Factory programs, providing the proper wet/dry mix for either application.

Note: The default Factory bank is the Serial bank. If you plan to use the MX200 as a Parallel device in a mixer Aux Send/Return setup, select the Parallel bank of Factory programs.

To select the Parallel bank of Factory programs:

1. Press both the **Store** and **Audition** buttons simultaneously until *UE* appears in the **Program Display**.
2. Press the **Audition** button repeatedly until *Fb* appears in the **Program Display**. This is the Factory Bank program select menu. The **Program Display** alternately flashes *Fb* and then *SE* to indicate the Serial bank of Factory programs is selected.
3. To select the Parallel bank of Factory programs, turn the **Program Select** knob until *PA* appears in the **Program Display**.
4. Press the **Store** button to save these changes.

Bypass Mode Select

From the factory, MX200 is configured so that engaging the Bypass button on P1 or P2 causes that processor to go into Bypass mode, allowing dry, unprocessed signal to pass through unaffected. There are cases when you may want to have this button mute the output altogether, allowing neither wet nor dry signal to pass. Note that this configuration should only be used for Routing options 1, 3 and 4; placing either Processor in Bypass (mute) when Routing 2 (Cascade) is selected will cause the MX200 to have no output, as the entire

signal is muted by the Processor placed in Bypass.

To change this setting:

1. Press both the **Store** and **Audition** buttons simultaneously.
2. Press the **Audition** button repeatedly until *bP* appears in the **Program Display**. The **Program Display** flashes between *bP* and *dr* (indicating dry signal).
3. Turn the **Program Select** knob until the display reads *no* (or no signal).
4. Press the **Store** button to save this change.

Factory Reset

Use this utility if you want to erase all User program data and restore the MX200 to its factory state.

To perform a **Factory Reset**:

1. Press both the **Store** and **Audition** buttons simultaneously.
2. Press the **Audition** button repeatedly until *Fr* appears in the **Program Display**.
3. To restore the MX200 to its factory state, press the **Store** button. The **Store** button begins to flash.

Warning: Pressing and holding the **Store** button again at this time resets all Utility menus to their factory defaults and permanently erases all User programs! This will not affect the Factory programs or any programs saved to your computer using the MX-Edit Librarian software.

4. Press and hold the **Store** button to complete the reset procedure. The display flashes *r5* to indicate the **Factory Reset** was successful.

The MX-Edit™ Editor/Librarian - Windows

The included MX-Edit Editor/Librarian software lets you create, edit, compare, save and load reverb and effects programs for use with your MX200 on your Windows® computer. While the MX200 has 99 User program locations, you can create and save as many programs you like on your computer, and load them into your MX200 via a USB or MIDI connection at any time.

Minimum System Requirements

Before installing the MX-Edit Editor/Librarian software, make sure that your computer meets the following minimum requirements:

- Pentium-III, 500MHz or better.
- Windows XP, Service Pack 2 or higher.

Installing the MX-Edit Editor/Librarian Software

To install the included MX-Edit Editor/Librarian software in Windows XP, insert the provided disc into your computer's CD-ROM drive. You will be guided through the installation process – just follow the on-screen instructions and prompts. Note that you will be prompted to connect the MX200 via the USB port during the installation process. In order for your computer to recognize the MX200 connection, it is necessary to have the MX200 powered on and connected via a standard USB cable.

Important: If you plug your MX200 into a USB port other than the one used during the installation of MX-Edit software and drivers, you may need to run the USB driver installer again. For your convenience, a shortcut to the USB driver installer is added to the Start menu during the MX-Edit software installation. If you need to reinstall the drivers, click Start->Program Files->Lexicon->MX-Edit->Reinstall Drivers, and follow the installation prompts.

Quick Start

When you first open MX-Edit, you will see the MX-Edit Library on the left side of the MX-Edit window, with the MX200 icon at the top of the Library.



Double-click the MX200 icon to expand the Library, then double-click the Factory or User icons to see the Factory or User program lists. The Factory list will always be the same, as Factory programs cannot be changed; the User program list will represent the programs currently residing in the User program locations 1-99 in your MX200 hardware.



Double-click a program name to open it in the editor. An instance of the MX-Edit Program Editor appears, with the selected program's name in the Title Bar and Program Name field. The program settings are also reflected in the Parameter knobs and buttons in the Program Editor window.

The MX-Edit Editor/Librarian - Windows

The selected program is now loaded in your MX200 as well, and can be previewed using the **Audition** button on the MX200's front panel. Any changes made in the MX-Edit Program Editor window will also occur simultaneously on the MX200 hardware.

The MX-Edit™ Library

The MX-Edit Library contains the 99 Factory and 99 User programs that are currently loaded in your MX200. When you first open MX-Edit, it communicates via USB (or MIDI) with the MX200 hardware, and populates the Library with all the information about each of the Factory and User programs stored in MX200's physical memory.

To view programs in the Library window, double-click on the MX200 icon in the upper left corner, then double-click the Factory or User icon to expand the Library and see the Factory or User program lists. The Factory list is always the same, as Factory programs cannot be overwritten; the User program list represents the 99 User programs currently saved in your MX200 hardware.

Opening or Creating a Program



To open a program, choose one of the following:

- To open a **Factory** or **User** program from the MX-Edit Library, double click on that program number in the Library window.
- To open a program that has been saved to your computer (but doesn't appear in the MX-Edit Library), click **File** and select **Open Program**. By default, the **Open** dialog looks in the **My Documents** folder (or the last folder that a program was opened from). Double-click the program to load it.
- To open a program with the currently active settings from the MX200, select **Open Current Program** in the **Device** menu. This will retrieve all current settings from the MX200's front panel, and display those settings in the Program Editor window.

To create a new, default program, click **File** and select **New Program**. The default program is a template that you can use as a good generic starting point when you want to create your own program from scratch. It is stored in a file named **Default** in the MX-Edit installation folder (normally *C:\Program Files\Lexicon\MX-Edit*). Initially,

this program is a basic clean sound. However, you can create your own default program by overwriting the **Default** file in the MX-Edit directory with the program of your choice.

The MX-Edit™ Program Editor

The MX-Edit Program Editor lets you quickly and easily view, compare and edit any program stored in the MX200, or programs saved to your computer.



MX-Edit gives you all the same control and functionality as the MX200 front panel, with the exception of **Input** control, **Audition**, and **Utility** functions. You'll also see that the **Routing** button has been replaced by a pull-down menu, as have the two **Effect Select** buttons. The **Active Reverb/Effects Matrix** and **Program Display** have been replaced by the Title Bar and values above the Parameter adjust knobs.

With these minor differences, the Program Editor works just like the MX200's front panel – and all changes that you make in the active Program Editor window are reflected in real-time on the MX200. MX-Edit and the MX200 are fully interactive, so any changes made on the MX200's front panel are reflected in real-time in the active MX-Edit Program Editor window as well.

When you open a program, an instance of the MX-Edit Program Editor appears, with the selected program's name in Program Name field. The settings of the loaded program are reflected in the Parameter knobs and buttons, and are loaded into the

MX200 hardware. The program (and any edits you make) can be previewed at any time by using the **Audition** button on the MX200 front panel.

You can have multiple Program Editors open at once, but only the currently selected window is active. In other words, MX200 processes the settings of the *active* Program Editor, and you only hear the settings of the active (selected) Program Editor window.

Editing a Program

Signal Routing Options

To change MX200's **Routing**, left click on the **Routing** button in the **Input/Routing** control area. A list of the MX200's four **Routing** options appears, with a check mark next to the currently selected routing. Highlight an item in the list and left click to select and load it. A routing diagram will appear next to the **Routing** button, and the routing name will be shown in the button.

Reverb/Effect Selection Buttons



Reverb/Effect Selection Buttons

To change a reverb or effect in Processor 1 or Processor 2, left click on the **Reverb/Effect Select** button in P1 or P2 control area. A list of the MX200's 32 reverbs and effects appears, with a check mark next to the currently selected reverb or effect. Highlight an item in the list and left click to select and load it. Notice that the reverb or effect name now appears in the **Reverb/Effect Select** button, and the Parameter knobs in MX-Edit change position depending on the default values for the selected reverb or effect.

Adjusting Knobs

To make editing in MX-Edit easy and intuitive, there are three ways to adjust knobs in MX-Edit:

Mouse – Circular

Place the cursor at the outer (shadowed) edge of a knob, then click and hold the left mouse button. The white indicator line on the knob jumps to the mouse cursor's position, and follows the cursor as it moves around the circumference of the knob. To make fine adjustments, continue to hold the left mouse button down and move the cursor away from the knob; the white line still follows the cursor, no matter how far away it is from the knob.

Mouse – Up / Down

Move the mouse cursor to the center of a knob; the knob is highlighted, and the cursor changes to a double-headed arrow, pointing up and down. Click and hold the left mouse button, causing the cursor to disappear. Move the mouse up to turn the knob higher, or move the mouse down to turn the knob lower. For very fast edits, press and hold the **Ctrl** key on your computer keyboard while moving the mouse; this multiplies the adjusted value by a factor of 10.

Arrow Keys

Highlight, then left-click on a knob to select it. Use the up (or right) arrow key to turn the knob higher and increase the value; use the down (or left) arrow key to turn the knob lower, decreasing the value. This is a very effective method for making small adjustments to fine-tune your settings. For faster modifications, press and hold the **Ctrl** key on your computer keyboard while pressing an arrow key to multiply each adjustment by a factor of 10.

Tempo

If one of the MX200's six delays is selected, the **Tempo** button in that processor becomes active, and begins to flash at the rate displayed above the **Time Range** knob. The tempo value is shown in milliseconds (ms), and a quarter-note appears next to the displayed tempo. When the **Time Range** parameter is adjusted, exact divisions of time in milliseconds relative to the flashing **Tempo** rate will cause a note value to be displayed next to the time, e.g. 16th note, dotted-8th note, etc. The **Tempo** button will continue to flash at the originally selected tempo, but the delay taps will occur at the rate displayed in the **Time Range** value.

To change the tempo value, simply place the mouse cursor over the **Tempo** button, and left-click twice to tap the tempo, just as you would on the MX200 front panel. The **Tempo** buttons on MX200 and in the Program Editor window now flash at the new tempo.

If something other than one of the six delays is loaded in the processor, the **Tempo** button is grayed out and inactive.

Bypass

To engage the **Bypass** button (and turn off the selected effect), place the mouse cursor over the **Bypass** button, and left-click to bypass that processor. Note that the **Bypass** buttons on both the MX200 front panel and the Program Editor illuminate to indicate the selected processor is bypassed.

Program Name

To create or change a program's name, simply left click once anywhere in the Program Name field. The program name will be highlighted; type the new name into the Title Bar. The program name in the Header area will not change until the program has been saved.

Saving a Program

If you make any changes to a program, an asterisk (*) will appear next to the program name in the Title Bar of the Program Editor. The LED associated with the corresponding knob or button and the Store button on the MX200's front panel also illuminates, indicating a change from the loaded program.

To save a program to disk, click **File** and select **Save** or **Save As**, and enter a file name. By default, programs are saved to your computer in the **My Documents** folder; to choose a different location, simply navigate to a different folder or create a new folder in which to save your MX200 program files. (For example, **C:\Documents and Settings\username\My Documents\MX200 Presets**). Click the **Save** button to complete the process.

You can also save a program simply by closing the active Program Editor window. If any changes have been made to the loaded program, a dialog box appears, asking if you want to save your changes. Click **Yes** to save the changes, **No** to close without saving, or **Cancel** to return to the active Program Editor window. If you choose this method to save your changes, the current program will be over-written; to save the program as a new file with a different name (and keep the loaded program's settings intact), click **File** then **Save As**.

MX200 programs are given the file extension **.m2p**, and they can be copied, moved, attached to emails – anything you can do with a standard document or file. These files should, however, only be opened by MX-Edit Editor/Librarian software to prevent corruption.

Storing a Program

To store a program into one of the 99 User program locations in the MX-Edit Library (and the corresponding location in the MX200's physical memory), open the program you wish to store. With the Program Editor window active, click **Device**, then **Store Program**. The **Store to Device** dialog appears, allowing you to choose the User program location and program name to store with it. Be aware that storing a program in this manner will over-write the program previously stored in that location, both in the MX-Edit Library and the MX200 itself. Click **Save** to store to the selected User program location. To cancel the operation, click **Cancel**, or close the **Store to Device** dialog box.

To rename a User program in the Library, right-click on its name in the Library window and select **Rename**. Type in the new name and press **Enter** to save the change.

Since the Factory programs can never be over-written, you cannot store to nor rename a Factory program location. You may edit a Factory program, but it must be stored to a User program location.

Archiving

Archiving is a powerful tool for preserving the current state of your MX200. When you archive the MX200, all of its presets and global settings are sent to the computer and saved to a file. When an archive is restored, the MX200 is configured exactly how it was when you archived it. This allows you to not only create safety backups, but create unique configurations for various purposes. For example, you might want to create a setup specifically for that gig you're playing on the weekend, but still keep all your favorite studio presets intact. Use MX-Edit's **Backup** feature to archive the MX200's settings, then modify and store anything and everything you want, without worrying about reprogramming all

your previous programs and settings.

To archive the MX200, click **Device** and select **Backup**. A warning will appear, advising you that a full Backup may take a few minutes, and asking whether you wish to proceed. To cancel without creating a Backup archive, click **Cancel** or close the dialog box. To proceed, click **OK**. A progress bar appears at the bottom of the MX-Edit screen, indicating that a Bulk Dump is in process. When all the MX200 data is received, a **Save** dialog box appears. The default file name is the current day and date (e.g. **Backup Wednesday, April 27, 2005**) with the file extension .m2a (MX200 Archive file). Click **Save** to store the Backup Archive file.

To restore a saved archive, click **Device** and select **Restore**. When prompted, select an MX200 archive file, and click **Open**. MX-Edit then sends the MX200 archive to your MX200, replacing all the data in the hardware with the archived data.

Note: It is a good idea to create a new Backup archive file anytime you plan to restore the MX200 from a previous archive session.

The MX-Edit™ Editor/Librarian - Mac

The included MX-Edit Editor/Librarian software lets you create, edit, save and load reverbs and effects programs for use with your MX200 on your Macintosh® OSX computer. While the MX200 has 99 User program locations, you can create and save as many programs you like on your computer, and load them into your MX200 via a USB connection at any time.

Minimum System Requirements

Before installing the MX-Edit Editor/Librarian software, make sure that your computer meets the following minimum requirements:

OSX 10.3 or higher

Installing the MX-Edit Editor/Librarian

To install the MX-Edit, VST™ and Audio Units software for Macintosh® computers, insert the provided disc into the CD-ROM drive and double-click on the disc icon when it appears. Double-click on the **MX200.dmg.hqx** file to extract and run the installer. Follow the on-screen prompts to install the software.

The installer sets up the standalone **MX-Edit Editor/Librarian** application in the Applications folder, the **MX-Edit Audio Unit** in the Components folder, and the **MX-Edit VST** in the VST folder.

Quick Start

When you first start MX-Edit, the MX-Edit Program Editor window opens.



To load a program, click the Program Menu field. A list of programs appears.

Program Menu Field



Select a program in the list to load it.

Make your adjustments (if any) to the knobs and buttons in the control panel just as you would on the MX200 itself.

If you want to save your edits to a file, select **File > Save** menu or **File > Save As**. The **Save** dialog box appears; type a name in the **Name:** field and click **OK**.

The MX-Edit Program Window



The Program Editor window lets you conveniently view and edit a program. The Program Editor window contains a header section that includes the Program Name.

To open a program from the MX200 click in the Program Menu field and select a program from the list.

To open a saved program from a file, select **File > Open Program**. When the **Open** dialog box appears, browse to find the program, and double-click the program name to load it.

To save a program to disk, select **File > Save Program** or **Save Program As**, enter a file name, then click the **Save** button.

The MX-Edit Editor/Librarian - Mac

To store a program into one of the MX200's 99 User program locations, select **Device > Store Program**, choose the location and program name, then click the **Save** button.

You can create new programs based either on the User or Factory programs, but you may only store to User program locations. As in the MX200 hardware, Factory programs cannot be over-written.

To rename a User program, select **Device > Rename**. Enter a new name, select the User program location, and press **Enter**.

Editing a Program

Signal Routing Options

To change MX200's **Routing**, click on the **Routing** button in the **Input/Routing** control area. A list of the MX200's four **Routing** options appears; highlight an item in the list and click to select it. A routing diagram appears next to the **Routing** button, and the routing name is shown in the button.

Reverb/Effect Selection Buttons



Reverb/Effect Selection Buttons

Click on a **Reverb/Effect Select** button to open a list of the MX200's reverbs and effects. Select an item in the list to load it. Notice that the reverb or effect name now appears in the **Reverb/Effect Select** button, and the Parameter knobs in MX-Edit change position depending on the default values for the selected reverb or effect.

Adjusting knobs

Move the cursor to the center of a knob. Click and hold the mouse button.

Move the mouse up (or right) to turn the knob higher; move the mouse down (or left) to turn the knob lower. For fine adjustments, hold the **Option** key while moving the mouse.

Tempo

If one of the MX200's six delays is selected, the **Tempo** button in that processor becomes active, and begins to flash at the rate displayed above the **Time Range** knob. The tempo value is shown in milliseconds (ms), and a quarter-note appears next to the displayed tempo. When the **Time Range** parameter is adjusted, exact divisions of time in milliseconds relative to the flashing **Tempo** rate will cause a note value to be displayed next to the time, e.g. 16th note, dotted-8th note, etc. The **Tempo** button will continue to flash at the originally selected tempo, but the delay taps will occur at the rate displayed in the **Time Range** value.

To change the tempo value, simply place the mouse cursor over the **Tempo** button, and left-click twice to tap the tempo, just as you would on the MX200 front panel. The **Tempo** buttons on MX200 and in the Program Editor window now flash at the new tempo.

If something other than one of the six delays is loaded in the processor, the **Tempo** button is grayed out and inactive.

Bypass

To engage the **Bypass** button (and turn off the selected effect), place the mouse cursor over the Bypass button, and click to bypass that processor. Note that the Bypass buttons on both the MX200 front panel and the Program Editor illuminate to indicate that the selected processor is bypassed.

Archiving

Archiving is a powerful tool for preserving the current state of your MX200. When you archive the MX200, all of its presets and global settings are sent to the computer and saved to a file. When an archive is restored, the MX200 is configured exactly how it was when you archived it. This allows you to not only create safety backups, but create unique configurations for various purposes. For example, you might want to create a setup specifically for that gig you're playing on the weekend, but still keep all your favorite studio presets intact. Use the MX-Edit **Backup** feature to archive the MX200's settings, then modify and store anything and everything you want, without worrying about reprogramming all your previous programs and settings.

To archive the MX200, select **File > Backup**. In the dialog box, select a name and location for the archive file. The default name and location is **untitled.syx** on your Desktop.

To restore an archive, select **File > Restore**. Select an archive file to be restored, then wait for the data to be received by the device. MX-Edit sends the archive information to your MX200, replacing all the data in the hardware with the archived data.

Note: It is a good idea to create a new **Backup** archive file anytime you plan to restore the MX200 from a previous archive session.

Quick Access Menu

For instant access to the most often used commands, click the small down arrow in the upper left corner of the program window to open the Quick Access Menu.

Quick Access Menu



Store Program in MX200

Lets you choose a name and location in the library for the selected program.

Rename Program in MX200

Lets you select a User program and rename it.

Open Program

Lets you browse for and open existing programs.

Save Program

Saves the selected program window under its current name. (If the program is untitled, you will be prompted to name it.)

Backup

Creates an archive of the programs saved in the MX200.

Restore

Lets you browse for and open an MX200 Archive File, which loads archived programs onto the MX200.

Using the MX200 as a Hardware Plug-In

The MX200 comes with VST™ and Audio Units software which allows you to use the MX200 as a Hardware Plug-In. Now you have access to classic Lexicon® reverbs and effects within your software recording projects, with full automation and total recall, without burdening your CPU! Using the MX200 with the VST and Audio Units software works much like any other plug-in you'd use with a DAW, except that the audio is routed through the MX200 for the signal processing.

Minimum System Requirements

Audio

I/O hardware with a **minimum** of two inputs and four audio outputs.

Windows

P-III, 500MHz or better, WinXP Service Pack 2 or higher plus a VST-compatible Software Recording Package

Mac

OSX 10.3 or higher plus a VST™ or Audio Units compatible Software Recording Package

Installing the MX-Edit VST Hardware Plug-In

Note: If you have already installed the MX-Edit™ software for Mac or WinXP, you have already installed the VST and/or Audio Units software. Simply skip this section.

For Windows XP users

To install the software in Windows, insert the disc into your CD-ROM drive and follow the on-screen prompts. (If the Autorun feature is disabled, browse to the CD and double-click on the setup.exe file.)

For Mac users

To install on a Mac, insert the disc into your CD-ROM drive and double-click on the disc icon when it appears. Double-click on the MX200.dmg.hqx file to extract and run the installer. Follow the on-screen prompts to install the software.

Connecting the MX200

USB Connection

Make sure the MX200 is powered up and connected to your computer with a standard USB cable. (For Windows XP users, make sure the MX200 is plugged into the same USB port as when the software was loaded.)

Audio Connections

To use the MX200 as a hardware plug-in, your computer needs audio hardware with multiple audio inputs and outputs available, at least enough to send and return two channels from the MX200 plus two additional outputs to monitor with.

For lower latencies and the best audio performance, it is recommended that you connect the MX200 to your computer's audio I/O device using the S/PDIF Inputs and outputs. If your I/O device does not have a S/PDIF connection, or if it already connected to another device, you may use the analog connections from your computer's I/O device to the 1/4" analog inputs and outputs on the MX200.

Important: The MX200 accepts digital audio at 44.1kHz and 48kHz sample rates. Do not connect any digital device to the MX200's S/PDIF Input that transmits at any other sample rate (such as 96kHz). Doing so can cause unpredictable performance. Make sure your recording project is set to either 44.1kHz or 48kHz sample rate to avoid problems.

Software Configuration

Because the audio is being processed within the MX200 hardware, and not inside your computer, your DAW (Digital Audio Workstation, or Recording Software) needs to be set up to send and receive audio to and from the MX200.

Many DAW's have built-in routing configurations for this; consult your software's documentation for information about setting up external routing options.

Steinberg® Cubase SX® users: see information on "External FX" connections.

Logic® Audio users: see information about "I/O Insert Plug-Ins."

Cakewalk® Sonar™ users: see information about "Adding Send / Return Effects to a Bus"

If your software does not provide specific information about these types of configurations, you can set up the connections yourself. Each recording platform will vary slightly, but the basic principles are the same.

To set up a send and return path:

1. Create a Stereo Bus (or two audio busses) that are different from your Main Mix (Master) Bus.
2. Route these busses to the outputs on your audio I/O hardware that you have connected to the MX200 (Either the S/PDIF output, or two analog outputs).
3. In your VST or Audio Units Send Effects Routing options, send the MX200's effect sends to the Stereo Busses (or Bus Pair) you created in Step 1.
4. Create two audio tracks whose inputs correspond to those you connected to the MX200 (Either the S/PDIF input, or two analog inputs).
5. Route these tracks to the Main Mix (Master) Bus.

If you have followed these steps correctly, when you open an instance of the MX200 plug-in, its audio path will lead it to the bus pair you created, which will send the audio to the MX200. The processed audio is then sent from the MX200 through your audio hardware's inputs to the two audio tracks you created in Step 4, and monitored through the Main Mix Bus, just as you would any audio or plug-in effect.

Using the MX200 Plug-In Window

In your DAW, open the Lexicon MX200 plug-in. You'll see an instance of the Program Editor window. You can use the MX200 plug-in software just as you would any other plug-in: Session Recall, automation – everything behaves just as any other VST™ or Audio Unit plug-in. The primary difference is that the audio processing occurs in the MX200 rather than on your computer. And, since the MX200 is a physical device, you can only open one instance of the plug-in window. If you attempt to open more than one plug-in window, the message shown below will appear.



Controls

The MX200's Plug-In window functions much like the MX-Edit Program Editor window described on page 28.

Using MIDI with the MX200

CC Mapping

Processor 1 Effect Type	CC 12
Processor 1 Bypass	CC 13
Processor 1 Pre Delay Knob	CC 14
Processor 1 Decay Knob	CC 15
Processor 1 Liveliness Knob	CC 16
Processor 1 Tempo	CC 17
Processor 1 Effect Mix	CC 26
Processor 2 Effect Type	CC 19
Processor 2 Bypass	CC 20
Processor 2 Pre Delay Knob	CC 21
Processor 2 Decay Knob	CC 22
Processor 2 Liveliness Knob	CC 23
Processor 2 Tempo	CC 24
Processor 2 Effect Mix	CC 27
Effect Routing	CC 28

Important! MIDI Port Error Message



If you see this message, the MX200 is either disconnected or its USB MIDI ports are in use by an application. Some hosts, such as Cubase, may automatically open the MX200's MIDI ports by default. In this case, you will need to deselect or disable the port named "Lexicon MX200 Control" in the application's MIDI Devices setup.

MIDI Implementation Chart

Function		Transmitted	Recognized	Remarks
Basic Channel	Default	X	1	
	Changed	X	1-16, Omni, Off	
Mode	Default		Mode 2	
	Messages Altered	X	X	
Note Number	True Voice	X	X	
Velocity	Note ON	X	X	
	Note OFF	X	X	
After Touch	Keys	X	X	
	Channels	X	X	
Pitchbend		X	X	
Control Change		X	1-127	See MIDI CC list
Program Change	True #	X	0-98 = 1-99	See Program mapping
	Bank Select	X	0	MIDI CC 32 Value 0 = Factory, Value 1 = User
System Exclusive		0	0	Lexicon Editor Only. Sys Ex channel follows MIDI channel except when MIDI channel is set to Off, where Sys Ex channel then receives on all channels.
System Common	Song Position:	X	X	
	Song Select:	X	X	
	Tune:	X	X	
System Real Time	Clock:	X	0	MIDI clock can set Delay Tempo
	Commands:	X	X	
Aux Messages		X	X	

0 = Yes
X = No

Mode 1: OMNI ON, POLY
Mode 3: OMNI OFF, POLY

Mode 2: OMNI ON, MONO
Mode 4: OMNI OFF, MONO











Specifications

Audio Inputs:	(2) 1/4" TRS balanced or unbalanced
Input Impedance:	20k Ohms balanced, 10k Ohms unbalanced
Input Level:	+4dBu Nominal, +20dBu Maximum
Frequency Response:	20 Hz - 20kHz, ref. 1kHz +/- 1dB
THD+N:	<.007% 20Hz - 20kHz
Line Outputs:	(2) 1/4" TRS balanced or unbalanced
Output Level:	+4dBu Nominal, +20dBu Maximum
Dynamic Range:	>108dB
A/D Converters:	24-bit, 48kHz
Power:	9V DC (power supply included)
Audio Processor:	24-bit
Software:	WinXP/Mac OSX VST GUI Interface
Size:	1 RU
Dimensions:	19" W x 1.75" H x 4.75" D
Weight:	3.75 lbs.

Appendix

Delay

Time Range Values

Value	Notation	Note Value
0		sixteenth note
4		triplet sixteenth
6		dotted sixteenth
12		eighth note
20		triplet eighth
24		dotted eighth
36		quarter note
48		triplet quarter
54		dotted quarter
72		half note

Note: A value of 36 is the 12 o'clock knob position, or equal to the **Tempo LED** rate. Intermediate values (e.g. 1-3) do not represent exact note values.

De-Esser

Frequency Values

Display Value	Frequency (Hz)
1	1600
2	1680
3	1760
4	1840
5	1920
6	2000
7	2100
8	2200
9	2300
10	2400
11	2500
12	2630
13	2760
14	2890
15	3020
16	3150
17	3320
18	3490
19	3660
20	3830
21	4000
22	4200
23	4400
24	4600
25	4800
26	5000
27	5260
28	5520
29	5780
30	6040
31	6300
32	6640
33	6980
34	7320
35	7660
36	8000
37	8400
38	8800
39	9200
40	9600
41	10000

Bandwidth Values

Value	Bandwidth
1	1/4 Oct
2	1/8 Oct
3	1/12 Oct
4	1/16 Oct
5	1/20 Oct
6	1/24 Oct

Program List

Program #	Title	Application	P1	P2	Routing
1	BIG POP VOCAL	Vocal	Studio Delay	Vocal Hall	2
2	POP VOCALS	Vocal	Tape Delay	Studio Reverb	3
3	RETROVERB	Vocal	Tape Delay	Vocal Plate	2
4	CHORUS + PLATE	Vocal	Chorus	Plate	4
5	VOCAL HALL+PLATE	Vocal	Vocal Hall	Vocal Plate	4
6	EXTRA ROOMY	Live Sound	Room	Small Hall	2
7	TUNED ROOM	Live Sound	Detune	Room	2
8	ECHOVERB	Live Sound	Digital Delay	Small Hall	2
9	QUICKIE	Live Sound	Small Hall	Digital Delay	2
10	ACOUSTIC CHAMBER	Instrumental	<i>Tape Delay</i>	Chamber	2
11	AMBIENT CHAMBER	Instrumental	Ambience	Chamber	4
12	ACOUSTIC BLISS	Instrumental	Detune	Large Hall	4
13	GUITAR WORLD	Instrumental	Chorus	Modulated Delay	2
14	SPRINGTIME	Instrumental	<i>Tremolo/Pan</i>	Spring	2
15	GIANT SNARE	Drums & Percussion	Studio Delay	Drum Hall	2
16	SMOOTH DRM PLATE	Drums & Percussion	Compressor	Drum Plate	2
17	RICH DRUM HALL	Drums & Percussion	Compressor	Drum Hall	2
18	BIG TIME	Special	Digital Delay	Large Hall	4
19	VOICE OF EVIL	Special	Pitch Shifter	Reverse Reverb	2
20	WAYBACK MACHINE	Special	Reverse Delay	Reverse Reverb	2
21	BIG VOCAL VERB	Vocal	Large Plate	Vocal Hall	2
22	TWO ROOMS	Vocal	Small Hall	Vocal Hall	1
23	BIG EASY	Vocal	Chorus	Vocal Hall	2
24	NASHVILLE	Vocal	Vocal Plate	Room	4
25	LA-LA LAND	Vocal	Compressor	Vocal Hall	2
26	SMOOTH VOCALS	Vocal	Compressor	Small Hall	2
27	COMPRESSED VOX	Vocal	Compressor	Vocal Hall	2
28	NO "S" VOCALS	Vocal	De-Esser	Vocal Plate	2
29	DE-ESSER+COMPR	Vocal	De-Esser	Compressor	2
30	COMPRESSOR	Vocal	Compressor	<i>Compressor</i>	4
31	DE-ESSER	Vocal	De-Esser	<i>De-Esser</i>	4
32	STUDIO DELAY	Vocal	Studio Delay	<i>Vocal Hall</i>	2
33	60'S DELAY	Vocal	Tape Delay	Spring	2
34	SLAPBACK	Vocal	<i>Detune</i>	Tape Delay	2
35	DELAY + VERB	Vocal	Studio Delay	Vocal Hall	1
36	VOCAL CHORUS	Vocal	Chorus	<i>Vocal Hall</i>	2
37	CHORAL HALL	Vocal	Chorus	Large Hall	2
38	TAPE CHOURUS	Vocal	Tape Delay	Chorus	2
39	CORE US	Vocal	Chorus	Chorus	1
40	DOUBLE TRACKS	Vocal	Detune	Chorus	2
41	SHIFTED ROOM	Vocal	Pitch Shift	Room Reverb	3
42	LIKE THAT!	Vocal	Pitch Shifter	Vocal Hall	4
43	PLATE + HALL	Live Sound	Vocal Plate	Small Hall	1
44	VOCAL + INST 1	Live Sound	Vocal Hall	Studio	4
45	VOCAL + INST 2	Live Sound	Vocal Plate	Detune	4
46	VOCAL + INST 3	Live Sound	Vocal Hall	Small Hall	4
47	GET SMALL	Live Sound	Small Hall	Small Plate	4
48	ALIVE N' KICKING	Live Sound	Small Hall	Studio	4
49	MUY GRANDE	Live Sound	Drum Hall	Digital Delay	4
50	BIGGER BAND	Live Sound	Chorus	Studio Delay	2

Effects in the list that are italicized and shaded are in Bypass in the factory programs.
Effects that are bolded are designed to be Full Wet only (e.g. Compressor).

Program List

Program #	Title	Application	P1	P2	Routing
51	TAPS	Live Sound	Chorus	Tape Delay	2
52	TAP CHAMBER	Live Sound	Pong Delay	Chamber	2
53	SPACED OUT	Live Sound	Large Plate	Modulated Delay	2
54	DUAL HALLS	Instrumental	Large Hall	Small Hall	1
55	TRIED AND TRUE	Instrumental	Studio	Small Hall	4
56	MORE & MORE	Instrumental	Large Plate	Arena	4
57	SPRING STUDIO	Instrumental	Spring	Studio	4
58	HIT ME	Instrumental	Tape Delay	Studio	2
59	PRECISION DELAY	Instrumental	Digital Delay	Small Hall	2
60	MODULATED DELAY	Instrumental	Chorus	Modulated Delay	2
61	ROCK LEAD	Instrumental	Tape Delay	Small Plate	4
62	PONG VERB	Instrumental	Small Plate	Pong Delay	2
63	MOD-U-VERB	Instrumental	Vocal Plate	Chorus	2
64	ROTO-VERB	Instrumental	Drum Hall	Rotary Speaker	2
65	ROTARY	Instrumental	Rotary	Small Room	4
66	HAM 'N EGGS	Instrumental	Tape Delay	Rotary	2
67	VIBROLUX	Instrumental	Rotary Speaker	Spring	1
68	SIDE BY SIDE	Instrumental	Tremolo	Panner	4
69	WOBLERS	Instrumental	Chorus	Small Plate	4
70	RHODES PANNER	Instrumental	Phaser	Tremolo/Panner	4
71	BREWED AWAKENING	Instrumental	Flanger	Tape Delay	1
72	JET FLANGE	Instrumental	Flanger	Arena	2
73	PHASE GATE	Instrumental	Gated	Phaser	4
74	PHASED PLATE	Instrumental	Phaser	Small Plate	2
75	PHAME	Instrumental	Phaser	Large Plate	1
76	PHASER TASER	Instrumental	Phaser	Digital Delay	2
77	DUALING GUITARS	Instrumental	Pitch Shifter	Pitch Shifter	4
78	THE LOW DOWN	Instrumental	Pitch Shift	Modulated Delay	1
79	AND THEN SOME	Instrumental	Reverse Delay	Tremolo	2
80	SQUISHED KICK	Drums & Percussion	Compressor	Drum Hall	2
81	GATED SNARE	Drums & Percussion	Gated Reverb	Gated Reverb	3
82	SNARE DELAY	Drums & Percussion	Studio Delay	Drum Plate	2
83	DRUM DELAY	Drums & Percussion	Tape Delay	Drum Hall	2
84	DRUM ECHO	Drums & Percussion	Tape Delay	Small Hall	2
85	TEMPO GATE	Drums & Percussion	Studio Delay	Gated	2
86	FLANGE DRUMS	Drums & Percussion	<i>Studio Delay</i>	Flanger	2
87	TOM-TOM	Drums & Percussion	Studio Delay	Drum Hall	4
88	SNARE + TOMS	Drums & Percussion	Drum Hall	Room	4
89	DRUM PLATE/HALL	Drums & Percussion	Drum Plate	Drum Hall	4
90	VIBRATO	Special	Vibrato	Vibrato	4
91	VIBRA-SLAP	Special	Vibrato	Digital Delay	1
92	SPIN CYCLE	Special	Rotary	Tremolo/Panner	2
93	ROLE REVERSAL	Special	TremoloPan	Reverse	2
94	GET SOME	Special	Flanger	Reverse Delay	3
95	REWIND	Special	Chamber	Reverse	2
96	BACK AT YA	Special	Reverse Delay	Reverse	4
97	DELAY WARS	Special	Pong Delay	Modulated Delay	4
98	PITCH OUT	Special	Pitch Shifter	Pong Delay	2
99	HUH?	Special	Pitch Shifter	Vocal Plate	2

Effects in the list that are italicized and shaded are in Bypass in the factory programs.
Effects that are bolded are designed to be Full Wet only (e.g. Compressor).

Lexicon®

10653 S. River Front Parkway, Suite 300
South Jordan, UT 84095

PH: (801) 566-8800

FAX: (801) 566-7005

WEB: www.lexiconpro.com

Printed in China

Lexicon MX200 Owners Manual 5073493-B

© 2016 HARMAN International Industries, Incorporated.

All rights reserved.