



KRAMER ELECTRONICS LTD.

USER MANUAL

MODEL:

VP-728

Presentation Switcher/Scaler

P/N: 2900-000363 Rev 9



VP-728 Quick Start Guide

This guide helps you install and use your product for the first time. For more detailed information, go to http://www.kramerelectronics.com/support/product_downloads.asp to download the latest manual or scan the QR code on the left.

Step 1: Check what's in the box

- The **VP-728** Presentation Switcher Scaler
- 2 C-SF/2RVM cables
- IR remote control transmitter with batteries
- 1 Null-modem adapter
- 1 Set of rack ears
- 4 Rubber feet
- 1 Power cord
- 1 Quick start guide

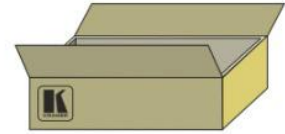

Save the original box and packaging materials in case you need to return your product for service.

Step 2: Install the VP-728

Mount the machine in a rack or place on a table.

Step 3: Connect inputs and outputs

Always switch OFF the power on each device before connecting it to your **VP-728**.

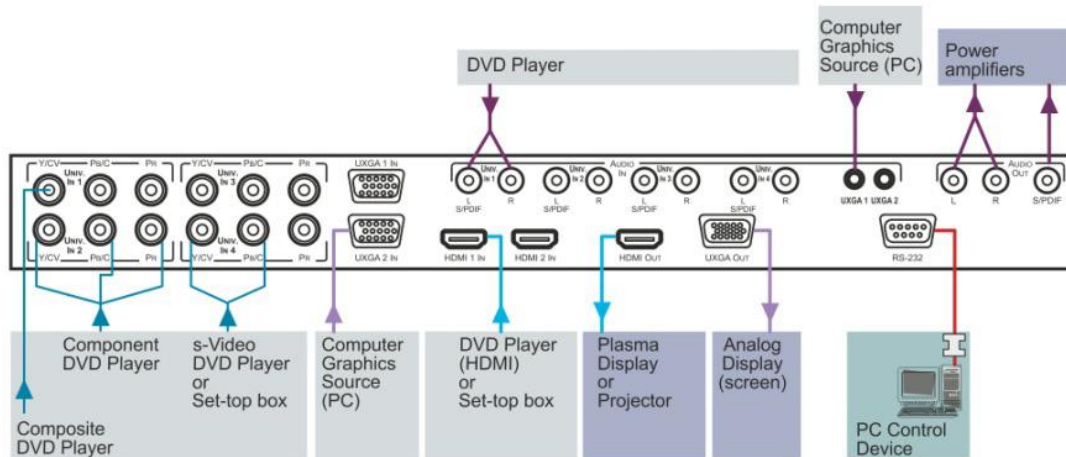

For best results, we recommend that you always use Kramer high-performance cables to connect AV equipment to the **VP-728**.

Step 4: Connect the power

Connect AC power to the rear of the **VP-728**, switch on its power and then switch on the power on each device.



Step 5: Operate via the front panel buttons and the remote control transmitter

Push the MENU button to access the menu and show the main menu screen on your display or projector.

If you cannot see any images, verify that the output cable to your display, TV, or projector is in good working order and is connected to the **VP-728**.

If you still don't see an image, press and hold the RESET TO XGA/720P button for a second to reset the output to XGA (1024x768) resolution. Push the MENU button again and the main menu should appear on the screen.

Press an input button. The **VP-728** will quickly fade to black, switch inputs, and then fade up from black to show the new input signal on your display or projector.

Press and hold to reset to the default resolution (helpful if you fail to see the input signal on the display)

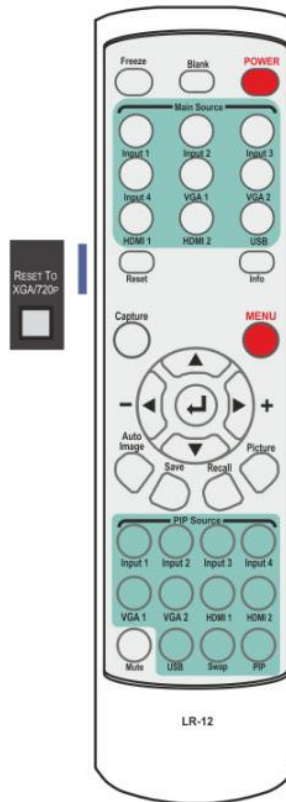

POWER
Cycles power



Press one of the nine Main Source buttons to select an input signal



The MENU button shows the main OSD menu. The arrow buttons and ENTER button let you navigate within the OSD menu

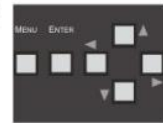

Step 6. Set the inputs

Universal Inputs: by default, the UNIVERSAL inputs are set to CV. To change the default setting, select a different input via the Input OSD menu.

UXGA inputs: you do not have to set the UXGA inputs

HDMI Inputs: set HDCP support via the Setup OSD menu

USB Input: read JPEG picture files (up to 2048x1536 and not exceeding 1MB) to use as a logo, background or to create a slideshow

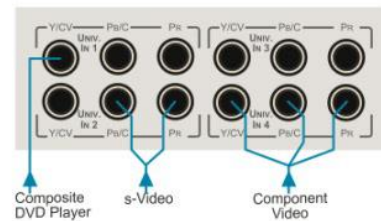

Step 7: Set the output resolution



The **VP-728** is set at the factory to a default output resolution of 1024x768 (XGA) with a refresh rate of 60Hz.

If your projector or display uses XGA resolution, you can start using the **VP-728**. If not, you can set a different output resolution via the Output OSD menu.

Contents

1	Introduction	1
2	Getting Started	2
2.1	Achieving the Best Performance	2
2.2	Recycling Kramer Products	2
3	Overview	3
3.1	Defining the VP-728 Presentation Switcher/Scaler	5
4	Installing in a Rack	9
5	Connecting the VP-728	10
5.1	Connecting a PC	13
6	Presentation Switcher / Scaler Buttons	14
6.1	Switching an Input	14
6.2	The PIP Button Feature	15
6.3	Locking and Unlocking the Front Panel	19
6.4	The Infrared Remote Control Transmitter	20
7	Configuring the VP-728 via the OSD MENU Screens	21
7.1	The Input Screen	22
7.2	The Picture Screen	24
7.3	The Output Screen	25
7.4	The PIP Screen	27
7.5	The Audio Screen	28
7.6	The Geometry Screen	29
7.7	The Setup Screen	30
7.8	The Advanced Setup Screen	32
7.9	The Info Screen	37
8	Using Text Overlay	38
9	Audio Flash Memory Upgrade	40
9.1	Downloading from the Internet	40
9.2	Connecting the PC to the RS-232 Port	41
9.3	Upgrading the Audio Firmware	41
10	Technical Specifications	46
11	VP-728 Communication Protocol	51
11.1	Error Codes Description	62

Figures

Figure 1: VP-728 Presentation Switcher/Scaler Front Panel	6
Figure 2: VP-728 Presentation Switcher/Scaler Rear Panel	8
Figure 3: Connecting to the VP-728 Rear Panel	12
Figure 4: Crossed Cable RS-232 Connection	13
Figure 5: Straight Cable RS-232 Connection with a Null Modem Adapter	13
Figure 6: PIP Source over Background	16
Figure 7: The SWAP Status	17
Figure 8: IR Remote Control Transmitter	20
Figure 9: MENU Items	21
Figure 10: Input Screen	22
Figure 11: Picture Screen	24
Figure 12: Output Screen	25
Figure 13: PIP Screen	27
Figure 14: Audio Screen	28
Figure 15: Geometry Screen	29
Figure 16: Setup Screen	30
Figure 17: Advanced Setup Screen	32
Figure 18: Misc Screen	33
Figure 19: Input Functions	35
Figure 20: Output Functions	36
Figure 21: Active Video Functions	37
Figure 22: Information Screen	37
Figure 23: Text Overlay Application Screen	38
Figure 24: Splash Screen	41
Figure 25: Atmel – Flip Window	42
Figure 26: Device Selection Window	42
Figure 27: Selecting the Device Window	43
Figure 28: Loading the Hex	43
Figure 29: RS-232 Window	44
Figure 30: Atmel – Flip Window (Connected)	44
Figure 31: Atmel – Flip Window (Operation Completed)	45

1 Introduction

Welcome to Kramer Electronics! Since 1981, Kramer Electronics has been providing a world of unique, creative, and affordable solutions to the vast range of problems that confront the video, audio, presentation, and broadcasting professional on a daily basis. In recent years, we have redesigned and upgraded most of our line, making the best even better!

Our 1,000-plus different models now appear in 11 groups that are clearly defined by function: GROUP 1: Distribution Amplifiers; GROUP 2: Switchers and Routers; GROUP 3: Control Systems; GROUP 4: Format/Standards Converters; GROUP 5: Range Extenders and Repeaters; GROUP 6: Specialty AV Products; GROUP 7: Scan Converters and Scalers; GROUP 8: Cables and Connectors; GROUP 9: Room Connectivity; GROUP 10: Accessories and Rack Adapters and GROUP 11: Sierra Products.

Congratulations on purchasing your Kramer **VP-728** *Presentation Switcher / Scaler*, which is ideal for the following typical applications:

- Projection systems in conference rooms, boardrooms, auditoriums, hotels and churches, production studios, rental and staging
- Any application where high quality conversion and switching of multiple and different video signals to graphical data signals is required for projection purposes

2 Getting Started

We recommend that you:

- Unpack the equipment carefully and save the original box and packaging materials for possible future shipment
- Review the contents of this user manual
- Use Kramer high performance high resolution cables
- Use only the power cord that is supplied with this machine



Go to <http://www.kramerelectronics.com> to check for up-to-date user manuals, application programs, and to check if firmware upgrades are available (where appropriate).

2.1 Achieving the Best Performance

To achieve the best performance:

- Use only good quality connection cables to avoid interference, deterioration in signal quality due to poor matching, and elevated noise levels (often associated with low quality cables)
- Do not secure the cables in tight bundles or roll the slack into tight coils
- Avoid interference from neighboring electrical appliances that may adversely influence signal quality
- Position your Kramer **VP-728** away from moisture, excessive sunlight and dust

2.2 Recycling Kramer Products

The Waste Electrical and Electronic Equipment (WEEE) Directive 2002/96/EC aims to reduce the amount of WEEE sent for disposal to landfill or incineration by requiring it to be collected and recycled. To comply with the WEEE Directive, Kramer Electronics has made arrangements with the European Advanced Recycling Network (EARN) and will cover any costs of treatment, recycling and recovery of waste Kramer Electronics branded equipment on arrival at the EARN facility. For details of Kramer's recycling arrangements in your particular country go to our recycling pages at <http://www.kramerelectronics.com/support/recycling/>.

3 Overview

The Kramer **VP-728** is a 9-input Proscale™ Presentation Switcher / Scaler with unbalanced stereo and digital S/PDIF audio. The **VP-728** scales any composite, s-Video (Y/C), component video (YUV), HDMI or computer graphics video signal, as well as JPEG files (via USB) up or down to a selectable graphics or HDTV output resolution. It also provides glitch-free switching between sources through FTB™ (fade-thru-black) switching technology, in which the video fades to black and then the new input fades from black for glitch-free and smooth switching. The output signal provides constant sync so the display never glitches. The output signal is available simultaneously on a 15-pin HD computer graphics video (UXGA) connector and on an HDMI connector.

The **VP-728** features include:

- Silicon Optix HQV® Video Processing - HQV (Hollywood Quality Video) processing represents the state-of-the-art in video processing technology, with the highest quality de-interlacing, noise reduction, and scaling performance for both standard-definition and high-definition signals
- K-IIT XL™ Picture-in-Picture Image Insertion Technology - ultra stable picture-in-picture, picture-and-picture, and split screen capability. Any video source can be inserted into or positioned next to a computer graphics video source or vice versa with window positioning and sizing controls
- Four user definable (universal) video inputs (each can be set as composite video, s-Video (Y/C) or component video), two computer graphics video inputs, two HDMI inputs and 1 USB input (for reading JPEG picture files that are recognized up to 2048x1536 and do not exceed 1MB)
- HDTV compatible component input
- HDTV output resolutions - 720p 1080i, and 1080p
- Scaled video outputs - HDMI and computer graphics video
- HDMI support of up to 2.25Gbps bandwidth per graphic channel
Suitable for resolutions up to UXGA at 60Hz, and for all HD resolutions
- Multiple computer graphics output resolutions - including a user-defined output resolution with selectable refresh rates

- Multiple aspect ratio selections
- Companion AFV (audio-follow-video) for every analog video input
- Embedded audio on the two HDMI inputs and output
The embedded audio feature is not available for the **RGB** resolutions 1920x1200 and 1920x1080. (It is available for 1080p)
- Built-in noise reduction and picture enhancement features
- Audio inputs - four (stereo audio or S/PDIF on two RCA connectors) for each of the four universal video inputs; two unbalanced stereo audio (on 3.5mm mini jacks) for the two computer graphics video inputs; and embedded audio on the HDMI inputs
- Audio outputs - S/PDIF and unbalanced stereo audio (RCA connectors). The machine transcodes stereo or S/PDIF audio to both stereo and S/PDIF audio and embeds audio into the HDMI output
Tip: To use a 5.1 digital audio source, connect this HDMI or S/PDIF source (for example, a Blu-ray player) directly to your receiver or display
- Built-in Time Base Corrector - stabilizes video sources with unstable sync
- Built-in video Proc-Amp - color, hue, sharpness, contrast, and brightness are set individually for each input
- A BLANK button, a FREEZE button, a RESET TO XGA/720P button (to hardware-reset the output resolution); and a PANEL LOCK button
The front panel blank, freeze and lock buttons can be programmed via the OSD menu (see [Page 34](#))
- Built-in audio Proc-Amp with bass, treble, balance and loudness control, as well as audio delay
- Firmware upgrade performed via the USB port
- Slideshow option, letting you run a slideshow via the USB port
- An OSD (On-Screen Display) – for making adjustments – that can be located anywhere on the screen

In addition, the **VP-728**:

- Includes non-volatile memory that retains the last settings, after switching the power off and then on again
- Digitally reprocesses the signal to correct mastering errors and regenerates the video at a higher line and pixel rate format, providing native-resolution video for LCD, DLP and plasma displays
- Is specifically designed to improve video quality by reducing chroma noise
- Scales and zooms (to up to 400% of the original size)
- Can provide non-linear scaling for 4:3 and 16:9 transformation

Control your **VP-728** directly via the front panel push buttons, or:

- By RS-232 serial commands transmitted by a touch screen system, PC, or other serial controller
- Remotely, from the infrared remote control transmitter (with on-screen menus)

The **VP-728** is housed in a 19" 1U rack mountable enclosure, with rack "ears" included and is fed from a 100-240 VAC universal switching power supply.

3.1 Defining the VP-728 Presentation Switcher/Scaler

This section defines the **VP-728**.

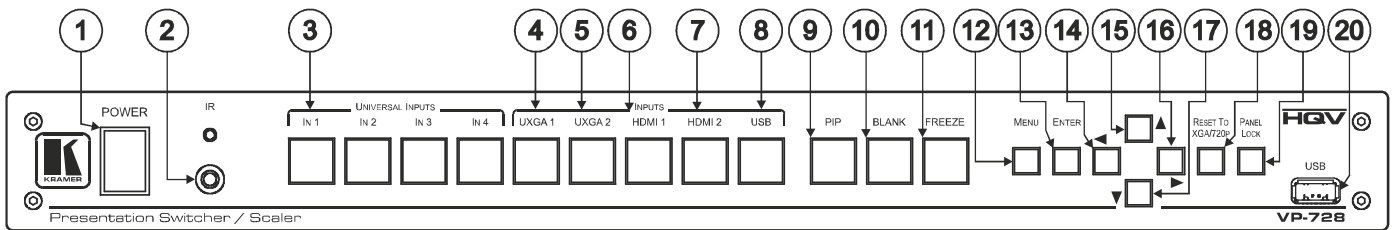

Figure 1: VP-728 Presentation Switcher/Scaler Front Panel

#	Feature	Function
1	POWER Switch	Illuminated switch for turning the machine ON or OFF
2	IR Receiver / LED	Lights red when the unit accepts IR remote commands
3	UNIVERSAL INPUT Selector Buttons	Press to select the composite video / s-Video / component video source and the appropriate audio source (from 1 to 4)
4	INPUT Selector Buttons (illuminates when selected)	UXGA 1 Press to select the UXGA source 1 and the appropriate audio source
5		UXGA 2 Press to select the UXGA source 2 and the appropriate audio source
6		HDMI 1 Press to select the HDMI source 1
7		HDMI 2 Press to select the HDMI source 2
8	USB	Press to select the USB source (JPEG files on a USB memory stick) and also run/stop the slideshow (see Section 7.7.1)
9	PIP Button	Toggles the picture-in-picture function (see Section 6.2)
10	BLANK Button	Press to toggle between a blank screen (blue or black) and the display. The BLANK button can be programmed to mute the audio signal at the same time (see Page 34)
11	FREEZE Button	Press to freeze/unfreeze the output video image, as well as pause the slideshow (see Page 31). The FREEZE button can be programmed to mute the audio signal at the same time (see Page 34)
12	MENU Button	Press to display the OSD menu screen. Press again to return to normal operation.
13	ENTER Button	Press to move to the next level in the OSD screen or to accept a new parameter
14	◀ Button	Decreases the range by one step in the OSD screen or moves to the previous level in the OSD screen. Decreases the volume level, when not in the OSD menu

#	Feature	Function
15	▲ Button	Moves up one step (in the same level) in the OSD screen, or moves to the previous slide when running a slideshow (see Section 7.7.1)
16	▶ Button	Increases the range by one step in the OSD screen Increases the volume level, when not in the OSD menu
17	▼ Button	Moves down one step (in the same level) in the OSD screen, or moves to the next slide when running a slideshow (see Section 7.7.1)
18	RESET TO XGA/720p Button	Press and hold to reset to the default resolution (toggles between RESET TO XGA and 720p)
19	PANEL LOCK Button	Press to lock/unlock the front panel to prevent unintentional operation
20	USB Connector	Connects to a USB drive to read JPEG files (smaller than 1MB and up to a resolution of 2048x1536) and also to download new firmware

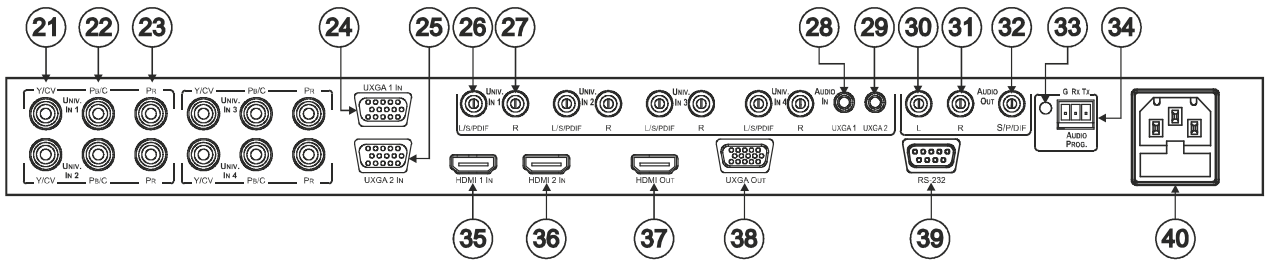

Figure 2: VP-728 Presentation Switcher/Scaler Rear Panel

#	Feature	Function
21	UNIV. IN RCA Connectors (from 1 to 4)	Y/CV
22		Pb/C
23		Pr
24	UXGA 1 IN 15-pin HD Connector	Connects to the UXGA (analog interface) graphics source 1
25	UXGA 2 IN 15-pin HD Connector	Connects to the UXGA (analog interface) graphics source 2
26	AUDIO IN UNIV. IN RCA Connectors (from 1 to 4)	L/S/PDIF
27		R
28	AUDIO IN 3.5 Mini Jack	UXGA 1
29		UXGA 2
30	AUDIO OUT RCA Connectors	L
31		R
32		S/PDIF
33	AUDIO PROG	Program Button
34		Terminal Block Connector
35	HDMI 1 IN Connector	Connects to the HDMI 1 source
36	HDMI 2 IN Connector	Connects to the HDMI 2 source
37	HDMI OUT Connector	Connects to the HDMI acceptor
38	UXGA OUT 15-pin HD Connector	Connects to the video acceptor that displays the scaled output. In the default HDTV mode, the signal is transmitted via 3 pins: PIN 1 is Pr, PIN 2 is Y, PIN 3 Pb
39	RS-232 9-pin D-sub Connector	Connects to a PC or serial controller
40	Power Connector with Fuse	AC connector for connecting power to the unit

4 Installing in a Rack

This section provides instructions for rack mounting the unit.

Before installing in a rack, be sure that the environment is within the recommended range:

OPERATING TEMPERATURE:	0° to +55°C (32° to 131°F)
STORAGE TEMPERATURE:	-45° to +72°C (-49° to 162°F)
HUMIDITY:	10% to 90%, RHL non-condensing



CAUTION!

When installing on a 19" rack, avoid hazards by taking care that:

1. It is located within the recommended environmental conditions, as the operating ambient temperature of a closed or multi unit rack assembly may exceed the room ambient temperature.
2. Once rack mounted, enough air will still flow around the machine.
3. The machine is placed straight in the correct horizontal position.
4. You do not overload the circuit(s). When connecting the machine to the supply circuit, overloading the circuits might have a detrimental effect on overcurrent protection and supply wiring. Refer to the appropriate nameplate ratings for information. For example, for fuse replacement, see the value printed on the product label.
5. The machine is earthed (grounded) in a reliable way and is connected only to an electricity socket with grounding. Pay particular attention to situations where electricity is supplied indirectly (when the power cord is not plugged directly into the socket in the wall), for example, when using an extension cable or a power strip, and that you use only the power cord that is supplied with the machine.

To rack-mount a machine:

1. Attach both ear brackets to the machine. To do so, remove the screws from each side of the machine (3 on each side), and replace those screws through the ear brackets.

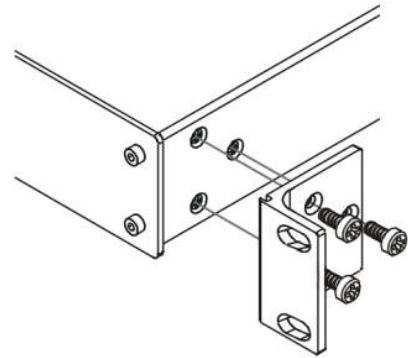

2. Place the ears of the machine against the rack rails, and insert the proper screws (not provided) through each of the four holes in the rack ears.

Note:

- In some models, the front panel may feature built-in rack ears
- Detachable rack ears can be removed for desktop use
- Always mount the machine in the rack before you attach any cables or connect the machine to the power
- If you are using a Kramer rack adapter kit (for a machine that is not 19"), see the Rack Adapters user manual for installation instructions available from our Web site

5 Connecting the VP-728



Always switch off the power to each device before connecting it to your **VP-728**. After connecting your **VP-728**, connect its power and then switch on the power to each device.

To connect the **VP-728** as illustrated in the example in [Figure 3](#), do the following:

1. Connect the video sources:
 - A component video source (for example, a DVD player) to the UNIV. IN 1 RCA connectors, Y/CV, PB/C and PR
Component video is sometimes called YUV, or Y, B-Y, R-Y
 - An s-Video source (for example, a DVD player) to the UNIV. IN 4 RCA connectors, Y/CV and PB/C
 - A computer graphics source to the UXGA 1 IN 15-pin HD computer graphics video connector
 - An HDMI source (for example, a DVD player) to the HDMI 1 IN connector
 - A graphics data source (for example, JPEG files that should be smaller than 1MB and should not exceed a resolution of 2048x1536, from a PC or a USB flash drive) to the USB connector on the front panel of the machine

2. Connect the unbalanced stereo or digital audio sources:
 - The audio of the component video source 1 to the AUDIO UNIV IN 1 S/PDIF RCA connector
 - The audio of the s-Video source 4 to the AUDIO UNIV IN 4 L and R RCA connector
 - The audio of computer graphics source to the AUDIO UXGA 1 3.5mm mini jack

Although this connecting example shows only several inputs that are connected, you can connect all the inputs simultaneously

3. Connect the video outputs:
 - The HDMI OUT connector to an HDMI acceptor (for example, a plasma display)
 - The UXGA OUT 15-pin HD computer graphics video connector to a video acceptor (for example, an analog display)
In the HDTV mode, the signal goes out via three PINS: PIN 1 is Red or Pr, PIN 2 is Green or Y, PIN 3 is Blue or Pb
4. Connect the AUDIO OUT L and R unbalanced stereo audio output and/or the S/PDIF digital audio output to audio acceptors, for example, power amplifiers.
5. Connect the power cord.
We recommend that you use only the power cord that is supplied with this machine
6. If required, connect a PC via RS-232, (see [Page 13](#)).



The USB connector, audio sources and acceptors, and power cord are not shown in [Figure 3](#).

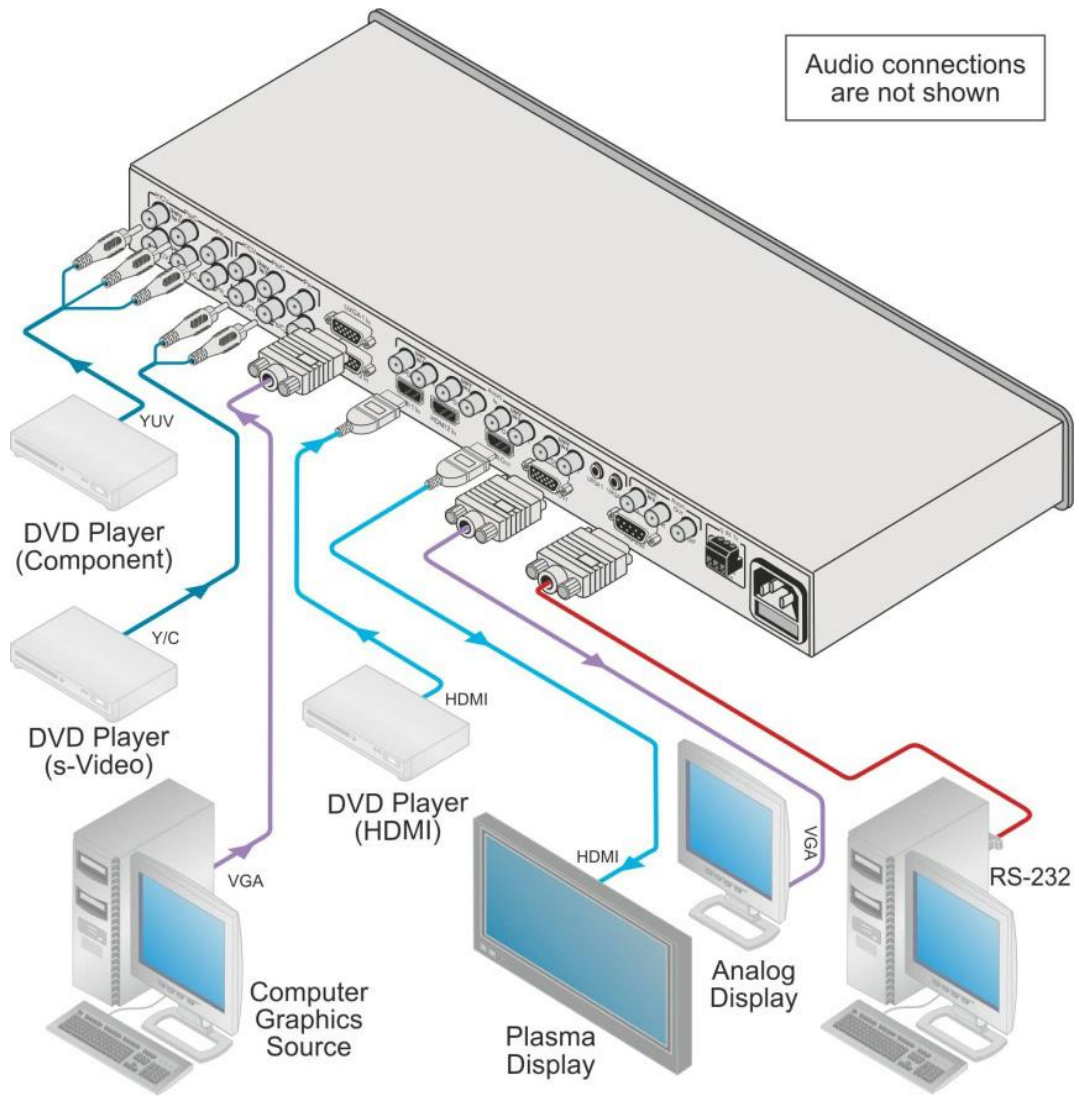

Figure 3: Connecting to the VP-728 Rear Panel

5.1 Connecting a PC

You can connect to the unit via a crossed RS-232 connection, using for example, a PC. A crossed cable or null-modem is required as shown in method A and B respectively. If a shielded cable is used, connect the shield to pin 5.

Method A ([Figure 4](#))—Connect the RS-232 9-pin D-sub port on the unit via a crossed cable (only pin 2 to pin 3, pin 3 to pin 2, and pin 5 to pin 5 need be connected) to the RS-232 9-pin D-sub port on the PC.

Note: There is no need to connect any other pins.

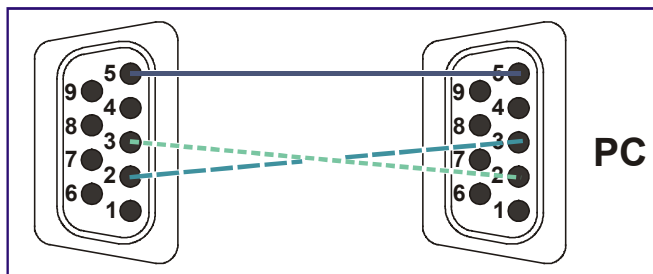

Figure 4: Crossed Cable RS-232 Connection

Hardware flow control is not required for this unit. In the rare case where a controller requires hardware flow control, short pin 1 to 7 and 8, and pin 4 to 6 on the controller side.

Method B ([Figure 5](#))—Connect the RS-232 9-pin D-sub port on the unit via a straight (flat) cable to the null-modem adapter, and connect the null-modem adapter to the RS-232 9-pin D-sub port on the PC. The straight cable usually contains all nine wires for a full connection of the D-sub connector. Because the null-modem adapter (which already includes the flow control jumpering described in Method A above) only requires pins 2, 3 and 5 to be connected, you are free to decide whether to connect only these 3 pins or all 9 pins.

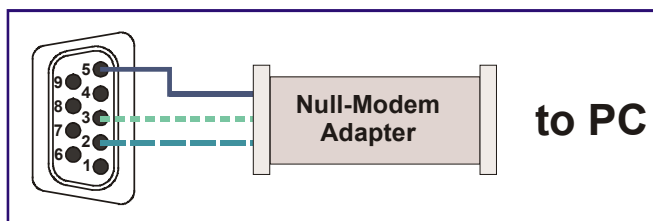

Figure 5: Straight Cable RS-232 Connection with a Null Modem Adapter

6 Presentation Switcher / Scaler Buttons

The **VP-728** includes the following front panel buttons:

- Nine INPUT selector buttons
- A PIP button
- BLANK and FREEZE buttons
- Six OSD buttons
- A RESET TO XGA/720p button
- A PANEL LOCK button

6.1 Switching an Input

Each INPUT SELECTOR button can be used to select the source. When selected, the button illuminates.

You can switch seamlessly between each input that is connected to a source by pressing the appropriate INPUT SELECTOR button.

SEAMLESS SWITCHING - FTB™ switching for glitchless transitions between inputs

6.2 The PIP Button Feature

The Picture-in-Picture inserter (PIP) uses K-IIT XL™ image insertion technology to present video and graphic sources simultaneously so that you can display:

- An inserted video source PIP over a graphic source background
- An inserted graphic source PIP over a video source background

VIDEO SOURCE – can be composite or s-Video

GRAPHIC SOURCE – can be HDMI, UXGA or component

For example, you can show a live video window on top of a graphic background and vice versa.

If the HDMI signal is HDCP protected, it cannot appear on a display that is not HDCP compliant and the machine will not output a picture on the VGA output

The **VP-728** supports three PIP modes:

- Picture-in-Picture, with a smaller window superimposed over a full screen image
- Picture + Picture, where both images are placed side-by-side with the same height
- Split, where both images appear side-by-side and the aspect ratios of both images are maintained

6.2.1 Activating the PIP Feature

Activate the PIP feature in any of the following ways:

- Press and hold the PIP front panel button while pressing the input button of the required PIP source
- Press the PIP key on the IR remote control transmitter (see [Section 6.4](#))
- Access the OSD PIP menu (see [Figure 13](#)) and selecting PIP On

6.2.2 Selecting the PIP Source

To easily select the PIP source, press and hold the PIP front panel button while pressing the input button of the required PIP source.

For example, to select UXGA 2 as the graphic PIP source over a video background, press the PIP front panel button while pressing the UXGA 2 front panel button.

To select the PIP source using the IR remote controller, press the desired PIP source on the remote controller.

For example, if you want to select HDMI 2 as the PIP source, press the HDMI 2 button in the PIP source area on the IR remote controller.

To set the PIP source via the OSD menu, do the following:

1. Press the MENU button to enter the OSD menu.
2. Press the ► button to move to the PIP icon.
3. Scroll down to select Source and press ENTER.
4. Use the ▲ or ▼ buttons to select the PIP Source from the drop-down list box, and press ENTER (see [Figure 13](#)).
5. To exit the OSD menu, press the MENU button.



Figure 6: PIP Source over Background

To replace a PIP source in the same category (for example, changing the PIP source from HDMI 2 to HDMI 1), press the required PIP Source on the remote control transmitter and the PIP display will change accordingly.



When attempting to select a PIP source of the same category as the background source (for example, video on video, which is not compliant with the table on [Page 18](#)), a message is displayed, “Unavailable Operation”.

6.2.3 Toggling between the PIP and the Screen Source (Swap)

To toggle back and forth between the PIP source and the main display, as [Figure 7](#) illustrates, press the Swap key on the infrared remote control transmitter (see [Figure 8](#)). You can also do this via the OSD menu by selecting a new Input Source through the Input menu and a new PIP source through the PIP menu.



Figure 7: The SWAP Status

When selecting one PIP source, the **VP-728** automatically recognizes and displays the selected graphic PIP source on all the video displays and the selected video source on all the graphic displays, compliant with the table on [Page 18](#).

The PIP source appears even if the input signal is not connected. In this case the PIP appears over a blank screen

To replace a PIP in the same input signal category (for example, changing from UXGA 1 to HDMI 2), press the button for that PIP Source on the remote control transmitter and the PIP display will change accordingly.

Main Source		PIP Source Appearance Availability																			
		PIP Source															VGA 1	VGA 2	HDMI 1	HDMI 2	USB
		Input 1			Input 2			Input 3			Input 4										
Video	YC	Comp	Video	YC	Comp	Video	YC	Comp	Video	YC	Comp	VGA 1	VGA 2	HDMI 1	HDMI 2	USB					
Input 1	Video	x	x	x	x	x	✓	x	x	✓	x	x	✓	✓	✓	✓	✓	x			
	YC	x	x	x	x	x	✓	x	x	✓	x	x	✓	✓	✓	✓	✓	x			
	Comp	x	x	x	✓	✓	x	✓	✓	x	✓	✓	x	x	x	x	x	x			
Input 2	Video	x	x	✓	x	x	x	x	x	✓	x	x	✓	✓	✓	✓	✓	x			
	YC	x	x	✓	x	x	x	x	x	✓	x	x	✓	✓	✓	✓	✓	x			
	Comp	✓	✓	x	x	x	x	✓	✓	x	✓	✓	x	x	x	x	x	x			
Input 3	Video	x	x	✓	x	x	✓	x	x	x	x	x	✓	✓	✓	✓	✓	x			
	YC	x	x	✓	x	x	✓	x	x	x	x	x	✓	✓	✓	✓	✓	x			
	Comp	✓	✓	x	✓	✓	x	x	x	x	✓	✓	x	x	x	x	x	x			
Input 4	Video	x	x	✓	x	x	✓	x	x	✓	x	x	x	✓	✓	✓	✓	x			
	YC	x	x	✓	x	x	✓	x	x	✓	x	x	x	✓	✓	✓	✓	x			
	Comp	✓	✓	x	✓	✓	x	✓	✓	x	x	x	x	x	x	x	x	x			
VGA 1		✓	✓	x	✓	✓	x	✓	✓	x	✓	✓	x	x	x	x	x	x			
VGA 2		✓	✓	x	✓	✓	x	✓	✓	x	✓	✓	x	x	x	x	x	x			
HDMI 1		✓	✓	x	✓	✓	x	✓	✓	x	✓	✓	x	x	x	x	x	x			
HDMI 2		✓	✓	x	✓	✓	x	✓	✓	x	✓	✓	x	x	x	x	x	x			
USB*		✓	✓	x	✓	✓	x	✓	✓	x	✓	✓	x	x	x	x	x	x			

means Yes; means No

*For a USB source with the PIP enabled, the output image size is limited to 960 horizontal pixels

6.3 Locking and Unlocking the Front Panel

To prevent changing the settings accidentally or tampering with the unit via the front panel buttons, lock your **VP-728**.

Unlocking releases the protection mechanism.

When the front panel is locked, control is still available via RS-232.

To lock the **VP-728**:

- Press the PANEL LOCK button on the front panel.
The front panel is locked and the PANEL LOCK button is illuminated.
Pressing any button other than the PANEL LOCK button has no effect

To unlock the **VP-728**:

- Press the illuminated PANEL LOCK button on the front panel
The front panel unlocks and the PANEL LOCK button is no longer illuminated

The Save Lock and Input Lock OSD functions are defined in the table on [Page 34](#).

6.4 The Infrared Remote Control Transmitter

You can control the **VP-728** remotely from the infrared remote control transmitter which is powered by two AAA size 1.5V DC batteries. The IR remote control transmitter:

- Has a range of up to 15 meters
- Delivers instantaneous results

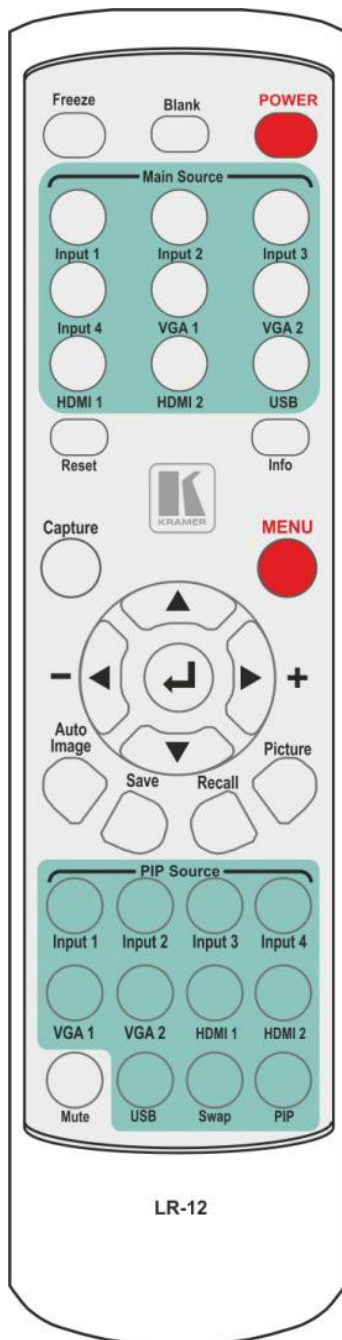

Figure 8: IR Remote Control Transmitter

Key	Function
Freeze	Pauses the output video and can be programmed to mute the audio signal at the same time (see Page 34)
Blank	Toggles between a blank screen (blue or black) and the display
POWER	Cycles power
Main Source	9 keys for selecting one of the following sources: Input 1, Input 2, Input 3, Input 4, VGA 1, VGA2, HDMI 1, HDMI 2, and USB
Reset	Press and hold to reset to the default resolution (toggles between RESET TO XGA and 720p)
Info	Press to toggle the Info OSD menu
Capture	Captures an image to place as a logo or background (see Page 33)
MENU	Shows the main OSD Menu
Navigation arrows	Allows maneuvering within an OSD screen (left, right, up and down, as well as the ENTER arrow at the center). The + and - buttons increase and decrease the volume level, respectively (when not in the OSD menu)
Auto Image	Press to assess the image and improve the quality accordingly, by automatically adjusting the phase, frequency and position
Save	Press to save a profile
Recall	Press to recall a profile
Picture	Press to display the Picture OSD menu
PIP source	9 keys for selecting one of the following PIP sources: Input 1, Input 2, Input 3, Input 4, VGA 1, VGA2, HDMI 1 and HDMI 2
Mute	Press to mute the audio signal
Swap	Press to toggle between the PIP content and the parent screen content
PIP	Press to select the picture-in-picture (the PIP button illuminates) see Page 15

7 Configuring the VP-728 via the OSD MENU Screens

The **VP-728** uses an on-screen display (OSD) menu for system configuration. The menu appears as an overlay over any images that are output from the **VP-728**.

There are eight sub-menus that are used to configure the **VP-728**. You can activate and navigate these menus from the front panel buttons, or from the IR remote control.



Figure 9: MENU Items

To access and use the OSD menus, push the button for the desired input signal, then press the MENU front panel OSD button or the MENU key on the infrared remote control transmitter to display the main MENU screen which shows the eight interactive icons.

- Press the ◀ or ▶ buttons to select the desired sub-menu, and then press ENTER
- Press the ▲ or ▼ buttons to select the menu item to be adjusted, and then press ENTER
- Press the ▲ or ▼ buttons to make the adjustment and then press ENTER, or
- Press the ◀ or ▶ buttons to increase or decrease the (numerical) value as needed

To return to the previous menu level, press the front panel MENU button or the MENU key on the remote control. All settings and adjustments are automatically saved in non-volatile memory for each of the inputs (except USB).



The values defined in the different menus may change according to the firmware version (you can download the up-to-date firmware version from our Web site at <http://www.kramerelectronics.com>).

7.1 The Input Screen



Figure 10: Input Screen

Setting	Function	Default
Source	Select the source: Input 1, Input 2, Input 3, Input 4, VGA 1, VGA 2, HDMI 1, HDMI 2 or USB When switching sources, the image fades through black The source is automatically updated when pressing an input front panel button on the machine	
Input (1 to 4) Source Type	Select the source type: Component, YC or video (CV)	Video
Image Name	Select the file name of the image displayed when the USB port is selected as an input This feature is available when the slideshow feature is set to Off (see Section 7.7.1) This feature supports JPEG format only. The JPEG file should be smaller than 1MB and should not exceed a resolution of 2048x1536. If the image file is not within the definition, the machine displays the message: "Size Too Big"	
Color Format	Select the color format: Auto, RGB or YUV	Auto
Video Standard	Select the video standard: Auto, NTSC, PAL, PAL-M, PAL-N, NTSC 4.43, SECAM or PAL-60	Auto
H-Position	Set the horizontal position according to the input resolution For UXGA and component video inputs	
V-Position	Set the vertical position according to the input resolution	
Frequency	Adjust the frequency: 0 to 50 For UXGA inputs	0
Phase	Adjust the phase: 0 to 31	0
Auto image	Assesses the image and improves the quality accordingly, by automatically adjusting the phase, frequency and position	

7.1.1 Reading JPEG Files

You can read the JPEG files via the USB input. The JPEG files can be used to display a JPEG image, download a new Logo or background (see [Page 33](#)) or create a slideshow (see [Section 7.7.1](#)).

To read JPEG files:

1. Load the JPEG images (the JPEG file should be smaller than 1MB and should not exceed a resolution of 2048x1536) to the root directory of a USB memory stick.
2. Connect the Memory stick to the USB connector on the front panel.
3. Select the USB INPUT button on the front panel.
4. Select the desired image.

7.2 The Picture Screen

The Brightness, Contrast, Color and Hue picture settings are saved individually for each input (except USB).

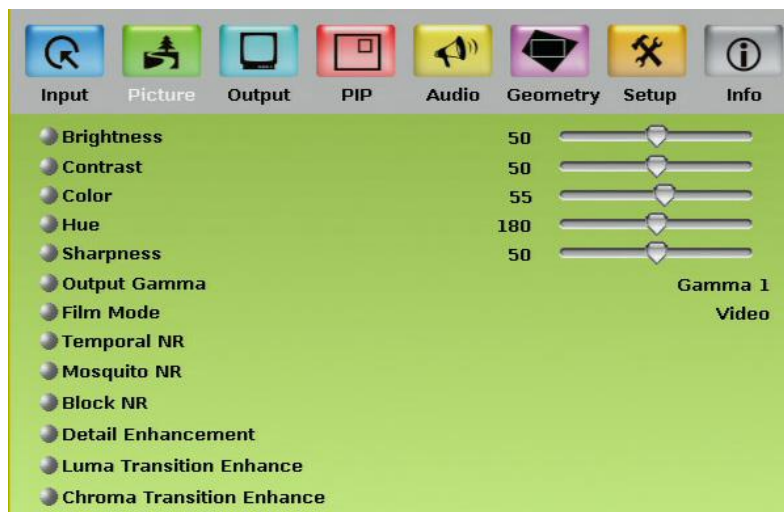

Figure 11: Picture Screen

Setting	Function	Default
Brightness	Adjust the brightness: 0 to 100	50
Contrast	Adjust the contrast: 0 to 100	50
Color	Adjust the color: 0 to 100	55
Hue	Adjust the hue: 0 to 360	180
Sharpness	Adjust the sharpness: 0 to 100	50
Output Gamma	Adjust the gamma: Gamma 1 to Gamma 5	Gamma 1
Film Mode	Set the film mode: Auto, Video, Film	Auto
Temporal NR	Set the temporal noise reduction level: Off, Low, Medium, High	High
Mosquito NR	Set the Mosquito noise reduction level: Off, Low, Medium, High	Low
Block NR	Set the block noise reduction level: Off, On	Off
Detail Enhancement	Set the detail enhancement: Off, Low, Medium, High If the USB input is selected, Detail Enhancement is set to Off	Medium
Luma Transition Enhance	Set the luminance transition enhance level: Off, Low, High	Low
Chroma Transition Enhance	Set the chrominance transition enhance level: Off, Low, High	Low

7.3 The Output Screen



Figure 12: Output Screen

Setting	Function	Default
Resolution	<p>Set the resolution: Native HDMI, 640x480x60Hz, 640x480x75Hz, 800x600x50Hz, 800x600x60Hz, 800x600x75Hz, 1024x768x50Hz, 1024x768x60Hz, 1024x768x75Hz, 1280x768x50Hz, 1280x768x60Hz, 1280x720x60Hz, 1280x800x60Hz, 1280x1024x50Hz, 1280x1024x60Hz, 1280x1024x75Hz, 1366x768x50Hz, 1366x768x60Hz, 1400x1050x50Hz, 1400x1050x60Hz, 1600x1200x50Hz, 1600x1200x60Hz, 1680x1050x60Hz, 1920x1080x60Hz, 1920x1200x60Hz, 480px60Hz, 576px60Hz, 720px50Hz, 720px60Hz, 1080ix50Hz, 1080ix60Hz, 1080px50Hz, 1080px60Hz, 720x480x59.94Hz, 1280x720x59.94Hz, 1920x1080ix59.94Hz, 1920x1080x23.98Hz, 1920x1080x29.97Hz, 1920x1080x59.94Hz or Custom (from 1 to 4)</p> <p>Note that any change in the resolution must be confirmed via the count-down message that appears on the screen</p> <p>The embedded audio feature is not available for the RGB resolutions 1920x1200 and 1920x1080. (It is available for 1080p)</p>	1024x768@60Hz
HDMI Type	Set the HDMI type: Auto, HDMI, DVI	Auto
Aspect Ratio	<p>Set the aspect ratio (also see Section 7.3.1):</p> <p>Best Fit - the best possible compromise between the input and the output aspect ratios</p> <p>Letterbox</p> <p>Follow Output - If the input ≤ output, scale up the picture. If the input ≥ output, scale down the picture</p> <p>Virtual Wide</p> <p>Follow Input - If the input ≤ output, display with a blank border. If the input ≥ output, crop the image</p> <p>Custom</p>	Follow Output
H-Pan	<p>Horizontal pan: -16 to 16</p> <p>This feature is available when selecting Custom aspect ratio</p>	0
V-Pan	<p>Vertical pan: -16 to 16</p> <p>This feature is available when selecting Custom aspect ratio</p>	0
H-Zoom	<p>Horizontal zoom: -8 to 8</p> <p>This feature is available when selecting Custom aspect ratio</p>	0
V-Zoom	<p>Vertical zoom: -8 to 8</p> <p>This feature is available when selecting Custom aspect ratio</p>	0

Setting	Function	Default
Zoom	Set the Zoom: 100%, 150%, 200%, 225%, 250%, 275%, 300%, 325%, 350%, 375%, 400% or Custom	100%
Custom Zoom	Set the Zoom: From 100% to 400%	
Zoom H-Pan	0 to 31	16
Zoom V-Pan	0 to 31	16

7.3.1 Selecting the Correct Aspect Ratio

You can configure the aspect ratio of any output image to fit your application. The **VP-728** offers six different aspect ratio settings: Best Fit, Letterbox, Follow Output, Virtual Wide, Follow Input, and Custom. Here is how each of these settings works.

BEST FIT – This setting re-sizes the video or graphics input signal to “best fit” the output resolution while maintaining the aspect ratio of the input signal. For example, a composite video signal (4:3 aspect ratio) will “best fit” to the top and bottom of a widescreen output image, resulting in black pillars on either side.



LETTERBOX – This setting compresses the top and bottom edges of the input signal, but fills the width of the screen.



FOLLOW OUTPUT – The aspect ratio and resolution of the input signal is re-sized to precisely match the aspect ratio and resolution of the VP-728 output signal. This may result in some distortion to the input signal images

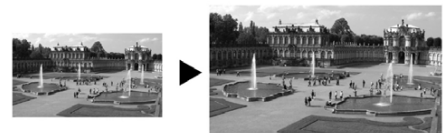

VIRTUAL WIDE – The input signal is stretched horizontally to fit the width of a widescreen output image from the VP-728. This setting is used to expand anamorphic (horizontally compressed) video images from DVDs



FOLLOW INPUT – The aspect ratio and resolution of the input video or graphics signal are both preserved. For example, a composite video image with a 4:3 aspect ratio will appear with the same aspect ratio on a 1080p (16:9) output image, surrounded by black bars

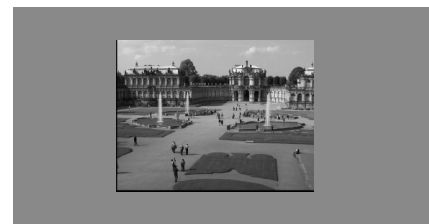

CUSTOM – Use this menu to define a custom aspect ratio by adjusting the output image horizontal size (width) and vertical size (height)



7.4 The PIP Screen



Figure 13: PIP Screen

Setting	Function	Default
On/Off	Activate/deactivate the PIP feature: On/Off For a USB source with the PIP enabled, the maximum output image size is 960 horizontal pixels	Off
Type	Select the PIP type: Picture-In-Picture, Picture + Picture or Split (see Section 6.2)	Picture-In-Picture
Source	Select the PIP source (see table in Page 18) When changing the PIP source, the display fades through black	
PIP Size	Select the PIP size: 1/25, 1/16, 1/9, 1/4, or Custom The PIP size can be set up to the full height and up to half the width of the screen	1/4
H-Position	Set the horizontal position of the PIP on the display: 0 – 128	3
V-Position	Set the vertical position of the PIP on the display: 0 – 128	0
H-Size	Set custom size: 1 – 256 The actual range depends upon the input resolution	
V-Size	Set custom size: 1 – 256 The actual range depends upon the input resolution	
Frame	Turn the PIP frame on or off: On/Off	On
Frame Color	Select the color of the PIP frame: Red, Green or Blue	Blue

7.5 The Audio Screen

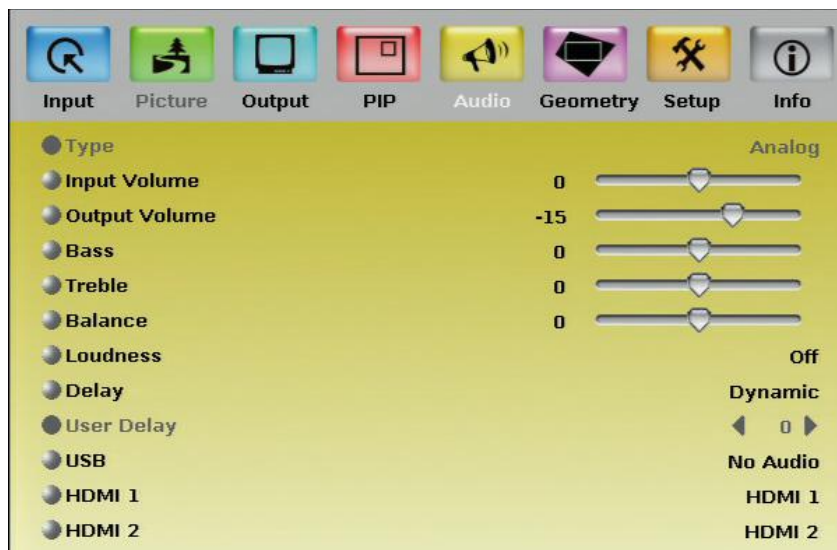

Figure 14: Audio Screen

Setting	Function	Default
Type	Select the audio input type (available for IN 1 to IN 2): Analog or S/PDIF	Analog
Input Volume	Adjust the input volume: -22 to 22	0
Output Volume	Adjust the output volume: -100 to 24	0
Bass	Adjust the bass: -36 to 36	0
Treble	Adjust the treble: -36 to 36	0
Balance	Adjust the balance: -10 to 10	0
Loudness	Set the loudness: On/Off	Off
Delay	Define the delay type: Dynamic or User Define Select Dynamic for the audio delay to equal the pipeline video delay or User Define to set the delay time manually (via User Delay)	Dynamic
User Delay	Available when selecting the User Defined delay: 0 to 340 (msec) Set the delay in 2msec steps	0
USB	Select the audio signal to follow the USB signal: No Audio, Input 1, Input 2, Input 3, Input 4, VGA 1, VGA 2, HDMI 1 or HDMI 2	No Audio
HDMI 1/HDMI 2	Select the audio source to be embedded	HDMI

7.6 The Geometry Screen



Figure 15: Geometry Screen

Setting	Function	Default
Application	Select the output application: Keystone, Anyplace or Rotation	Keystone
Location	Select the location of the display: Front, Rear, Ceiling or Rear ceiling	Front
Horizontal Keystone	Adjust the horizontal keystone: -40 to 40 If the projector is located at an angle to the left or right of the screen	0
Vertical Keystone	Adjust the vertical keystone: -30 to 30 If the projector is located at an angle above or below the screen	0
Diagonal Projection	Move the location of each corner of the display separately: Top Left, Top Right, Bottom Left, Bottom Right or Reset (to reset diagonal projections settings)	Top Left
Pincushion/Barrel	Adjust the pincushion or barrel appearance of the screen: -20 to 20	0
Rotation	Rotate the display by 180 degrees clockwise or counterclockwise: -180 to 180	0
Reset all	Resets the geometry values to their default value	

The settings available for each application are defined in the following table:

Application	Available Settings
Keystone	Location, horizontal keystone, vertical keystone, pincushion/barrel and Reset all
Anyplace	Location, Diagonal Projection and Reset all
Rotation	Location, pincushion/barrel, Rotation and Reset all

7.7 The Setup Screen



Figure 16: Setup Screen

Setting	Function	Default
Save	Saves up to eight profiles from 1 to 8	
Recall	Recalls a profile from 1 to 8	
Slideshow	Set the speed for the slide show to Min, Low, Mid, Long, Max or Off (see Section 7.7.1)	Min
Frame Lock	Locks the vertical refresh rate of the output to that of the input. Set to On or Off. Note that seamless switching is not possible when working in the Frame Lock mode unless all sources are frame synchronized. In cases where the output resolution can support the vertical refresh rate of the input, the output refresh rate will change according to the input refresh rate	Off
Auto Image	Automatically adjusts and aligns the picture each time one of the UXGA inputs is selected or if the UXGA input resolution has changed. Set to Manual or Auto	Manual
Switching Mode	Selects seamless switching (fade-through-Black) or Fast switching which is faster but may cause glitches on the output (applies when switching between analog inputs)	Seamless
Factory Reset	Select Yes to reset your VP-728 to its preset default settings	
Advanced Setup	Opens the advanced setup menu screen (see Figure 17), which includes the: Mode Set, OSD, Misc, Input and Output OSD menus (Section 7.8)	
HDMI Switch Behavior	Set to DVD/Normal or PC/Bypass Set to Normal for sources with HDCP. When in Normal operation, the unit sends a hot plug to the source for any Group/Scaler switching request. There might be some graphic cards that might shut OFF the VGA/HDMI output following the hot plug detection. To prevent this, set this parameter to the Bypass mode so the unit will not send a hot plug for switching request (the hot plug will be detected by the source only when plugging a physical connection)	Normal
HDMI Input HDCP	Set to On or Off for each HDMI input HDCP support can be enabled (On) or disabled (Off) for each of the HDMI inputs, allowing the source to transmit a non-HDCP signal if required (for example, when working with a Mac computer)	

7.7.1 The Slideshow Feature

The **VP-728** lets you run a slideshow via the USB input and set the slideshow speed via the slideshow feature.

To prepare a slideshow:

1. Load the slideshow JPEG images to a USB memory stick.
The slides will appear in alphabetical order.
The JPEG file should be smaller than 1MB and should not exceed a resolution of 2048x1536
2. Open the Setup menu and set the desired speed in the slideshow item and then close the menu.
3. Connect the Memory stick to the USB connector on the front panel.
4. Select the USB INPUT button on the front panel.
The slideshow begins at the set speed.
You have to set the slideshow parameters before you run the slideshow

You can control the slide show by pressing the:

- FREEZE button to pause
- USB button to play and stop the slideshow
- ▲ (up arrow) button to go to the previous slide
- ▼ (down arrow) button to go to the next slide

7.8 The Advanced Setup Screen



Figure 17: Advanced Setup Screen

The Mode Set functions define the desired working resolution and refresh rate when the system cannot distinguish between similar resolutions (for example, resolutions that have the same number of lines can be defined to identify refresh rate values).

Setting	Function	Selection/Range	Default
Mode 1	Set mode 1	1400x1050x60Hz 1680x1050x60Hz	1400x1050x60Hz
Mode 2	Set mode 2	1280x1024x75Hz 1280x1024x76Hz	1280x1024x75Hz
Mode 3	Set mode 3	1280x768x60Hz 1366x768x60Hz	1280x768x60Hz

If two resolutions have the same number of lines (for example, 1050), we can define them so that the unit identifies them as 1400x1050 or as 1680x1050.

7.8.1 The OSD Screen Functions

Setting	Function	Selection/Range	Default
Menu Position	Set the location of the OSD menu	Center, Top Left, Top Right, Bottom Left, Bottom Right	Center
Time Out (sec)	Set the OSD menu timeout	5, 10, 20, 30, 60, 90 or Off	30

7.8.2 The Misc Screen functions

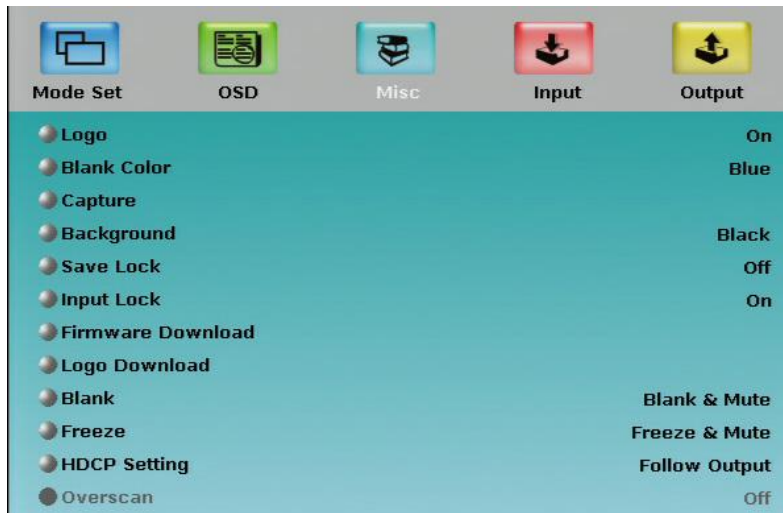



Figure 18: Misc Screen

Setting	Function	Default
Logo	Select On, Off or Custom Choose ON for the start up logo to appear on the screen Choose OFF for it not to appear Set to Custom to download a custom Logo (Flash ROM). The logo can be obtained via the Capture function or downloaded via USB (Logo Download)	Kramer Logo
Blank Color	Select Black or Blue Set the blank color (the color that appears on the screen when the blank button is pressed)	Blue
Capture	Press to capture the currently displayed image. The machine prompts "Capture". This captured image can be used as a logo or as the background if the background setting is set to Custom, or when no input is connected and the output sync is ON.  <ol style="list-style-type: none"> 1. The unit can capture the image for an input source with a resolution up to 1920x1200 If the output resolution is too high, the machine prompts "Output resolution too high for Capture" 2. The output resolution must be <1400 horizontal pixels in order to capture 3. The PIP must be off in order to use the capture feature The machine prompts "Cannot Capture with PIP" if PIP is on	
Background	Select Blue, Black, Custom or Disable Analog Sync to set the background screen color if an input without a signal is selected Selecting Custom will automatically bring up a custom (captured) screen image, that can be obtained via the Capture function or downloaded via USB (Logo Download) Selecting Disable Analog Sync will cause the output SYNC to turn to off if an output is not connected for over 2 minutes for better energy efficiency	Default

Setting	Function	Default
Save Lock	Select On or Off Set to ON to save the lock status when the machine is powered down	Off
Input Lock	Select On or Off Set to OFF so you can still use the SOURCE buttons on the front panel even when the lock button is on	On
Firmware Download	Select and confirm to download the firmware via the USB connection	
Logo Download	Download a new logo via the USB connection Make sure the USB is not selected as the system input when downloading the logo	
Blank	Select Blank & Mute, Blank or Mute to determine the behavior of the BLANK front panel button Set to Blank & Mute to blank the output image and mute the audio Set to Blank to blank the output Set to Mute to mute the audio	Blank & Mute
Freeze	Select Freeze & Mute, Freeze or Mute to determine the behavior of the FREEZE front panel button Set to Freeze & Mute to Freeze the output image and mute the audio Set to Freeze to Freeze the output Set to Mute to mute the audio	Freeze & Mute
HDCP Setting	Select Follow Input or Follow Output to define whether the HDCP will follow the input or the output When Follow Input is selected, the scaler changes its HDCP output setting (for the HDMI output) according to the HDCP of the input. This option is recommended when the HDMI scaler output is connected to a splitter/switcher (in this mode, switching may not be glitch-free) When Follow Output is selected, the scaler matches its HDCP output to the HDCP setting of the HDMI acceptor to which it is connected. This ensures smooth switching, regardless of the input	Follow Output
Overscan	Select On or Off Set to On to Allow stretching of the outputted picture This feature is enabled only for HD input resolutions	Off

7.8.3 The Input Functions Screen



Figure 19: Input Functions

Setting	Function	Default
Custom Input	Custom Input from Custom 1 to custom 4	Custom 1
HT	Horizontal Total	1344
HW	Horizontal sync pulse width	136
HS	Horizontal active start point	296
HA	Horizontal active region	1024
HP	Horizontal polarity	
VT	Vertical Total	806
VW	Vertical sync pulse width	6
VS	Vertical active start point	35
VA	Vertical active region	768
VP	Vertical polarity	
OCLK	Output clock	65
Enable	Set to On to enable parameter change	Off
Save	Apply settings	N/A

7.8.4 The Output Functions Screen

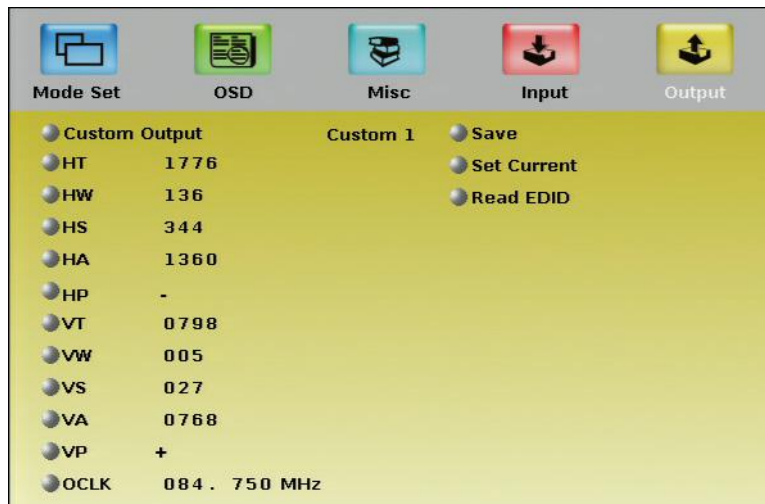

Figure 20: Output Functions

Setting	Function	Default
Custom Output	Custom 1 to Custom 4	
HT	Horizontal total	1344
HW	Horizontal sync pulse width	136
HS	Horizontal active start point	296
HA	Horizontal active region	1024
HP	Horizontal polarity	
VT	Vertical total	806
VW	Vertical sync pulse width	6
VS	Vertical active start point	35
VA	Vertical active region	768
VP	Vertical polarity	
OCLK	Output clock	65
Apply	Press to apply the settings	
Save	Save setup	
Set Current	Import the values of the currently selected output resolution into the User Mode Setting	N/A
Read EDID	Reads the EDID file from the acceptor that is connected to the HDMI output. The EDID is stored as a custom output resolution. This allows automatic handling of LED screens that support very low non-standard resolutions	

[Figure 21](#) illustrates horizontal and vertical sync pulse width, timing and active video area for a typical frame of video.

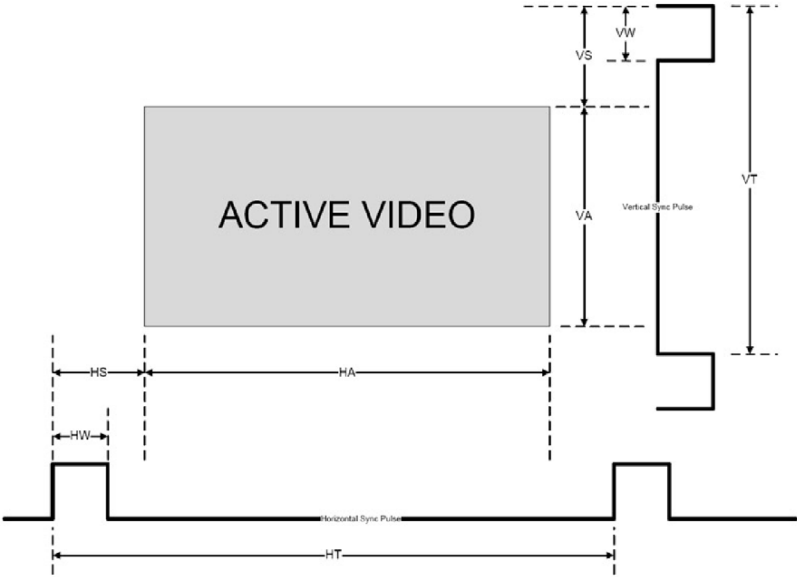

Figure 21: Active Video Functions

7.9 The Info Screen

From the Information screen (see [Figure 22](#)), you can verify the main source, PIP source, the output resolution, the SYNC mode, as well as the firmware revision and the audio board firmware version (for example, 2.9 in [Figure 22](#)):

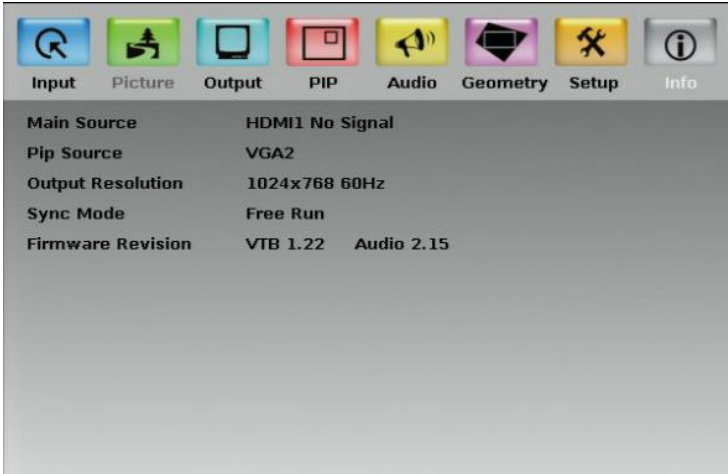

Figure 22: Information Screen



When the output resolution is 1920x1080 or 1920x1200, “No Embedded Audio” will appear in brackets next to the resolution.

8 Using Text Overlay

The text overlay feature is accessed via the Application Program (AP).

Running this AP with the PC connected to the VP-728 lets you display text over the screen, with features including text color and speed, transparency, text position and repetition. Current text overlay settings can be saved and loaded to the AP.

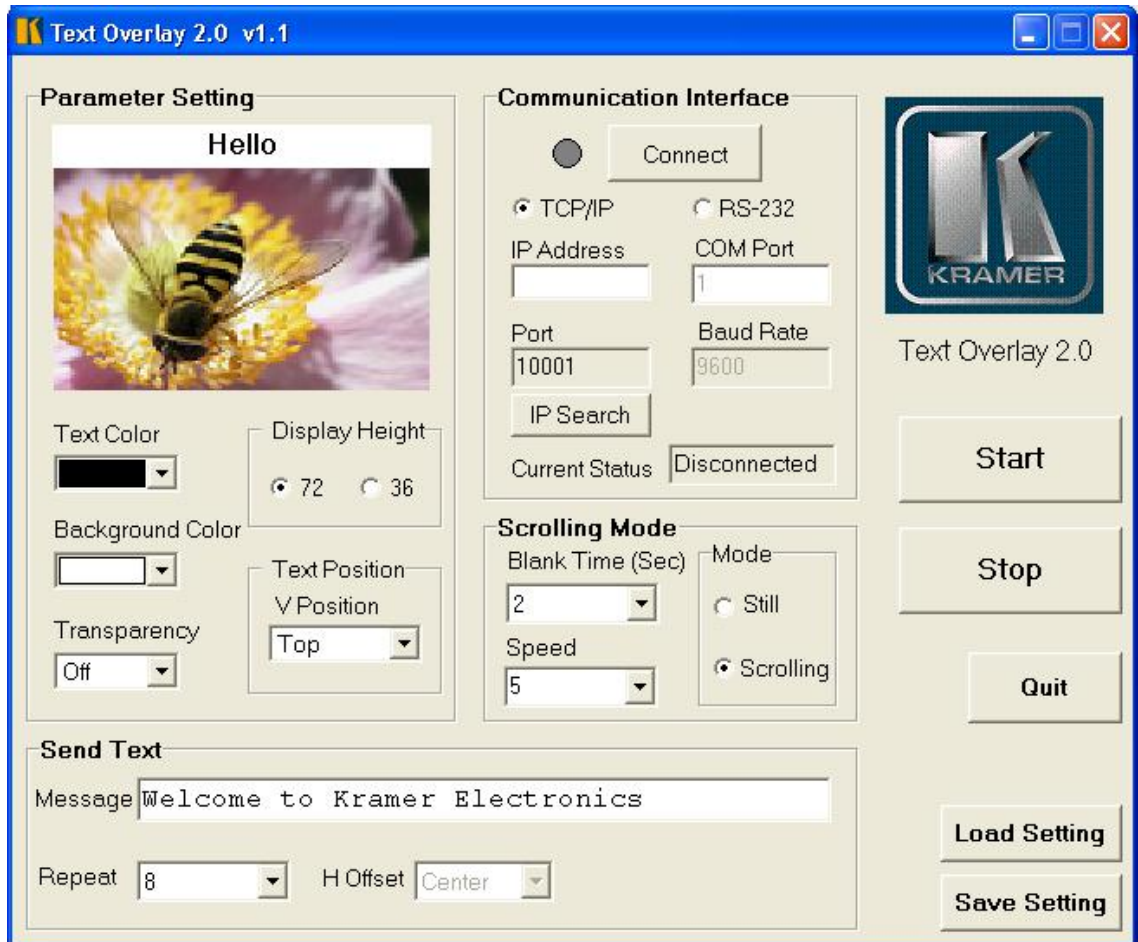

Figure 23: Text Overlay Application Screen

Feature	Function
Parameter Setting Area	
<i>Text Color</i> Dropdown Box	Select the Text color
<i>Background Color</i> Dropdown Box	Set the text background color
<i>Transparency</i> Dropdown Box	Select On for a transparent background or Off for a non-transparent background
Display Height Check Box	Set the thickness of the background stripe (72 or 36)
Text Position – V-Position	Set the vertical position of the text background on the display screen (Top, Center or Bottom)
Communication Interface Area	
Connect/Disconnect	Connect the machine or disconnect
TCP/IP Check box	Not available
RS-232 Check box	When selected, set the <i>COM port</i> and <i>Baud Rate</i> (9600) to connect via the RS-232 connector
Scrolling Mode Area	
Blank Time (Sec) Dropdown Box	Set the blank delay time (from 1 to 5)
<i>Speed</i> Dropdown Box	Set the speed at which the text moves on the display (from 1 to 5)
Mode	Set to <i>Still</i> (fixed text) or <i>Scrolling</i> (text moves across the display)
Send Text Area	
Message	Type the desired text in the <i>Message</i> box
<i>Repeat</i> Dropdown Box	Set the number of times that the text message will scroll across the screen (1 to 20), or set to <i>Forever</i> to repeat the text message continuously For example, set to 2 to repeat the text twice
<i>H-Offset</i> Dropdown Box	After selecting the <i>Static</i> mode, use the <i>H-Offset</i> box to select the horizontal position of the text (Left Center or Right)
Start Button	Click to display the text on screen
Stop Button	Click to stop scrolling on screen
Quit Button	Click to quit the program
Load Setting Button	Click to load a previously saved setting
Save Setting Button	Click to save the current setting

9 Audio Flash Memory Upgrade

The **VP-728** audio firmware is located in FLASH memory, which lets you upgrade to the latest Kramer firmware version in minutes!

Upgrade should be carried out by skilled technical personnel. Failure to upgrade correctly will result in the malfunction of the machine

The process involves:

- Downloading from the Internet
- Connecting the PC to the AUDIO PROG. terminal block connector ([Section 9.2](#))
- Upgrading Firmware

9.1 Downloading from the Internet

You can download the up-to-date file from the Internet. To do so:

1. Go to our Web site at www.kramerelectronics.com and download the file: “*FLIP_VP728.zip*” from the Technical Support section.
2. Extract the file: “*FLIP_VP728.zip*” to a folder (for example, C:\Program Files\Kramer Flash).
3. Create a shortcut on your desktop to the file: “*FLIP.EXE*”.
The files indicated in this section are given as an example only. File names are liable to change from time to time

9.2 Connecting the PC to the RS-232 Port

Before installing the latest Kramer audio firmware version on a VP-728 unit, do the following:

1. Connect the PC to the AUDIO PROG. terminal block connector, as defined below:

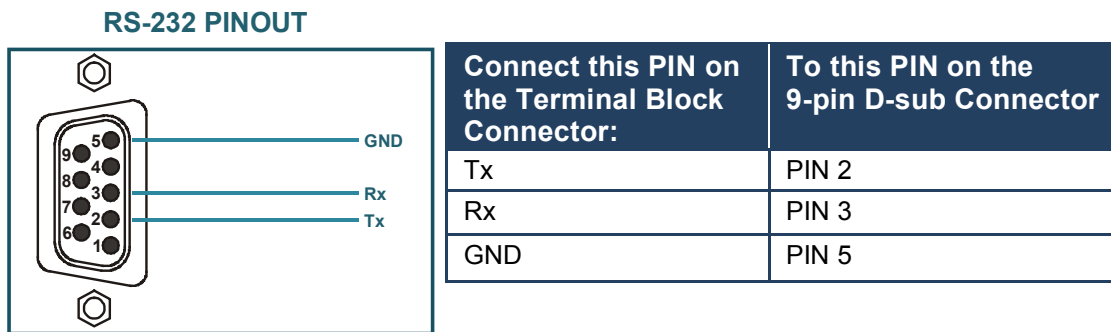

2. Push the AUDIO PROG. button using a small screwdriver.
3. Switch the unit ON.



This sequence is critical – first push the AUDIO PROG button and then turn on the unit.

9.3 Upgrading the Audio Firmware

Follow these steps to upgrade the audio firmware:

1. Double click the desktop icon: “*Shortcut to FLIP.EXE*”.
- The Splash screen appears as follows:

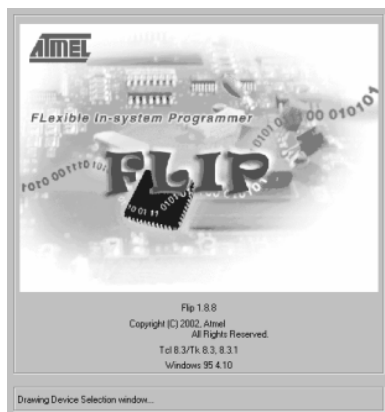

Figure 24: Splash Screen

2. After a few seconds, the Splash screen is replaced by the “Atmel – Flip” window:

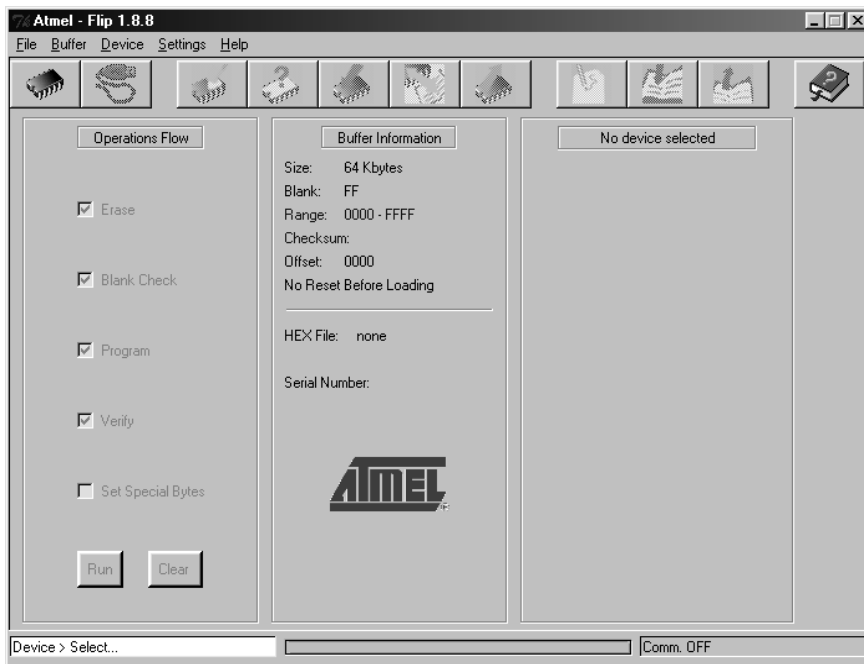

Figure 25: Atmel – Flip Window

3. Press the keyboard shortcut key *F2* (or select the “*Select*” command from the *Device* menu, or press the integrated circuit icon in the upper right corner of the window).

The “*Device Selection*” window appears:



Figure 26: Device Selection Window

4. Click the button next to the name of the device and select from the list:
AT89C51RD2:

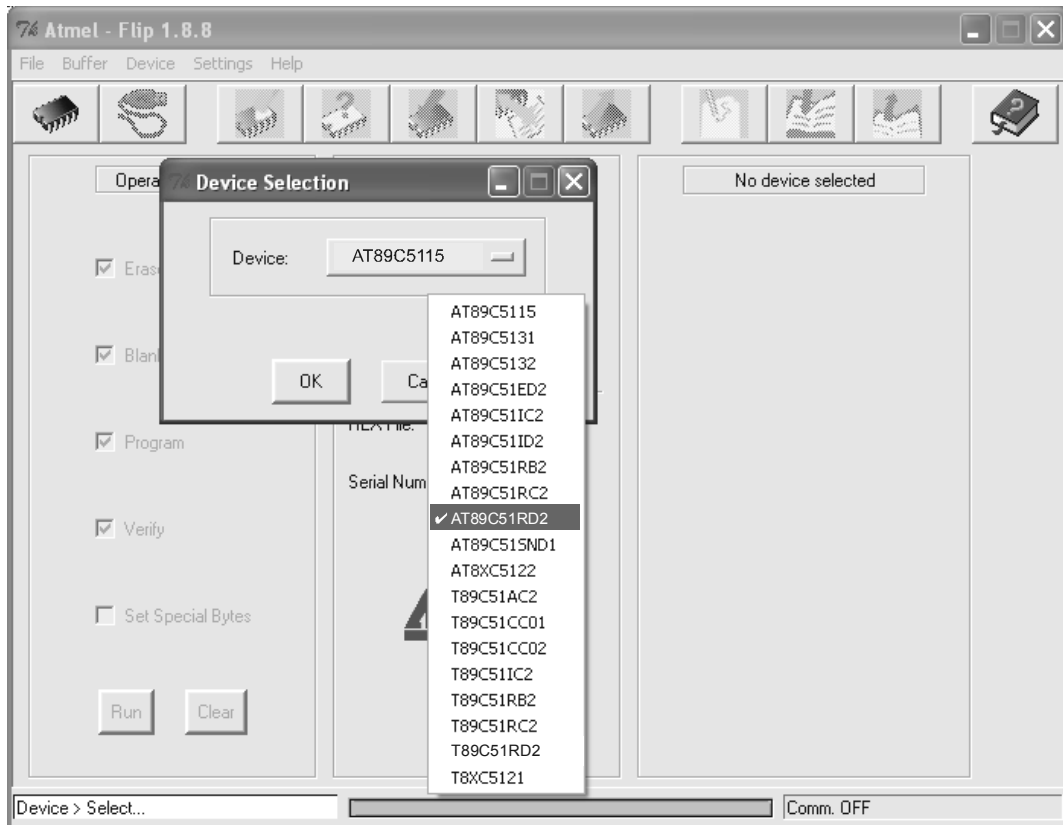

Figure 27: Selecting the Device Window

5. Click OK and select “Load Hex” from the File menu.

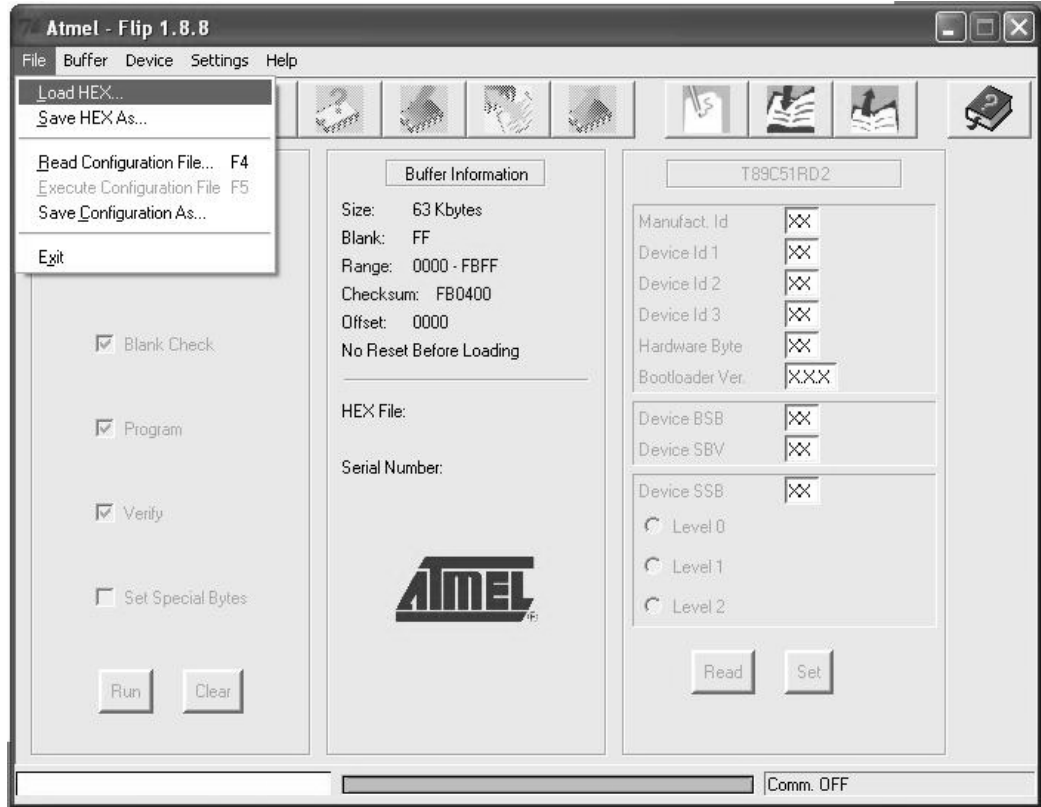

Figure 28: Loading the Hex

6. The Open File window opens. Select the correct HEX file that contains the updated version of the firmware for VP-728 (for example **44M_V1p2.hex**) and click Open.
7. Press the keyboard shortcut key *F3* (or select the “*Communication / RS232*” command from the *Settings* menu, or press the keys: *Alt SCR*).
The “*RS232*” window appears. Change the COM port according to the configuration of your computer and select the 9600 baud rate:

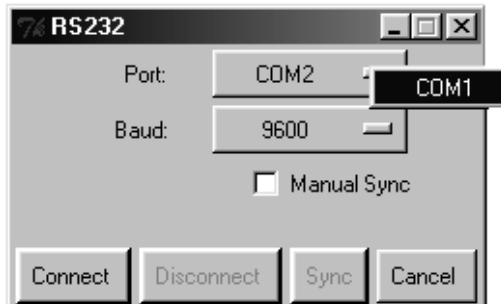

Figure 29: RS-232 Window

8. Click Connect.
In the “*Atmel – Flip*” window, in the *Operations Flow* column, the *Run* button is active, and the name of the chip appears as the name of the third column: **AT89C51RD2**.
Verify that in the *Buffer Information* column, the “*HEX File: VP728.hex*” appears.

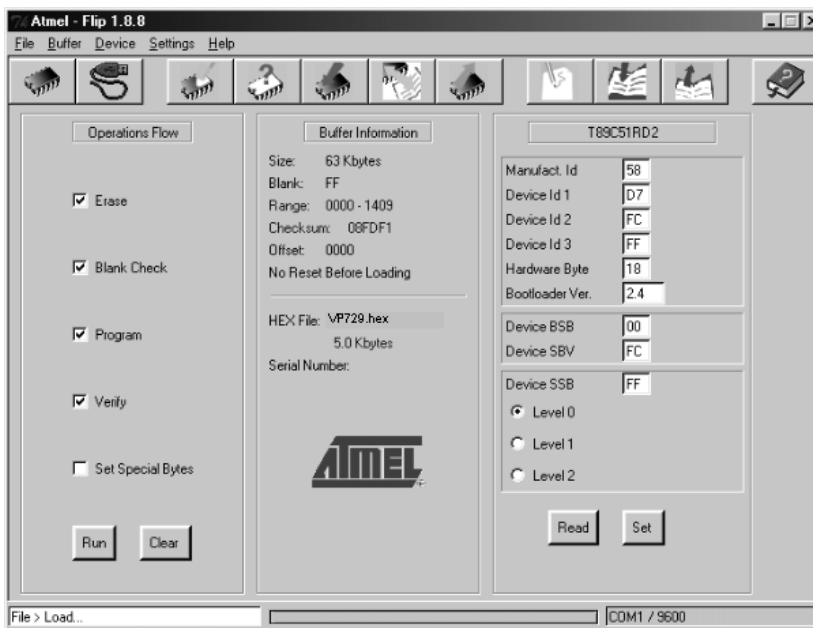

Figure 30: Atmel – Flip Window (Connected)

9. Click *Run*.

After each stage of the operation is completed, the check-box for that stage becomes colored green.

See also the blue progress indicator on the status bar

10. When the operation is completed, all 4 check-boxes will be colored green and the status bar message: *Memory Verify Pass* appears:
If an error message: “Not Finished” shows, click Run again

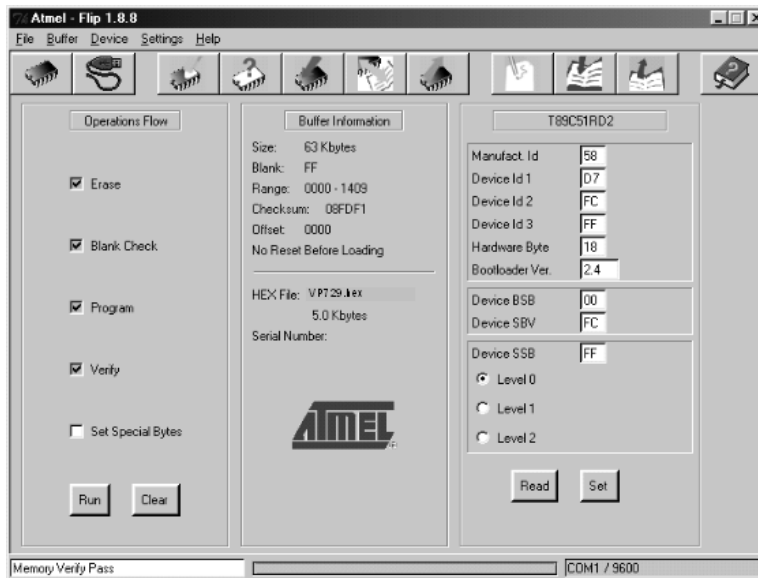

Figure 31: Atmel – Flip Window (Operation Completed)

11. Close the “*Atmel – Flip*” window.
12. Disconnect the power on the VP-728.
13. If required, disconnect the rear panel AUDIO PROG. terminal block connector on the VP-728.
14. Release the rear panel AUDIO PROG. button, using a small screwdriver.
15. Connect the power to the VP-728.
Upon initialization, the new VP-728 **audio** software version shows in the Information menu (see [Figure 22](#)).

10 Technical Specifications

INPUTS:	<p>4 x universal Y/CV, Pb/C, Pr (composite, s-Video and component) 1 Vpp/75Ω on RCA connectors; 2 x UXGA on a 15-pin HD connector (VGA through UXGA) 2 x HDMI connectors 1 x USB connector</p> <p>For each universal input there is a corresponding (unbalanced) audio stereo input (1V nom./ 25kΩ minimum) and digital stereo S/PDIF input (32kHz to 96kHz sample frequency / 75Ω) on RCA connectors For each UXGA input there is a corresponding (unbalanced) audio stereo input on a 3.5mm mini jack connector</p>
OUTPUTS:	<p>1 HDMI connector 1 UXGA format on a 15-pin HD connector 1 unbalanced audio stereo output (1V nom./ 5Ω) on RCA connectors 1 digital stereo S/PDIF output (32kHz to 96kHz sample frequency / 75Ω) on an RCA connector</p>
COMPLIANCE WITH HDMI STANDARD:	Supports HDMI and HDCP
OUTPUT RESOLUTIONS:	<p>Native HDMI, 640x480x60Hz, 640x480x75Hz, 800x600x50Hz, 800x600x60Hz, 800x600x75Hz, 1024x768x50Hz, 1024x768x60Hz, 1024x768x75Hz, 1280x768x50Hz, 1280x768x60Hz, 1280x720x60Hz, 1280x800x60Hz, 1280x1024x50Hz, 1280x1024x60Hz, 1280x1024x75Hz, 1366x768x50Hz, 1366x768x60Hz, 1400x1050x50Hz, 1400x1050x60Hz, 1600x1200x50Hz, 1600x1200x60Hz, 1680x1050x60Hz, 1920x1080x60Hz, 1920x1200x60Hz, 480px60Hz, 576px60Hz, 720px50Hz, 720px60Hz, 1080ix50Hz, 1080ix60Hz, 1080px50Hz, 1080px60Hz, 720x480x59.94Hz, 1280x720x59.94Hz, 1920x1080ix59.94Hz, 1920x1080x23.98Hz, 1920x1080x29.97Hz, 1920x1080x59.94Hz or Custom</p>
CONTROL:	Front panel buttons / OSD, IR remote control, RS-232 on a 9-pin D-sub connector
ADDITIONAL CONTROLS:	Picture-In-Picture: Video-in-Graphics (or vice versa), Picture-and-Picture or Split Screen (two images side-by-side), freeze, zoom, different selectable vertical refresh rates, Video and Audio ProcAmp control, output image scaling and aspect ratio change, EDID capture, text overlay, slide show
POWER SOURCE:	100-240V AC, 50/60Hz, 30VA automatic power supply
DIMENSIONS:	19" (W), 9.3" (D) 1U (H) rack mountable
WEIGHT:	3kg (6.6lbs) approx.
ACCESSORIES:	Null-modem adapter, rack "ears", IR remote control, 2 sets of C-SF/2RVM-0.5 cables, power cord, control application program via RS-232 (PC)
<p>Specifications are subject to change without notice For the most updated resolution list, go to our Web site at http://www.kramerelectronics.com</p>	

Technical Specifications of the RGBHV / RGBS (PC) / RGsB (PC) Input Signal					
Resolution	Vertical Frequency (Hz)	Notes	Resolution	Vertical Frequency (Hz)	Notes
640x480	60		1152x870	75	Mac21
640x480	67	Mac13	1152x900	66	Sun
640x480	72		1152x900	76	Sun
640x480	75		1280x720	60	
640x480	85		1280x800	60	
720x400	70		1280x960	60	
720x400	85		1280x960	85	
800x600	56		1280x768	60	
800x600	60		1280x1024	60	
800x600	72		1280x1024	75	
800x600	75		1280x1024	76	Sun
800x600	85		1280x1024	85	
832x624	75	Mac16	1366x768	60	
1024x768	60		1440x900	60	
1024x768	70		1400x1050	60	
1024x768	75		1400x1050	75	
1024x768	75	Mac19	1600x1200	60	
1024x768	85		1680x1050	60	
1024x800	84	Sun	1920x1080	60	
1152x864	75		1920x1200	60	

Technical Specifications of the HDMI Input Signal (for RGB Colorspace)					
Resolution	Vertical Frequency (Hz)	Notes	Resolution	Vertical Frequency (Hz)	Notes
640x480	60		1152x870	75	Mac21
640x480	67	Mac13	1152x900	66	Sun
640x480	72		1152x900	76	Sun
640x480	75		1280x720	60	
640x480	85		1280x800	60	
720x400	70		1280x960	60	
720x400	85		1280x960	85	
800x600	56		1280x768	60	
800x600	60		1280x1024	60	
800x600	72		1280x1024	75	
800x600	75		1280x1024	76	Sun
800x600	85		1280x1024	85	
832x624	75	Mac16	1366x768	60	
1024x768	60		1400x1050	60	
1024x768	70		1400x1050	75	
1024x768	75		1440x900	60	
1024x768	75	Mac19	1600x1200	60	
1024x768	85		1680x1050	60	
1024x800	84	Sun	1920x1080	60	
1152x864	75		1920x1200	60	

Technical Specifications of the Y/C, Video Signal

Standard	NTSC, NTSC4.43, PAL, PAL-M, PAL-N, SECAM, PAL-60
----------	--

Technical Specifications of the HDMI Signal (for RGB or YUV Colorspace)

Resolution	Vertical Frequency (Hz)	Notes
1080i	60	YPbPr
1080i	50	YPbPr
1080p	60	YPbPr
1080p	50	YPbPr
1080P	24fps	YPbPr
720p	60	YPbPr
720p	50	YPbPr
480i	60	YPbPr
480p	60	YPbPr
576i	50	YPbPr
576p	50	YPbPr

Technical Specifications of the Component Input Signal

Resolution	Vertical Frequency (Hz)	Remark
1080i	60	YPbPr
1080i	50	YPbPr
1080p	60	YPbPr
1080p	50	YPbPr
720p	60	YPbPr
720p	50	YPbPr
480i	60	YPbPr
480p	60	YPbPr
576i	50	YPbPr
576p	50	YPbPr

Technical Specifications of the RGBHV/Comp/YPbPr Output Signal	
Resolution	Vertical Frequency (Hz)
640x480	60
640x480	75
800x600	50
800x600	60
800x600	75
1024x768	50
1024x768	60
1024x768	75
1280x720	60
1280x768	50
1280x768	60
1280x800	60
1280x1024	50
1280x1024	60
1280x1024	75
1366x768	50
1366x768	60
1400x1050	50
1400x1050	60
1600x1200	50
1600x1200	60
1920x1080	60
1920x1200	60
1680x1050	60
1080i	60
1080i	50
720p	60
720p	50
480p	60
576p	50
1080p	50
1080p	60
480p	59.94
720p	59.94
1080i	59.94
1080p	23.98
1080p	29.97
1080p	59.94

Technical Specifications of the HDMI/DVI/RGB Output Signal	
Resolution	Vertical Frequency (Hz)
640x480	60
640x480	75
800x600	50
800x600	60
800x600	75
1024x768	50
1024x768	60
1024x768	75
1280x720	60
1280x768	50
1280x768	60
1280x800	60
1280x1024	50
1280x1024	60
1280x1024	75
1366x768	50
1366x768	60
1400x1050	50
1400x1050	60
1600x1200	50
1600x1200	60
1920x1080	60
1920x1200	60
1680x1050	60
1080i	60
1080i	50
720p	60
720p	50
480p	60
576p	50
1080p	50
1080p	60
1080p	24
480p	59.94
720p	59.94
1080i	59.94
1080p	23.98
1080p	29.97
1080p	59.94

11 VP-728 Communication Protocol

Serial Configuration:

Baud rate: 9600 (Bits per second)

Data bits: 8bits

Parity: None

Stop bits: 1bit

Communication confirmation:

Send: CR

Reply: CR>

Set Command:

Send: Y■Control_Type■Function■Param■CR

Reply: Z■Control_Type■Function■Param■CR>

Get Command:

Send: Y■Control_Type■Function■CR

Reply: Z■Control_Type■Function■Param■CR>

Example: set Input 1 Source Type to Component

Send: Y■0■0■0■CR

Reply: Z■0■0■0■CR>

Example: get current Input 1 Source Type

Send: Y■1■0■CR

Reply: Z■1■0■0■CR >

Definition:

■: ASCII Code 0x20

CR: Ascii Code 0x0D



Go to our Web site at <http://www.kramerelectronics.com> to check for the latest **VP-728** communication protocol.

Control Type		Function	Parameter	Description
Set	Get			
0	1	0	0: Input 1 1: Input 2 2: Input 3 3: Input 4 4: VGA 1 5: VGA 2 6: HDMI 1 7: HDMI 2 8: USB	Input Source
0	1	1	0: Component 1: YC 2: Video	Input 1 Source Type
0	1	2	0: Component 1: YC 2: Video	Input 2 Source Type
0	1	3	0: Component 1: YC 2: Video	Input 3 Source Type
0	1	4	0: Component 1: YC 2: Video	Input 4 Source Type
0	1	5	0: Auto 1: RGB 2: YUV	Input Color Format
0	1	6	0: Auto 1: NTSC 2: PAL 3: PAL-M 4: PAL-N 5: NTSC 4.43 6: SECAM 7: PAL-60	Input Video Standard
0	1	7	1 ~ 50	Input H-Position
0	1	8	2 ~ 50	Input V-Position
0	1	9	0 ~ 50	Input Frequency
0	1	10	0 ~ 31	Input Phase
0	-	11	N/A	Input Auto Image
0	1	12	0~100	Picture Brightness
0	1	13	0~100	Picture Contrast
0	1	14	0~100	Picture Color
0	1	15	0~360	Picture Hue
0	1	16	0~100	Picture Sharpness
0	1	17	0: Gamma 1 1: Gamma 2 2: Gamma 3 3: Gamma 4 4: Gamma 5	Picture Output Gamma
0	1	18	0: Auto 1: Video 2: Film	Picture Film Mode

Control Type		Function	Parameter	Description
Set	Get			
0	1	19	0: Off 1: Low 2: Medium 3: High	Picture Temporal NR
0	1	20	0: Off 1: Low 2: Medium 3: High	Picture Mosquito NR
0	1	21	0: Off 1: On	Picture Block NR
0	1	22	0: Off 1: Low 2: Medium 3: High	Picture Detail Enhancement
0	1	23	0: Off 1: Low 2: High	Picture Luma Transition Enhance
0	1	24	0: Off 1: Low 2: High	Picture Chroma Transition Enhance
0	1	25	0 : Native HDMI 1 : 640x480@60Hz 2 : 640x480@75Hz 3 : 800x600@50Hz 4 : 800x600@60Hz 5 : 800x600@75Hz 6 : 1024x768@50Hz 7 : 1024x768@60Hz 8 : 1024x768@75Hz 9 : 1280x768@50Hz 10: 1280x768@60Hz 11: 1280x720@60Hz 12: 1280x800@60Hz 13: 1280x1024@50Hz 14: 1280x1024@60Hz 15: 1280x1024@75Hz 16: 1366x768@50Hz 17: 1366x768@60Hz 18: 1400x1050@50Hz 19: 1400x1050@60Hz 20: 1600x1200@50Hz 21: 1600x1200@60Hz 22: 1680x1050@60Hz 23: 1920x1080@60Hz 24: 1920x1200@60Hz 25: 480p@60Hz 26: 576p@60Hz 27: 720p@50Hz 28: 720p@60Hz 29: 1080i@50Hz 30: 1080i@60Hz	Output Resolution

Control Type		Function	Parameter	Description
Set	Get			
			31: 1080p@50Hz 32: 1080p@60Hz 33: 480P@59.94Hz 34: 720P@59.94Hz 35: 1080i@59.94Hz 36: 1080P@23.98Hz 37: 1080P@29.97Hz 38: 1080P@59.94Hz 96: Custom1 97: Custom2 98: Custom3 99: Custom4	
0	1	26	0: Auto 1: HDMI 2: DVI	Output HDMI Type
0	1	27	0: Best Fit 1: Letterbox 2: Follow Output 3: Virtual Wide 4: Follow Input 5: Custom	Aspect Ratio
0	1	28	-16 ~ 16	H-Pan
0	1	29	-16 ~ 16	V-Pan
0	1	30	-8 ~ 8	H-Zoom
0	1	31	-8 ~ 8	V-Zoom
0	1	32	0: 100% 1: 150% 2: 200% 3: 225% 4: 250% 5: 275% 6: 300% 7: 325% 8: 350% 9: 375% 10: 400% 11: Custom	Zoom
0	1	33	0 ~ 32	Custom Zoom
0	1	34	0 ~ 31	Zoom H-Pan
0	1	35	0 ~ 31	Zoom V-Pan
0	1	36	0: Off 1: On	PIP On/Off
0	1	37	0: Picture-In-Picture 1: Picture + Picture 2: Split	PIP Type
0	1	38	0: Input 1 1: Input 2 2: Input 3 3: Input 4 4: VGA 1 5: VGA 2 6: HDMI 1	PIP Source

Control Type		Function	Parameter	Description
Set	Get			
			7: HDMI 2	
0	1	39	0: 1/25 1: 1/16 2: 1/9 3: 1/4 4: Custom	PIP Size
0	1	40	0 ~ 128	PIP H-Position
0	1	41	0 ~ 128	PIP V-Position
0	1	42	1 ~ 256	PIP H-Size
0	1	43	1 ~ 256	PIP V-Size
0	1	44	0: Off 1: On	PIP Frame
0	1	45	0: Red 1: Green 2: Blue	PIP Frame Color
0	1	46	0: Analog 1: S/PDIF	Audio Input Type
0	1	47	-22~0~+22	Audio Input Volume
0	1	48	-100~24	Audio Output Volume
0	-		111	Volume Up
0	-		-111	Volume Down
0	1	49	-36~0~+36	Audio Bass
0	1	50	-36~0~+36	Audio Treble
0	1	51	-10~10	Audio Balance
0	1	52	0: Off 1: On	Audio Loudness
0	1	53	0: Dynamic 1: User Define	Audio Delay
	1	54	0~340 (2msec steps)	User Delay
0	1	55	0: No audio 1: Input 1 2: Input 2 3: Input 3 4: Input 4 5: VGA1 6: VGA2 7: HDMI1 8: HDMI2	Audio Input For USB
0	1	56	0: Keystone 1: Anyplace 2: Rotation	Geometry Application
0	1	57	0: Front 1: Ceiling 2: Rear 3: Rear ceiling	Geometry Location
0	1	58	-40 ~ 40	Geometry Horizontal Keystone
0	1	59	-30~30	Geometry Vertical Keystone
0	1	60	-2000~2000	Geometry Diagonal Projection – Top Left H
0	1	61	-2000~2000	Geometry Diagonal Projection – Top Left V

Control Type		Function	Parameter	Description
Set	Get			
0	1	62	-2000~2000	Geometry Diagonal Projection – Top Right H
0	1	63	-2000~2000	Geometry Diagonal Projection – Top Right V
0	1	64	-2000~2000	Geometry Diagonal Projection – Bottom Left H
0	1	65	-2000~2000	Geometry Diagonal Projection – Bottom Left V
0	1	66	-2000~2000	Geometry Diagonal Projection – Bottom Right H
0	1	67	-2000~2000	Geometry Diagonal Projection – Bottom Right V
0	-	68	N/A	Geometry Diagonal Projection – Reset
0	1	69	-20 ~ 20	Geometry Pincushion/Barrel
0	1	70	-180 ~ 180	Geometry Rotation
0	-	71	N/A	Geometry Reset all
0	-	72	0: Profile 1 1: Profile 2 2: Profile 3 3: Profile 4 4: Profile 5 5: Profile 6 6: Profile 7 7: Profile 8	Save Setting
0	-	73	0: Profile 1 1: Profile 2 2: Profile 3 3: Profile 4 4: Profile 5 5: Profile 6 6: Profile 7 7: Profile 8	Recall Setting
0	1	74	0: Off 1: On	Frame Lock
0	-	75	N/A	Factory Reset
-	1	76	N/A	Firmware Revision
0	1	77	0: 1400x1050x60 1: 1680x1050x60	Mode Set – Mode 1
0	1	78	0: 1280x1024x75 1: 1280x1024x76	Mode Set – Mode 2
0	1	79	0: Center 1: Top Left 2: Top Right 3: Bottom Left 4: Bottom Right	OSD Menu Position
0	1	80	0: 5 sec 1: 10 sec 2: 20 sec 3: 30 sec 4: 60 sec 5: 90 sec 6: Off	OSD Time Out
0	1	81	0: Off 1: On 2: Custom	Logo

Control Type		Function	Parameter	Description
Set	Get			
0	1	82	0: Black 1: Blue	Blank Color
0	-	83	N/A	Capture
0	1	84	0: Black 1: Blue 2: Custom 3: Disable Analog Sync	Background
0	1	85	0: Off 1: On	Save Lock
0	1	86	0: Off 1: On	Input Lock
0	1	87	0: Blank & Mute 1: Blank 2: Mute	Blank key function
0	1	88	0: Freeze & Mute 1: Freeze 2: Mute	Freeze key function
0	1	89	0: Off 1: On	Freeze
0	1	90	0: Off 1: On	Blank
0	1	91	0: Off 1: On	Power
0	-	92	N/A	Info
0	-	93	N/A	Menu
0	-	94	N/A	Top
0	-	95	N/A	Down
0	-	96	N/A	Left
0	-	97	N/A	Right
0	-	98	N/A	Enter
0	-	99	N/A	Picture
0	-	100	N/A	Swap
0	1	101	0: Off 1: On	Mute
0	1	102	0: Off 1: On	Lock
-	1	103	0: 640x480 60 1: 640x480 67 Mac13 2: 640x480 72 3: 640x480 75 4: 640x480 85 5: 720x400 70 6: 720x400 85 7: 800x600 56 8: 800x600 60 9: 800x600 72 10: 800x600 75 11: 800x600 85 12: 832x624 75 Mac16	Main Input status

Control Type		Function	Parameter	Description
Set	Get			
			13: 1024x768 60	
			14: 1024x768 70	
			15: 1024x768 75	
			16: 1024x768 75 Mac19	
			17: 1024x768 85	
			18: 1024x800 84 Sun	
			19: 1152x864 75	
			20: 1152x870 75 Mac21	
			21: 1152x900 66 Sun	
			22: 1152x900 76 Sun	
			23: 1280x960 60	
			24: 1280x960 85	
			25: 1280x768 60	
			26: 1280x1024 60	
			27: 1280x1024 75	
			28: 1280x1024 76 Sun	
			29: 1280x1024 85	
			30: 1400x1050 60	
			31: 1400x1050 75	
			32: 1600x1200 60	
			33: 1680x1050 60	
			34: 1080i 60	
			35: 1080i 50	
			36: 1080p 60	
			37: 1080p 50	
			38: 720p 60	
			39: 720p 50	
			40: 480i	
			41: 480p	
			42: 576i	
			43: 576p	
			44: 1280x800 60 (Reduce blank)	
			45: 1920x1200 60	
			46: 1920x1080 60	
			47: 1280x720 60	
			48: 1080p 24	
			49: 1280x800 60	
			50: 1440x900 60	
			51: 1440x900 60(Reduced blanking)	
			52: 1280x768_60 (Reduced blanking)	
			53: 1680x1050 60(Reduce blank)	
			54: 1366x768 60	
			55: 1366x768_60 (Reduce blank)	
			94: Custom1	
			95: Custom2	
			96: Custom3	
			97: Custom4	

Control Type		Function	Parameter	Description
Set	Get			
			98: No Input detected 99: other 101: NTSC 102: PAL 103: PAL-M 104: PAL-N 105: NTSC 4.43 106: SECAM 107: PAL-60	
-	1	104	0: 640x480 60 1: 640x480 67 Mac13 2: 640x480 72 3: 640x480 75 4: 640x480 85 5: 720x400 70 6: 720x400 85 7: 800x600 56 8: 800x600 60 9: 800x600 72 10: 800x600 75 11: 800x600 85 12: 832x624 75 Mac16 13: 1024x768 60 14: 1024x768 70 15: 1024x768 75 16: 1024x768 75 Mac19 17: 1024x768 85 18: 1024x800 84 Sun 19: 1152x864 75 20: 1152x870 75 Mac21 21: 1152x900 66 Sun 22: 1152x900 76 Sun 23: 1280x960 60 24: 1280x960 85 25: 1280x768 60 26: 1280x1024 60 27: 1280x1024 75 28: 1280x1024 76 Sun 29: 1280x1024 85 30: 1400x1050 60 31: 1400x1050 75 32: 1600x1200 60 33: 1680x1050 60 34: 1080i 60 35: 1080i 50 36: 1080p 60 37: 1080p 50 38: 720p 60 39: 720p 50 40: 480i 41: 480p 42: 576i	PIP Input status

Control Type		Function	Parameter	Description
Set	Get			
			43: 576p 44: 1280x800 60 (Reduce blank) 45: 1920x1200 60 46: 1920x1080 60 47: 1280x720 60 48: 1080p 24 49: 1280x800 60 50: 1440x900 60 51: 1440x900 60(Reduced blanking) 52: 1280x768_60 (Reduced blanking) 52: 1280x768_60 (Reduce blank) 53: 1680x1050 60(Reduce blank) 54: 1366x768 60 55: 1366x768_60 (Reduce blank) 94: Custom1 95: Custom2 96: Custom3 97: Custom4 98: No Input detected 99: other 101: NTSC 102: PAL 103: PAL-M 104: PAL-N 105: NTSC 4.43 106: SECAM 107: PAL-60	
0	1	105	512~3071	Advance Input Mode: HT
0	1	106	32~(HS-48)	Advance Input Mode: HW
0	1	107	80~(HT-HA-12)	Advance Input Mode: HS
0	1	108	640~1920 <= (HT-92)	Advance Input Mode: HA
0	1	109	0: Negative polarity 1: Positive polarity	Advance Input Mode: HP
0	1	110	384~2047	Advance Input Mode: VT
0	1	111	2~(HS-13)	Advance Input Mode: VW
0	1	112	15~(VT-VA-1)	Advance Input Mode: VS
0	1	113	480~1200 <= (VT-16)	Advance Input Mode: VA
0	1	114	0: Negative polarity 1: Positive polarity	Advance Input Mode: VP
0	1	115	25 < OCLK < 165	Advance Input Mode: OCLK(Integer)
0	1	116	25 < OCLK < 165	Advance Input Mode: OCLK(Decimal)
0	1	117	0: Off	Advance Input Mode: Enable

Control Type		Function	Parameter	Description
Set	Get			
			1: On	
0	-	118	N/A	Advance Input Mode: Save
0	1	119	512~3071	Advance Output Mode: HT
0	1	120	32~(HS-48)	Advance Output Mode: HW
0	1	121	80~(HT-HA-12)	Advance Output Mode: HS
0	1	122	640~1920 <= (HT-92)	Advance Output Mode: HA
0	1	123	0: Negative polarity 1: Positive polarity	Advance Output Mode: HP
0	1	124	384~2047	Advance Output Mode: VT
0	1	125	2~(HS-13)	Advance Output Mode: VW
0	1	126	15~(VT-VA-1)	Advance Output Mode: VS
0	1	127	480~1200 <= (VT-16)	Advance Output Mode: VA
0	1	128	0: Negative polarity 1: Positive polarity	Advance Output Mode: VP
0	1	129	25 < OCLK < 165	Advance Output Mode: OCLK(Integer)
0	1	130	25 < OCLK < 165	Advance Output Mode: OCLK(Decimal)
0	-	131	N/A	Advance Output Mode: Save
0	-	132	N/A	Advance Output Mode: Set Current
0	-	133	N/A	Volume Up
0	-	134	n/a	Volume Down
0	1	135	0: Follow Output 1: Follow Input	HDCP Setting
0	1	136	0:Custom1 1:Custom2 2:Custom3 3:Custom4	Advance Input Mode: Custom Input
0	1	137	0:Custom1 1:Custom2 2:Custom3 3:Custom4	Advance Output Mode: Custom Output
0	1	138	0: Off 1: On	Overscan
0	1	139	0: Seamless 1: Fast	Switching Mode
0	1	140	0: Manual 1: Auto	Auto Image Mode
0	-	141	N/A	Slideshow Start
0	-	142	N/A	Slideshow Stop
0	-	143	N/A	Slideshow Pause
0	-	144	N/A	Slideshow Next
0	-	145	N/A	Slideshow Previous
0	1	146	0: Min 1: Low 2: Mid	Slideshow

Control Type		Function	Parameter	Description
Set	Get			
			3: Long 4: Max 5: Off	
0	1	147	0: 1280x768x60 1: 1366x768x60	Mode Set – Mode 3
0	1	148	0 : Normal 1 : Bypass	HDMI1 Switching Behavior
0	1	149	0 : Normal 1 : Bypass	HDMI2 Switching Behavior
0	1	150	0 : Input 1 1 : Input 2 2 : Input 3 3 : Input 4 4 : VGA 1 5 : VGA 2 6 : HDMI 1	HDMI1 Audio Input
0	1	151	0 : Input 1 1 : Input 2 2 : Input 3 3 : Input 4 4 : VGA 1 5 : VGA 2 6 : HDMI 2	HDMI2Audio Input
0	-	152	-	Custom Output Read HDMI EDID Prefer Timing
0	1	153	0 : Off 1 : On	HDMI1 Input HDCP On/Off
0	1	154	0 : Off 1 : On	HDMI2Input HDCP On/Off

11.1 Error Codes Description

Error code	Description
ERR 1	Unknown command
ERR 2	Unknown function
ERR 3	Unavailable function
ERR 4	Unknown control type
ERR 5	Unavailable get function
ERR 6	Unavailable set function
ERR 7	Unavailable parameter
ERR 8	Too few arguments

LIMITED WARRANTY

The warranty obligations of Kramer Electronics for this product are limited to the terms set forth below:

What is Covered

This limited warranty covers defects in materials and workmanship in this product.

What is Not Covered

This limited warranty does not cover any damage, deterioration or malfunction resulting from any alteration, modification, improper or unreasonable use or maintenance, misuse, abuse, accident, neglect, exposure to excess moisture, fire, improper packing and shipping (such claims must be presented to the carrier), lightning, power surges, or other acts of nature. This limited warranty does not cover any damage, deterioration or malfunction resulting from the installation or removal of this product from any installation, any unauthorized tampering with this product, any repairs attempted by anyone unauthorized by Kramer Electronics to make such repairs, or any other cause which does not relate directly to a defect in materials and/or workmanship of this product. This limited warranty does not cover cartons, equipment enclosures, cables or accessories used in conjunction with this product.

Without limiting any other exclusion herein, Kramer Electronics does not warrant that the product covered hereby, including, without limitation, the technology and/or integrated circuit(s) included in the product, will not become obsolete or that such items are or will remain compatible with any other product or technology with which the product may be used.

How Long Does this Coverage Last

Seven years as of this printing; please check our Web site for the most current and accurate warranty information.

Who is Covered

Only the original purchaser of this product is covered under this limited warranty. This limited warranty is not transferable to subsequent purchasers or owners of this product.

What Kramer Electronics will do

Kramer Electronics will, at its sole option, provide one of the following three remedies to whatever extent it shall deem necessary to satisfy a proper claim under this limited warranty:

1. Elect to repair or facilitate the repair of any defective parts within a reasonable period of time, free of any charge for the necessary parts and labor to complete the repair and restore this product to its proper operating condition. Kramer Electronics will also pay the shipping costs necessary to return this product once the repair is complete.
2. Replace this product with a direct replacement or with a similar product deemed by Kramer Electronics to perform substantially the same function as the original product.
3. Issue a refund of the original purchase price less depreciation to be determined based on the age of the product at the time remedy is sought under this limited warranty.

What Kramer Electronics will not do Under This Limited Warranty

If this product is returned to Kramer Electronics or the authorized dealer from which it was purchased or any other party authorized to repair Kramer Electronics products, this product must be insured during shipment, with the insurance and shipping charges prepaid by you. If this product is returned uninsured, you assume all risks of loss or damage during shipment. Kramer Electronics will not be responsible for any costs related to the removal or re-installation of this product from or into any installation. Kramer Electronics will not be responsible for any costs related to any setting up this product, any adjustment of user controls or any programming required for a specific installation of this product.

How to Obtain a Remedy under this Limited Warranty

To obtain a remedy under this limited warranty, you must contact either the authorized Kramer Electronics reseller from whom you purchased this product or the Kramer Electronics office nearest you. For a list of authorized Kramer Electronics resellers and/or Kramer Electronics authorized service providers, please visit our web site at www.kramerelectronics.com or contact the Kramer Electronics office nearest you.

In order to pursue any remedy under this limited warranty, you must possess an original, dated receipt as proof of purchase from an authorized Kramer Electronics reseller. If this product is returned under this limited warranty, a return authorization number, obtained from Kramer Electronics, will be required. You may also be directed to an authorized reseller or a person authorized by Kramer Electronics to repair the product.

If it is decided that this product should be returned directly to Kramer Electronics, this product should be properly packed, preferably in the original carton, for shipping. Cartons not bearing a return authorization number will be refused.

Limitation on Liability

THE MAXIMUM LIABILITY OF KRAMER ELECTRONICS UNDER THIS LIMITED WARRANTY SHALL NOT EXCEED THE ACTUAL PURCHASE PRICE PAID FOR THE PRODUCT. TO THE MAXIMUM EXTENT PERMITTED BY LAW, KRAMER ELECTRONICS IS NOT RESPONSIBLE FOR DIRECT, SPECIAL, INCIDENTAL OR CONSEQUENTIAL DAMAGES RESULTING FROM ANY BREACH OF WARRANTY OR CONDITION, OR UNDER ANY OTHER LEGAL THEORY. Some countries, districts or states do not allow the exclusion or limitation of relief, special, incidental, consequential or indirect damages, or the limitation of liability to specified amounts, so the above limitations or exclusions may not apply to you.

Exclusive Remedy

TO THE MAXIMUM EXTENT PERMITTED BY LAW, THIS LIMITED WARRANTY AND THE REMEDIES SET FORTH ABOVE ARE EXCLUSIVE AND IN LIEU OF ALL OTHER WARRANTIES, REMEDIES AND CONDITIONS, WHETHER ORAL OR WRITTEN, EXPRESS OR IMPLIED. TO THE MAXIMUM EXTENT PERMITTED BY LAW, KRAMER ELECTRONICS SPECIFICALLY DISCLAIMS ANY AND ALL IMPLIED WARRANTIES, INCLUDING, WITHOUT LIMITATION, WARRANTIES OF MERCHANTABILITY AND FITNESS FOR A PARTICULAR PURPOSE. IF KRAMER ELECTRONICS CANNOT LAWFULLY DISCLAIM OR EXCLUDE IMPLIED WARRANTIES UNDER APPLICABLE LAW, THEN ALL IMPLIED WARRANTIES COVERING THIS PRODUCT, INCLUDING WARRANTIES OF MERCHANTABILITY AND FITNESS FOR A PARTICULAR PURPOSE, SHALL APPLY TO THIS PRODUCT AS PROVIDED UNDER APPLICABLE LAW.

IF ANY PRODUCT TO WHICH THIS LIMITED WARRANTY APPLIES IS A "CONSUMER PRODUCT" UNDER THE MAGNUSON-MOSS WARRANTY ACT (15 U.S.C.A. §2301, ET SEQ.) OR OTHER APPLICABLE LAW, THE FOREGOING DISCLAIMER OF IMPLIED WARRANTIES SHALL NOT APPLY TO YOU, AND ALL IMPLIED WARRANTIES ON THIS PRODUCT, INCLUDING WARRANTIES OF MERCHANTABILITY AND FITNESS FOR THE PARTICULAR PURPOSE, SHALL APPLY AS PROVIDED UNDER APPLICABLE LAW.

Other Conditions

This limited warranty gives you specific legal rights, and you may have other rights which vary from country to country or state to state.

This limited warranty is void if (i) the label bearing the serial number of this product has been removed or defaced, (ii) the product is not distributed by Kramer Electronics or (iii) this product is not purchased from an authorized Kramer Electronics reseller. If you are unsure whether a reseller is an authorized Kramer Electronics reseller, please visit our Web site at www.kramerelectronics.com or contact a Kramer Electronics office from the list at the end of this document.

Your rights under this limited warranty are not diminished if you do not complete and return the product registration form or complete and submit the online product registration form. Kramer Electronics thanks you for purchasing a Kramer Electronics product. We hope it will give you years of satisfaction.



For the latest information on our products and a list of Kramer distributors, visit our Web site where updates to this user manual may be found.

We welcome your questions, comments, and feedback.

Web site: www.kramerelectronics.com

E-mail: info@kramereel.com



SAFETY WARNING

Disconnect the unit from the power supply before opening and servicing



P/N: 2900-000363



Rev: 9