

2370A

FLAT-FRONT
BI-RADIAL™ HORN



FEATURES:

90° x 40° nominal dispersion

Uniform horizontal on and off axis frequency response

Precise horizontal pattern control

Full horn loading to 630 Hz

Flat front, compact size, and lightweight construction

25 mm (1 in) throat entry

The JBL Model 2370A is a compact Bi-Radial™ horn with a nominal coverage pattern of 90° horizontal x 40° vertical. The horn provides uniform on and off axis frequency response in the horizontal plane from 630 Hz to beyond 16 kHz. The horn's small vertical mouth dimension was chosen to allow a gradual narrowing of the vertical coverage pattern

with increasing frequency. This provides acoustic equalization of the frequency response of the horn in the horizontal plane and compensates for the falling power response of all compression drivers. Should constant vertical pattern control be required, two or more 2370As may be stacked to restore full Bi-Radial™ performance.

The horn's exceptionally consistent horizontal dispersion eliminates the midrange narrowing and high frequency beaming problems typically associated with conventional horn designs. Additionally, the 2370A's highly predictable performance greatly simplifies cluster design. The need for horn overlapping is minimized and lobing and comb filter effects are virtually eliminated.

JBL

Computer aided design techniques were used to derive the horn contours in the horizontal and vertical planes. Utilizing sidewall contours based on a polynomial power series formula, the horn design yields smooth response, low distortion, and even coverage. This design avoids the performance disadvantages of horns that feature sharp flare transitions and flat sidewalls. The Bi-Radial™ compound flare configuration of the horn provides constant coverage over defined, solid angles.

The 2370A features an integral throat that will accept any JBL compression driver having a 25 mm (1 in) throat diameter. The flat front design of the horn allows flush mounting on enclosure baffles. Mounting tabs are provided for enclosure or cluster mounting. To ensure freedom from resonances, light weight, and superior strength, the horn belt is constructed of molded structural foam.

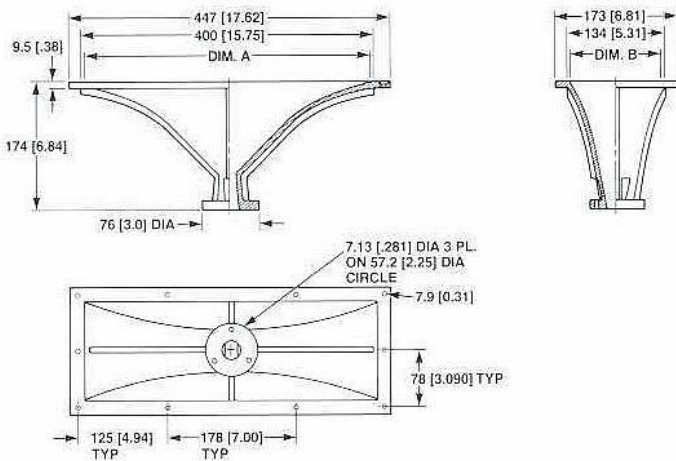

SPECIFICATIONS:

Coverage:	Angle (-6 dB)	Frequency
Horizontal:	90° (+10°, -15°)	630 Hz - 16 kHz
Vertical:	112°	1 kHz
	69°	2 kHz
	42°	4 kHz
	28°	8 kHz
	21°	16 kHz
Directivity:		
Directivity Factor (Q):	12.2 (+10.1, -5.2)	
Directivity Index (DI):	10.9 dB (+2.6, -2.4)	
Average Range:	1 kHz - 16 kHz	
Usable Low Frequency Limit:	500 Hz	
Minimum Recommended Crossover Frequency:	630 Hz	
Axial Pressure Sensitivity:	110 dB SPL, 1 W @ 1 m	
Construction:	Injection molded reinforced high-density solid polyurethane	
Overall Dimensions:		
Mouth Height:	173 mm (6.81 in)	
Mouth Width:	445 mm (17.5 in)	
Length:	174 mm (6.84 in)	
Mounting Dimensions:		
Rear Height:	135 mm (5.31 in)	
Rear Width:	400 mm (15.75 in)	
Baffle Cutout Required (Front mounting only)		
Height:	138 mm (5.44 in)	
Width:	403 mm (15.88 in)	
Net Weight:	1.4 kg (3 lb)	
Shipping Weight:	2.3 kg (5 lb)	

1. Measured on axis in the far field with 1 watt (2.83 V RMS; 8 ohms) input and referenced to 1 meter distance using the inverse square law. Listed sound pressure represents an average from 1 kHz to 4 kHz using the JBL Model 2425H driver.

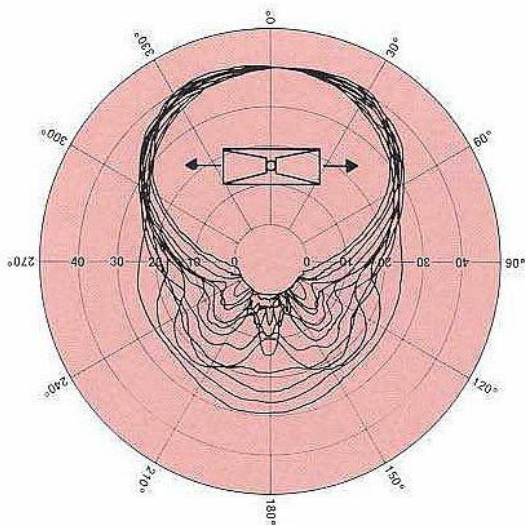

Composite 1/3-octave polar bandwidth responses of the 2370A in the horizontal plane over the range of 800 Hz to 16 kHz (1 meter measurement distance in an anechoic chamber, all polars normalized to on axis).

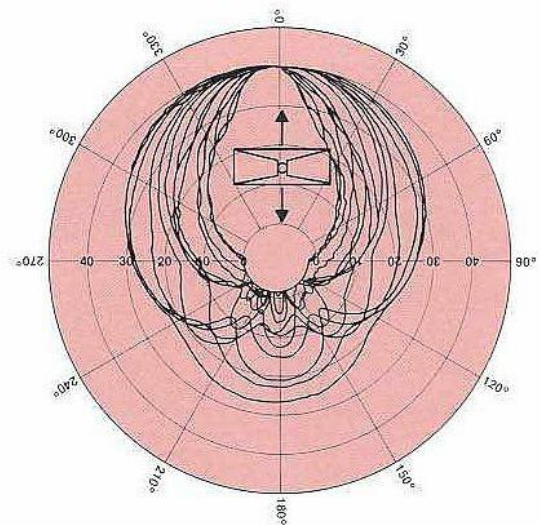

Composite polar responses of the 2370A in the vertical plane. Same test conditions as horizontal. Note gradual narrowing of coverage pattern at higher frequencies. This allows the horn to acoustically self equalize.

Beamwidth vs Frequency, 2370

Beamwidth vs. Frequency

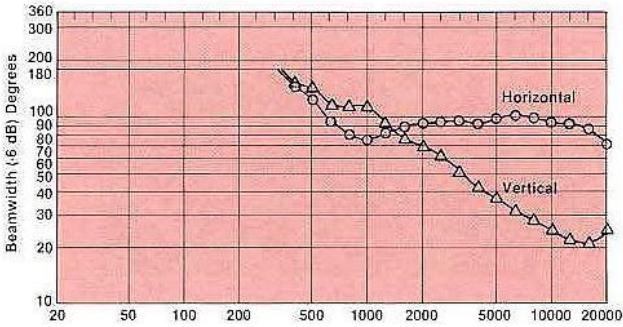

Directivity vs. Frequency

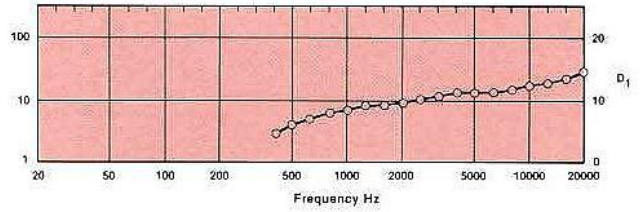

Frontal Isobar Contours

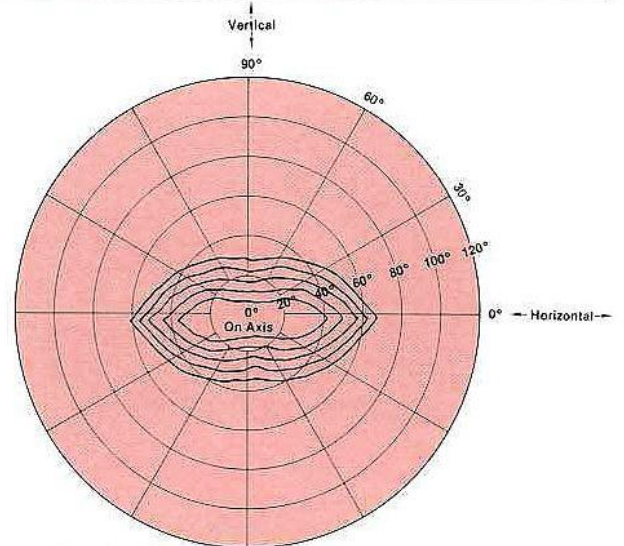
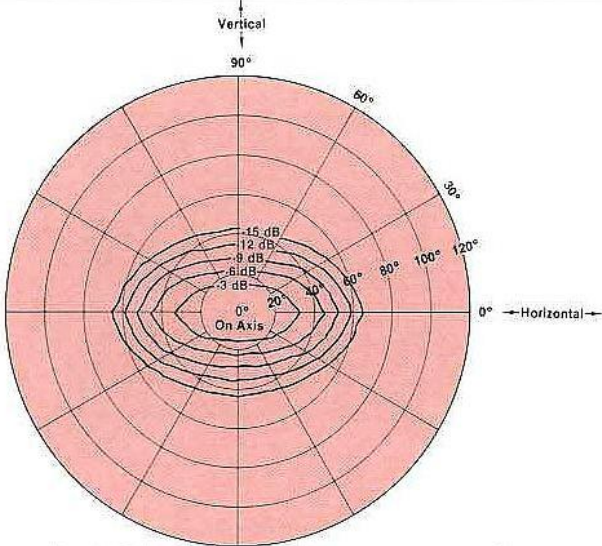

1 kHz octave bandwidth constant sound pressure contours of 0 to -15 dB in steps of -3 dB. The contours are plotted on polar grid lines with on axis being the center of the plot. The data was gathered by taking an octave polar plot at all oblique angles from 0° (horizontal) to 90° (vertical) in steps of 15°. Same test conditions as horizontal polar response.

2 kHz octave bandwidth constant sound pressure contours. Same conditions as 1 kHz contours.

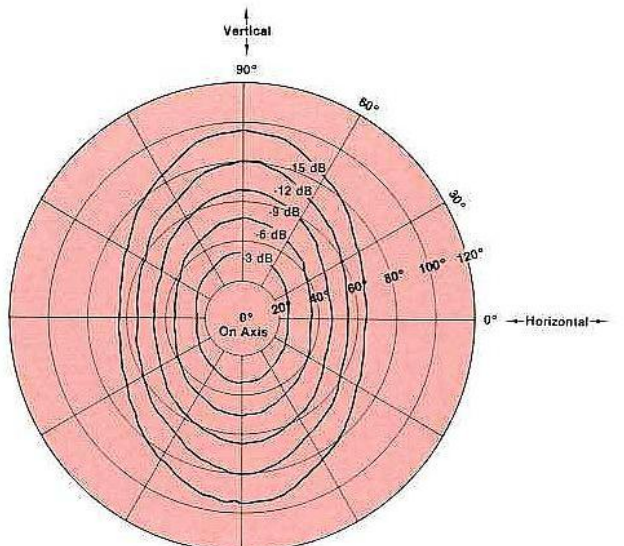
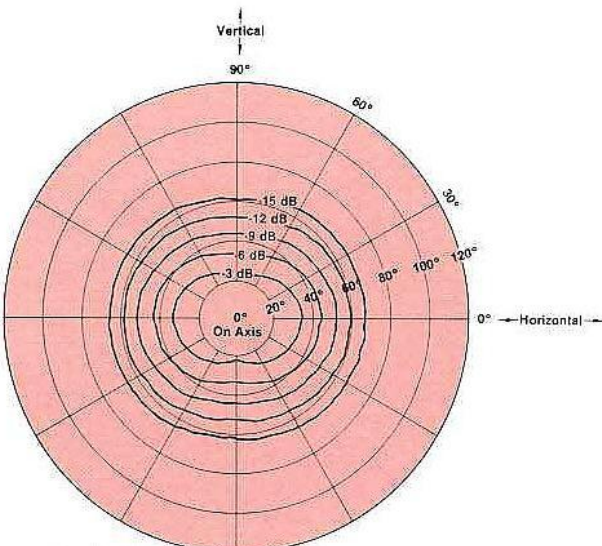

4 kHz octave bandwidth constant sound pressure contours. Same conditions as 1 kHz contours.

8 kHz octave bandwidth constant sound pressure contours. Same conditions as 1 kHz contours.

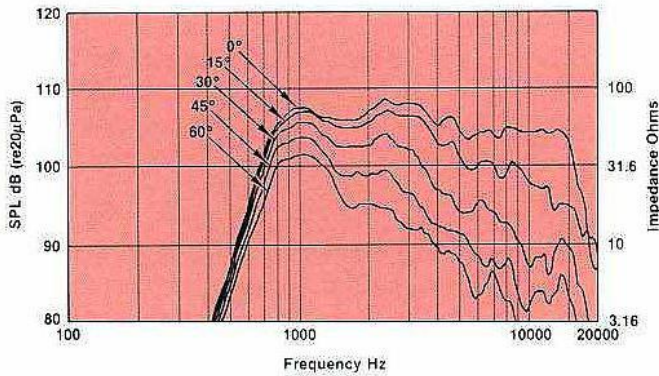

Horizontal Off-Axis Response

Horizontal off-axis response taken at 15 degree intervals out to 60 degrees off axis.

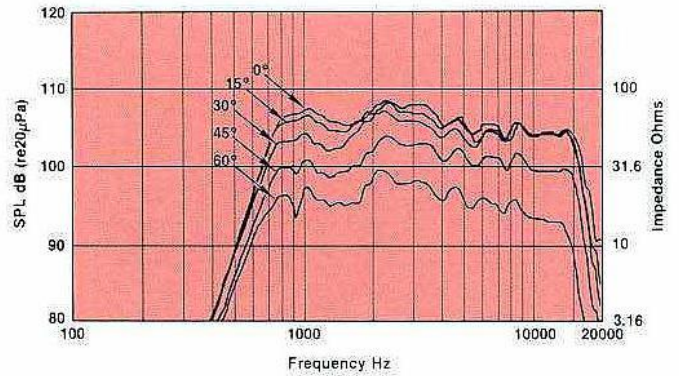

Vertical Off-Axis Response

Vertical off-axis response taken at 15 degree intervals out to 60 degrees off axis.

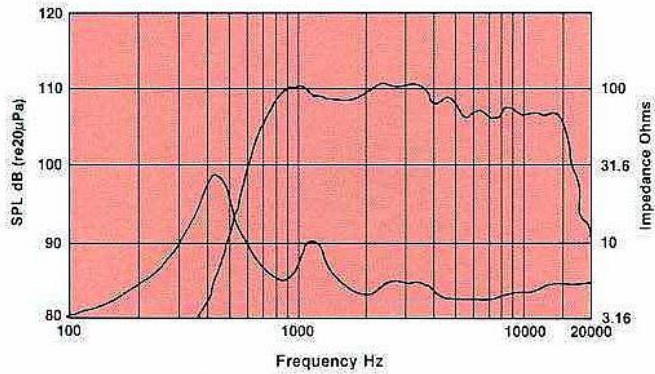

Frequency Response and Impedance

Frequency response of the 2370A, measured on axis at a distance of 1 meter with 1 watt (2.83 V RMS) applied to a JBL Model 2425 H compression driver, in a reflection-free environment, with impedance vs frequency curve.

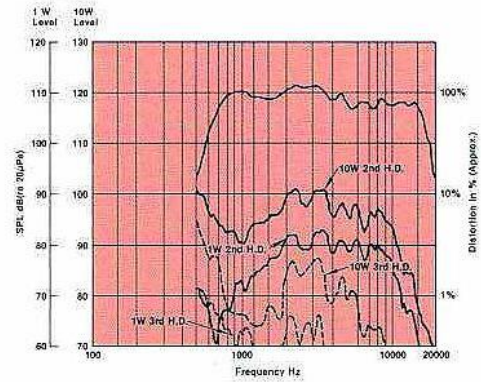

Harmonic Distortion

Second and third harmonic distortion curves of the 2370A with 1 watt (2.83 V RMS) and 10 watts (8.94 V RMS) applied to the JBL Model 2425H compression driver. Measured on axis at a distance of 1 meter in a reflection-free environment.

JBL continually engages in research related to product improvement. New materials, production methods, and design refinements are introduced into existing products without notice as a routine expression of that philosophy. For this reason, any current JBL product may differ in some respect from its published description but will always equal or exceed the original design specifications unless otherwise stated.

