

LINEAR 9

LINEAR 9 210 LTA • LINEAR 9 110 XA • LINEAR 9 112 XA
LINEAR 9 118 Sub A • LINEAR 9 118 Sub BA

Manual 1.0



Important Safety Instructions! Read before connecting!

This product has been built by the manufacturer in accordance with IEC 62368-1 and left the factory in safe working order. To maintain this condition and ensure non-risk operation, the user must follow the advice and warning comments found in the operating instructions. If this product shall be used in vehicles, ships or aircraft or at altitudes exceeding 2000 m above sea level, take care of the relevant safety regulations which may exceed the IEC 62368-1 requirements. **WARNING:** To prevent the risk of fire and shock hazard, do not expose this appliance to moisture or rain. Do not open case – no user serviceable parts inside. Refer service to qualified service personnel.



This symbol, wherever it appears, alerts you to the presence of uninsulated dangerous voltage inside the enclosure – voltage that may be sufficient to constitute a risk of shock.



This symbol, wherever it appears, alerts you to the presence of externally accessible hazardous voltage. External wiring connected to any terminal marked with this symbol must be a “ready made cable” complying with the manufacturers recommendations, or must be a wiring installed by instructed persons only.



This symbol, wherever it appears, alerts you to important operating and maintenance instructions in the accompanying literature. Read the manual.



This symbol, wherever it appears, tells you: Take care! Hot surface! To prevent burns you must not touch.



All electrical and electronic products including batteries should be disposed of separately from the municipal waste stream via designated collection facilities appointed by the government or the local authorities.



Read these instructions. Keep these instructions. Follow all warnings and instructions marked on the product and in this manual.

- Do not use this product near water. Do not place the product near water, baths, wash basins, kitchen sinks, wet areas, swimming pools or damp rooms.
- Do not place objects containing liquid on the product – vases, glasses, bottles etc.
- Clean only with dry cloth.
- Do not remove any covers or sections of the housing.
- The set operating voltage of the product must match the local mains supply voltage. If you are not sure of the type of power available consult your dealer or local power company.
- Before connecting the device, please ensure that the mains supply you are using is equipped with adequate protection against short circuiting and grounding faults when the device is plugged in.
- To reduce the risk of electrical shock, the grounding of this product must be maintained. Use only the power supply cord provided with this product, and maintain the function of the center (grounding) pin of the mains connection at any time. Make sure the mains outlet used provides a proper protective ground connection.
- Do not defeat the safety purpose of the polarized or grounding-type plug. A polarized plug has two blades with one wider than the other. A grounding type plug has two blades and a third grounding prong. The wide blade or the third prong are provided for your safety. If the provided plug does not fit into your outlet, consult an electrician for replacement of the obsolete outlet.
- Protect the power cord from being walked on or pinched particularly at plugs, convenience receptacles, and the point where they exit from the device! Power supply cords should always be handled carefully. Periodically check cords for cuts or sign of stress, especially at the plug and the point where the cord exits the device.
- Never use a damaged power cord.
- Unplug this product during lightning storms or when unused for long periods of time.
- This product can be fully disconnected from mains only by pulling the mains plug at the unit or the wall socket. The product must be placed in such a way at any time, that disconnecting from mains is easily possible.

- Fuses are to be replaced exclusively by qualified personnel, and then only with fuses of the proper type and rating.
- Refer all servicing to qualified service personnel. Servicing is required when the unit has been damaged in any way, such as:
 - When the power cord or plug is damaged or frayed.
 - If liquid has been spilled or objects have fallen into the product.
 - If the product has been exposed to rain or moisture.
 - If the product does not operate normally when the operating instructions are followed.
 - If the product has been dropped or the cabinet has been damaged.
- Do not connect external speakers to this product with an impedance lower than the rated impedance given on the product or in this manual. Use only cables with sufficient cross section according to the local safety regulations.
- Keep away from direct sunlight.
- Do not install near heat sources such as radiators, heat registers, stoves or other devices that produce heat.
- This apparatus is for moderate climates areas use, not suitable for use in tropical climates countries.
- Do not block any ventilation openings. Install in accordance with manufacturer's instructions. This product must not be placed in a built-in installation such as a rack unless proper ventilation is provided.
- Always allow a cold device to warm up to ambient temperature, when being moved into a room. Condensation can form inside it and damage the product, when being used without warming up.
- Do not place naked flame sources, such as lighted candles on the product.
- The device must be positioned at least 20 cm/8" away from walls.
- Use only with the cart, stand, tripod, bracket or table specified by the manufacturer or sold with the product. When a cart is used, use caution when moving the cart/product combination to avoid injury from tip-over.
- Use only accessories recommended by the manufacturer, this applies for all kind of accessories, for example protective covers, transport bags, stands, wall or ceiling mounting equipment. In case of attaching any kind of accessories to the product, always follow the instructions for use, provided by the manufacturer. Never use fixing points on the product other than specified by the manufacturer.
- This appliance is NOT suitable to be used by any person or persons (including children) with limited physical, sensorial or mental ability, or by persons with insufficient experience and/or knowledge to operate such an appliance. Children under 4 years of age must be kept away from this appliance at all times.
- Never push objects of any kind into this product through cabinet slots as they may touch dangerous voltage points or short out parts that could result in risk of fire or electric shock.
- This product is capable of delivering sound pressure levels in excess of 90 dB, which may cause permanent hearing damage! Exposure to extremely high noise levels may cause a permanent hearing loss. Wear hearing protection if continuously exposed to such high levels.
- The manufacturer only guarantees the safety, reliability and efficiency of this product if:
 - Assembly, extension, re-adjustment, modifications or repairs are carried out by the manufacturer or by persons authorized to do so.
 - The electrical installation of the relevant area complies with the requirements of IEC (ANSI) specifications.
 - The unit is used in accordance with the operating instructions.
- This product is optimized for use with music and speech signals. Using this product with sine wave, square wave or other kind of measuring signals at higher level may lead to severe damage of the product.

General Notes on Safety for Loudspeaker Systems



Mounting systems may only be used for those loudspeaker systems authorized by the manufacturer and only with the mounting accessories specified by the manufacturer in the installation instructions. Read and heed the manufacturer's installation instructions. The indicated load-bearing capacity cannot be guaranteed and the manufacturer will not be liable for damages in the event of improper installation or the use of unauthorized mounting accessories. The system's load-bearing capacity cannot be guaranteed and the manufacturer will not be liable for damages in the event that loudspeakers, mounting accessories, and connecting and attaching components are modified in any way. Components affecting safety may only be repaired by the manufacturer or authorized agents, otherwise the operating permit will be voided.



Installation may be performed qualified personnel only, and then only at pick-points with sufficient load-carrying capacity and in compliance with local building regulations. Use only the mounting hardware specified by the manufacturer in the installation instructions (screws, anchors, etc.). Take all the precautions necessary to ensure bolted connections and other threaded locking devices will not loosen.



Fixed and portable installations (in this case, speakers and mounting accessories) must be secured by two independent safeties to prevent them from falling. Safeties must be able to catch accessories or parts that are loose or may become loose. Ensure compliance with the given national regulations when using connecting, attaching, and rigging devices. Factor potential dynamic forces (jerk) into the equation when determining the proper size and load-bearing capacity of safeties.



Be sure to observe speaker stands' maximum load-bearing capacity. Note that for reasons of design and construction, most speaker stands are approved to bear centric loads only; that is, the speakers' mass has to be precisely centered and balanced. Ensure speaker stands are set up stably and securely. Take appropriate added measures to secure speaker stands, for example when:

- the floor or ground surface does not provide a stable, secure base.
- they are extended to heights that impede stability.
- high wind pressure may be expected.
- there is the risk that they may be knocked over by people.

Special measures may become necessary as precautions against unsafe audience behavior. Do not set up speaker stands in evacuation routes and emergency exits. Ensure corridors are wide enough and put proper barriers and markings in place when setting speaker stands up in passageways. Mounting and dismounting are especially hazardous tasks. Use aids suitable for this purpose. Observe the given national regulations when doing so.



Wear proper protection (in particular, a helmet, gloves, and safety shoes) and use only suitable means of ascent (ladders, scaffolds, etc.) during installation. Compliance with this requirement is the sole responsibility of the company performing the installation.



WARNING! After installation, inspect the system comprised of the mounting fixtures and loudspeakers to ensure it is properly secured.

The operator of loudspeaker systems (fixed or portable) must regularly inspect or task a third party to regularly inspect all system components in accordance with the given country's regulations and have possible defects repaired immediately.

We also strongly recommend maintaining a logbook or the like to document all inspections.

Also be sure to provide sufficient safety margins for the rigging points used for flown systems. Observe the given national regulations when doing so.



Professional loudspeaker systems can produce harmful volume levels. Even prolonged exposure to seemingly harmless levels (starting at about 95 dBA SPL) can cause permanent hearing damage! Therefore we recommend that everyone who is exposed to high volume levels produced by loudspeaker systems wears professional hearing protection (earplugs or earmuffs).

Manufacturer: Stamer Musikanlagen GmbH, Magdeburger Str. 8, 66606 St. Wendel, Germany

LINEAR 9

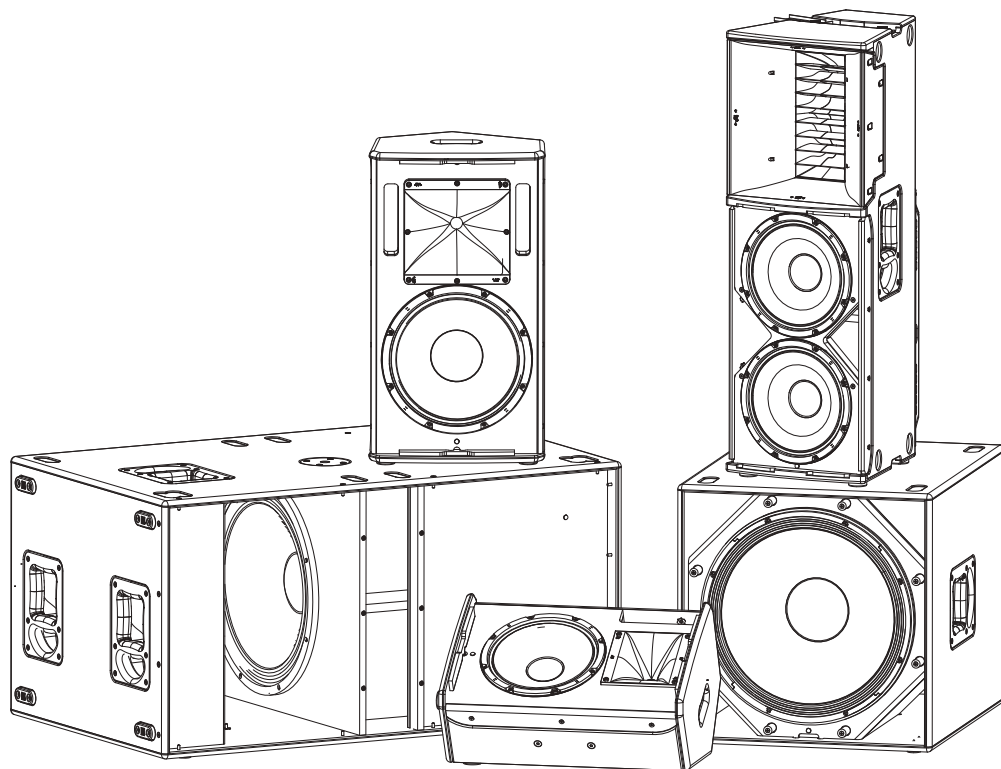

Welcome to the HK Audio family!

Thank you for choosing a brand-name product made by our company. Rest assured, we engineered and built it with the greatest care so it will serve you well for many tomorrows to come.



Even if your experience with sound systems runs deep, some things about this product are sure to be new to you. This is why we ask that you do not set this manual aside without reading it first. Be sure to keep it in a safe place for later reference.

Here's wishing you the best sound at every occasion!

Your HK Audio team



Strong electromagnetic interference or electrostatic discharge may prevent the product from functioning normally. If this happens, the product may be returned to normal operation by powering off and on again. Should this not result in the product functioning normally again, please move the product away from the source of disturbance and try again.

Warranty

Use the convenient online registration option at www.hkaudio.com.



<http://warranty.hkaudio.com>

The registration is only valid if the device is registered within 30 days of the date of purchase.

HK Audio

Technischer Service
Postfach 1509
66595 St. Wendel, Germany
Fax: +49 6851 905 100

1 General Information

Unpacking and Inventorying

When you first unpack your LINEAR 9 speaker cabinet, take a quick inventory to make sure it comes complete with the manual and Powercon mains cable.

2 Connectors and Controls

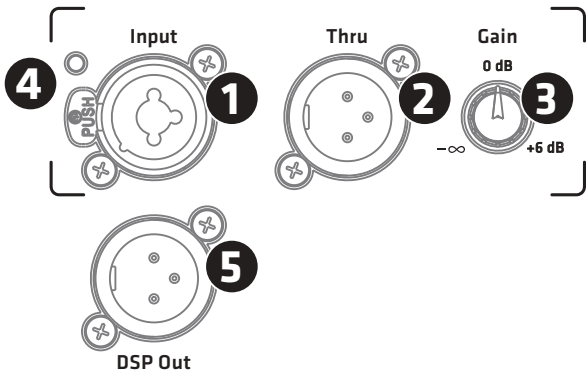

LINEAR 9 210 LTA • LINEAR 9 110 XA • LINEAR 9 112 XA

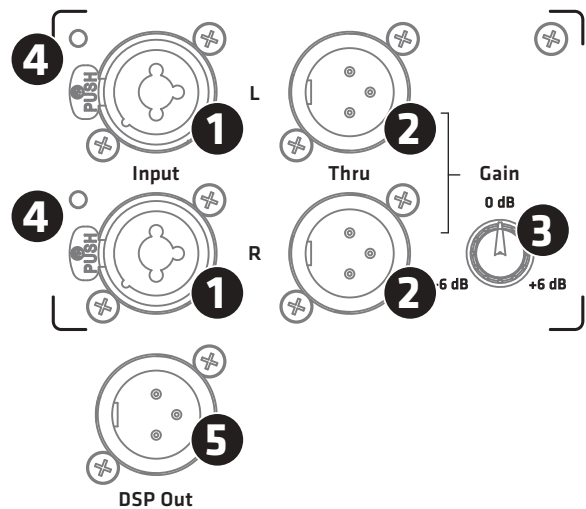

LINEAR 9 118 Sub A • LINEAR 9 118 Sub BA

1 Input

This XLR/ 1/4" (6.35 mm) combo jack provides a balanced input for analog signals.

- The mid/high units have one input channel.
- The two subwoofers have two inputs, one each for the left and right signals. The two channels are equal and merged post-preamp, so you can use either one in mono mode.

2 Thru

Use this parallel, balanced XLR output to send the signal routed into the Input through to other components. This output remains active even when the electronic components are deactivated. The subwoofer has two of these ports.

3 Gain

Use this knob to adjust the input gain for the incoming signal.

- The control range for the mid/high units sweeps from $-\infty$ (mute) to +6 dB.
- The preamp Gain control on each of the two subwoofers addresses both channels with a control range sweeping from -6 to +6 dB.

The center-notched 12 o'clock position is 0 dB in both cases.

Heads up: The Gain setting does not affect the signal sent to the DSP Out.

4 Input/Limiter LED

This LED lights up green to indicate incoming signals and red to indicate signal peaks. The LED briefly flashes red to tell you the Limiter is responding to signal peaks. If it stays red, turn down the Gain knob.

5 DSP Out

This balanced XLR port taps the analog signal routed in via the Input. You can use the internal DSP to process this signal. This way, the DSP Out can serve as a network interface that lets you integrate another non-network-enabled active speaker. In the factory default setup, the unprocessed input signal is routed to the DSP Out regardless of the selected preset and current position of the Gain knob.

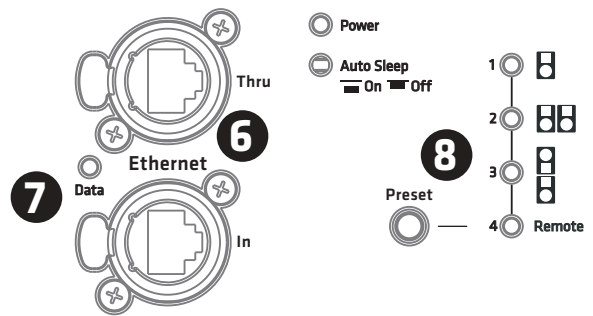

6 Ethernet In /Thru

Use the two Ethernet ports to integrate the speaker into a network. They accept RJ45 and Ethercon (NE8 MX, NE8 MX6, NE8 MC) plugs. Use the Ethernet Thru port to forward the network signal.

Always use S/STP or S/FTP cables to shield against electromagnetic interference. We recommend CAT6 cables. A separate manual explains how to integrate and remotely control speakers in a network. You'll find it posted on the LINEAR 9 downloads page at www.hkaudio.com. For a brief description of the DSP functions, see section 8 Preset.

7 Data

This LED lights up orange when data flows through the network connector.

8 Preset

Use the Preset selection button to call up factory presets or a user preset you can configure via the remote DSP CONTROL software. Tap the select button once to scroll through Presets 1 through 4.

A separate manual explains how to program the four remote user presets. You will find it on the LINEAR 9 download page at www.hkaudio.com.

A look at the presets:

	L9 210 LTA	L9 110 XA / L9 112 XA	L9 118 Sub A / L9 118 Sub BA
1	Stand Alone	Flat	Front
2	Cluster (2)	Monitor	Cardioid 1:1
3	Cluster (3)	Low Cut	Cardioid 2:1
4	Remote (to access stored settings via the remote HK Audio DSP CONTROL software)		

Factory presets: LINEAR 9 210 LTA

Stand Alone	for a single L9 210 LTA (per side)
Cluster (2)	for two connected L9 210 LTA units
Cluster (3)	for three connected L9 210 LTA units

Factory presets: LINEAR 9 110 XA • LINEAR 9 112 XA

Flat	Delivers linear response across the full frequency range
Monitor	Optimized to dampen the extra bass generated by floor coupling when you set a speaker on its side for use as a monitor
Low Cut	A high-pass filter optimizes the unit for use as a mid/high unit paired with the L9 118 Sub A/L9 118 Sub BA

Factory presets: LINEAR 9 118 Sub A • LINEAR 9 118 Sub BA

Front	Standard operating mode for a forward-facing subwoofer
Cardioid 1:1	For cardioid setups with one forward-facing L9 118 Sub A/ L9 118 Sub BA; see section 4.2 for more on this
Cardioid 2:1	For cardioid setups with two forward-facing L9 118 Sub A/ L9 118 Sub BA; see section 4.2 for more on this

Factory presets 1 to 3 address the speaker only and not the DSP Out.

Heads up: If you are operating the speaker in a network connected to the remote DSP CONTROL software, you can configure the DSP Out independently even when using factory presets 1 to 3. To learn more about this, consult the separate DSP CONTROL manual. You will find it on the LINEAR 9 download page at www.hkaudio.com.

The Remote Preset

Remote	This lets you call up a user preset that you previously stored via DSP CONTROL for the speaker as well as for the DSP Out. The speakers does not need to be connected to the remote software to do this.
--------	--

The remote preset's default setup is identical to factory preset 1 (Stand Alone/Flat/Front).

You can access the following DSP functions via the remote DSP CONTROL software and save your settings in user presets:

Fully parametric 10-band EQ with variable filter characteristics for each frequency band, high-pass and low-pass filters with variable filter characteristics, Limiter, Delay, Polarity, Level, and Mute

You can configure these parameters separately and independently for the speaker and its DSP Out.



Screenshot of the remote DSP CONTROL software. You can download this software free of charge at the LINEAR 9 product page at www.hkaudio.com. The speaker and DSP Out parameters are identical, but the powerful onboard DSP lets you configure each set independently.

9 Power

This rocker switch turns the power on and off. Set it to Power to turn the electronic components on and to Off to disconnect them from the mains power supply. The Power switch does not affect the Powercon Link port. See section 12 below for more on this.

10 Power-LED

This LED lights up green when the electronic components are getting mains power.

11 Mains Input

Use the factory-included Powercon mains cord to connect this socket to a power outlet. Insert the push-pull connector and turn it clockwise to make sure the Powercon cord engages and locks. To unlock it, pull the Powercon plug's locking mechanism towards the cable and turn it counterclockwise.

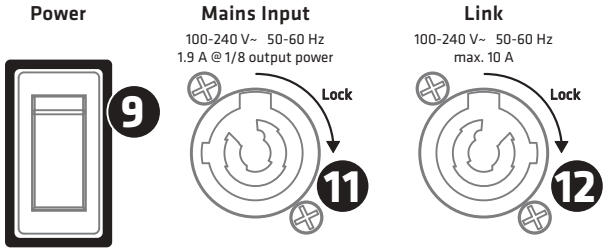
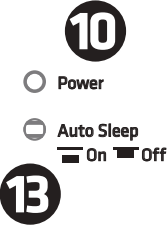

12 Link

This socket can power up to three additional LINEAR 9 speaker cabinets. Hardwired to the Mains Input, it is not affected by the Power switch setting. The Link circuit goes live the moment you connect the Mains Input to a power source. This is why you must make sure all downstream devices are switched off before you connect them to the Link port.

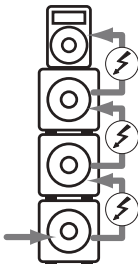

13 Auto Sleep

Use this recessed button to switch energy-saving Auto Sleep mode on and off. Your speaker leaves the factory with the Auto Sleep button pressed to enable this mode. This function puts the electronic components to sleep when four and a half hours pass without the speaker registering an audio signal, data sent to the Ethercon ports, or an adjustment of a button or knob. The only way to wake it up is by switching the Power button off and on again or patching an analog audio signal into the Input.

Heads up: You cannot wake up the speaker via the Ethercon ports.

There is but one way to deactivate the Auto Sleep function – by ‘unpressing’ the button to set it to the up position.

3 An Overview of the Various LINEAR 9 Models

The LINEAR 9 series consists of the LINEAR 9 210 LTA, LINEAR 9 110 XA and LINEAR 9 112 XA mid/high units and the two LINEAR 9 118 Sub A and LINEAR 9 118 Sub BA subwoofers. The housings of the multifunctional LINEAR 9 110 XA and LINEAR 9 112 XA models are angled 30° so you can also set them sideways for use monitors. The LINEAR 9 210 LTA cabinet is shaped to enable you to quickly and easily set up clusters.

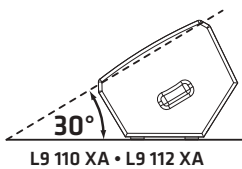

All mid/high units are loaded with rotatable horns. The directivity of each cabinet's horn is optimized for its primary purpose – that is, the most frequently used application. You need tools to rotate the horns, so they are not conducive to frequent adjustment. The idea is to optimize the throw pattern for the cabinet's primary application.

- The LINEAR 9 210 LTA MCT horn's horizontal directivity is 60° for stand-alone applications. If you deploy the LINEAR 9 210 LTA in a cluster, be sure to rotate the horn so it has a horizontal directivity of 25°.
- The LINEAR 9 110 XA cab sports a 10" woofer and a horn with a wide 80°x60° throw pattern to provide uniform near-field coverage. LINEAR 9 112 XA features a 12" woofer and a horn with a medium 70°x50° throw pattern.

Tip: You do not have to rotate the horn when setting the XA cabs on its side for use as a stage monitor. In fact, the upright speaker's narrower vertical throw pattern works great in the horizontal position. Its tightly focused directivity minimizes overlap with adjacent monitors and reduces the risk of feedback risk because you can aim the speaker more accurately.

4 Setting Up Speakers

4.1 The mid/high units

LINEAR 9 mid/high units may be stacked on subwoofers, mounted on speaker stands or poles, installed with wall brackets, or flown with the proper rigging hardware. All Mid/High models have a DuoTilt 3°/7° flange.

• Placing Speakers on Stands and Poles

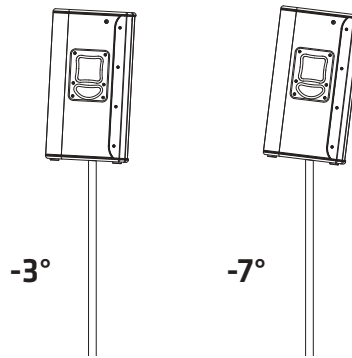

The all Mid/High units are equipped with the HK Audio DuoTilt 3°/7°, a special type of pole mount for 35-mm speaker stands and poles that provides tilt angles of -3° and -7°.

General Info about Setting Up with Speaker Stands

Heads-up: Always make sure the speaker stand is on solid footing and be sure to observe the manufacturer's instructions as to its maximum load-bearing capacity.



- Use only speaker stands that are stable enough to prevent accidental tipping. Ensure the speaker stand is designed to handle the cabinet's weight. Adjustable stands' highest setting must be limited to prevent the combination of speaker stand and speaker from tipping. This applies when setting the stand on a flat, horizontal surface.
- When setting up on an uneven or sloping surface, make sure the speaker stand's base is secured to prevent accidental tipping, either by attaching suitable weights to the base or taking other measures to secure the stand.
- The use of any other fixtures or fittings can result in instability that may result in injury.

• Setting Up with the Tilt Unit

HK Audio offers the Tilt Unit as an optional accessory to secure speakers stacked on subwoofers. It screws into the M20 mount on the LINEAR 9 118 Sub A/LINEAR 9 118 Sub BA like a speaker pole to prevent the top units from moving. The two -3° and -7° tilt positions of the DuoTilt on the Mid/High units can also serve to secure the stacked speaker.

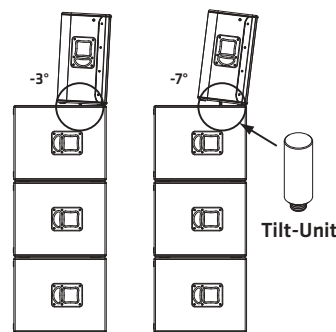

Heads up! When you stack speakers without using the Tilt Unit to fix them in place, be sure to secure the mid/high units – for example, with a lashing strap to hold them in place.

• Rigging

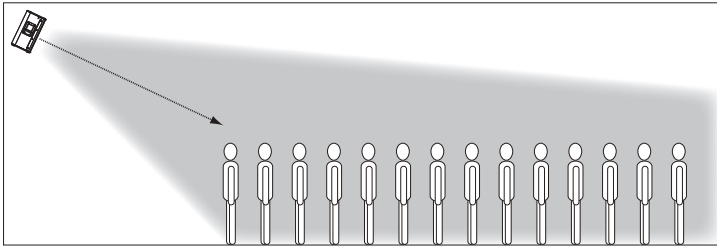

You can fly the XA models either from their built-in rigging points using steel cables or chains and the AP-8 attachment or using the appropriate rigging harness. They have specially reinforced rigging points with 2x8 mm threads designed to accept the optionally available HK Audio TB-28N tilt bracket.

The LINEAR 9 210 LTA can be flown using the optionally available TB-210NQ. It bolts into the MultiGrip handles. See the mounting instructions included with the brackets for more on this.

• Clustering the LINEAR 9 210 LTA

The LINEAR 9 210 LTA has built-in, fast-mount hardware that makes it easy to cluster two or more units.

When stacking speakers, place LINEAR 9 210 LTA units on the subwoofers with their side panels touching. The rubber bumpers on one cabinet fit into indentations in the neighboring wood cabinet to properly align the two speakers on the horizontal plane. Fix the preconfigured cluster in place by screwing down the top cluster couplers to connect the neighboring speakers:

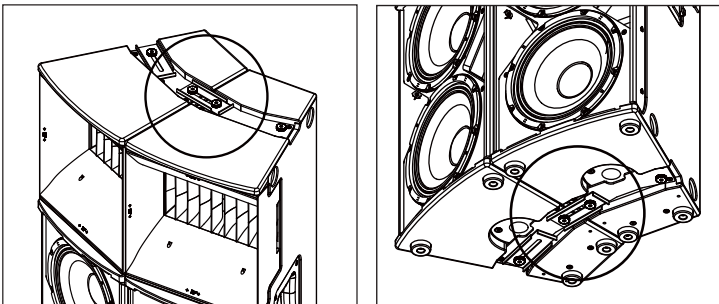

You can also fly one LINEAR 9 210 LTA or a cluster of two with the optional TB-210NQ tilt bracket. If you want to fly two speakers with this tilt bracket, you have to additionally secure the cluster with the bottom cluster couplers. This is mandatory.

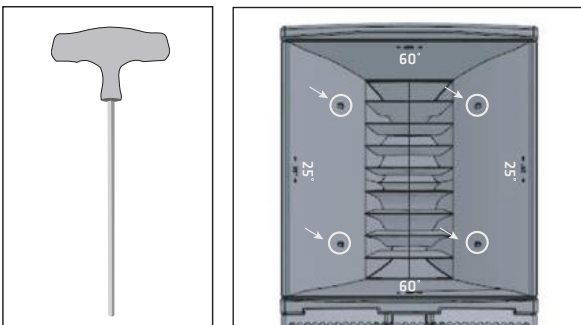

To get the best audio results when clustering LINEAR 9 210 LTAs, you will have to rotate the two adjacent horns to set them to a horizontal directivity of 25°. The angles are clearly marked on the horns.

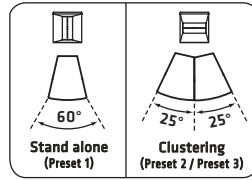

Select the appropriate preset on the back of the speakers for the given type of cluster.

4.2 LINEAR 9 118 Sub A / LINEAR 9 118 Sub BA

Deploy the LINEAR 9 118 Sub A as you would any other direct radiating subwoofer. However, do not stack the bass bins when configuring cardioid setups. Instead, place them side by side, maintaining a distance of at least one meter from walls.

Do not stack LINEAR 9 118 Sub BA subwoofers in cardioid setups. Instead, place them upright and array them side by side. Maintain a distance of at least one meter from walls for both cardioid setups.

You have two cardioid setups to choose from – Cardioid 1:1 and Cardioid 2:1.

A control on the back of the two subwoofers serves to select the appropriate preset. See section 2, 8 Preset, for more on this:

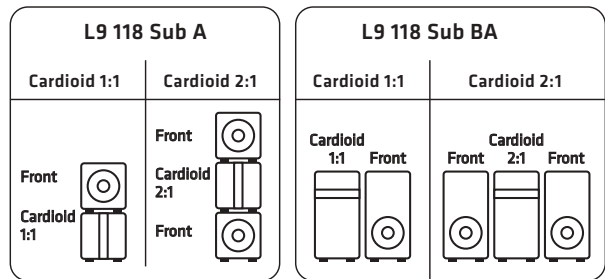

Both setups attenuate the rearward sound pressure level by up to 34 dB, and boost the forward SPL around 2 dB.

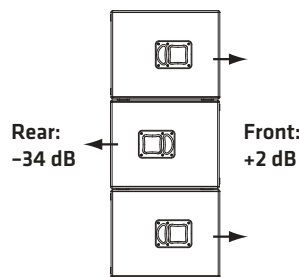

When is it a good idea to go with a cardioid setup?

While speakers are able to throw midrange and high frequencies in directional patterns, low frequencies tend to radiate in all directions. Excessive bass levels can often be a problem on and behind the stage. And promoters are increasingly making demands to limit sound systems' low-end reach, for example, in festival tents at urban venues. Such demands for limiting low-range frequencies' range are best met with cardioid setups. With their hardware appointments and filter sets, the two LINEAR 9 series subwoofers provide a fast, easy way of configuring effective cardioid setups.

5 Example Systems

5.1 Setting Up a 2.1 Stereo System

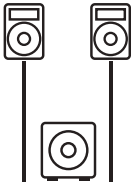

With the benefit of the LINEAR 9 118 Sub A's onboard stereo preamp, you can easily set up a 2.1 system routing both the left and right channels into the LINEAR 9 118 Sub A and then forwarding their signals to the mid/high units via its two Thru ports. The LINEAR 9 110 XA's wide throw patterns are perfect for this application.

Presets:

Mid/high units	Low Cut
L9 118 Sub A	Front

For a balanced image, center the subwoofer between the two mid/high units.

5.2 Setting Speakers on Poles

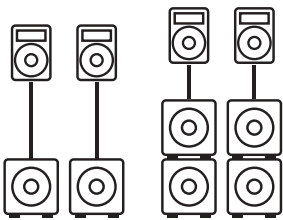

If you wish to place mid/high units on speaker poles rather than stands, simply screw a pole with an M20 thread into the M20 pole mount on the LINEAR 9 118 Sub A.

Presets:

Mid/high units	Low Cut
L9 118 Sub A	Front

5.3 Stacking Speakers

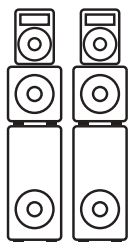

Placing one LINEAR 9 118 Sub A on top of an upright LINEAR 9 118 Sub BA creates a 1.65 m stack. In this case, you may place the mid/ high units directly on the bass bins.

Presets:

Mid/high units	Low Cut
L9 118 Sub A	Front
L9 118 Sub BA	Front

5.4 Configuring a 1:1 Cardioid Setup

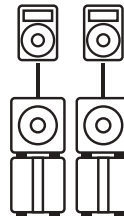

Use a speaker pole to set up 1:1 cardioid systems. Aim the bottom subwoofers to the rear.

Presets:

Mid/high units	Low Cut
L9 118 Sub A - top	Front
L9 118 Sub A - bottom	Cardioid 1:1

5.5 Configuring a 2:1 Cardioid Setup

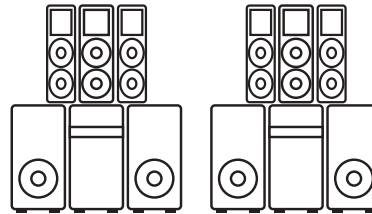

When setting up full cardioid stacks, aim the middle subwoofers to the rear.

Presets:

L9 210 LTA	Cluster (3)
L9 118 Sub BA - left	Front
L9 118 Sub BA - center	Cardioid 2:1
L9 118 Sub BA - right	Front

6 Optional HK Audio Accessories

HK Audio offers covers for all mid/high units and a case for the LINEAR 9 210 LTA BA to protect them in transit as well as tilt brackets for mounting and flying the speaker cabinets. A control panel cover (RPP) is available for the LINEAR 9 210 LTA to protect electronic components from rain outdoors.

HK Audio also offers covers for the LINEAR 9 118 Sub A and the LINEAR 9 118 Sub BA as well as two versions of a robust control panel cover (RPP) to splash-proof the electronic components and to guard against unauthorized handling in cardioid mode. Both types of subwoofers have mounting points for wheels

Learn more about LINEAR 9 accessories on the LINEAR 9 product pages at www.hkaudio.com.

7 Technical Specifications

Model	LINEAR 9 210 LTA	LINEAR 9 110 XA	LINEAR 9 112 XA	LINEAR 9 118 SUB A	LINEAR 9 118 SUB BA
Max. SPL @ 10% THD	133 dB half space * (88 Hz - 12 kHz averaged)	126 dB half space (70 Hz - 12 kHz averaged)	128 dB half space (70 Hz - 12 kHz averaged)	129 dB half space (42 Hz - 100 Hz averaged)	134 dB half space (40 Hz - 110 Hz averaged)
Max. SPL peak @ 10% THD	142 dB half space *	129 dB half space	131 dB half space	131 dB half space	136 dB half space
Frequency response +/- 3 dB	105 Hz - 19 kHz (high pass filter with 24 dB/oct. at 100 Hz)	70 Hz - 19 kHz	67 Hz - 19 kHz	42 Hz - X-over	38 Hz - X-over
Frequency response -10 dB	84 Hz - 20 kHz (high pass filter with 24 dB/oct. at 100 Hz)	65 Hz - 20 kHz	62 Hz - 20 kHz	38 Hz - X-over	31 Hz - X-over
Power amp output (RMS)	1,000 W	700 W	700 W	1,100 W	1,100 W
Amp type	Class D - biamped	Class D - biamped	Class D - biamped	Class D	Class D
LF driver	-	-	-	1x 18", 4" voice coil	1x 18", 4" voice coil
Low-/mid speaker	2x 10", 2.5" voice coil	1x 10", 2.5" voice coil	1x 12", 2.5" voice coil	-	-
HF driver	1.4", 2.5" voice coil	1", 1.4" voice coil	1", 1.7" voice coil	-	-
Horn directivity	60° x 25° MCT horn, rotatable	80° x 60° CD horn, rotatable	70° x 50° CD horn, rotatable	-	-
Active crossover frequency	1.35 kHz FIR X-over with 72 db/ oct.	2 kHz FIR X-Over with 60 dB/oct.	1.6 kHz FIR X-Over with 60 dB/oct.	-	-
Maximum input level	+20 dBu	+20 dBu	+20 dBu	+20 dBu	+20 dBu
Analog inputs	1x XLR combo balanced	1x XLR combo balanced	1x XLR combo balanced	2x XLR combo balanced	2x XLR combo balanced
Analog thru	1x XLR balanced	1x XLR balanced	1x XLR balanced	2x XLR balanced	2x XLR balanced
DSP Out	1x XLR balanced	1x XLR balanced	1x XLR balanced	1x XLR balanced	1x XLR balanced
Network port	Ethercon RJ45, 1x In, 1x Thru	Ethercon RJ45, 1x In, 1x Thru	Ethercon RJ45, 1x In, 1x Thru	Ethercon RJ45, 1x In, 1x Thru	Ethercon RJ45, 1x In, 1x Thru
Filter presets	Stand Alone, Cluster (2), Cluster (3), Remote	Flat, Monitor, Low Cut, Remote	Flat, Monitor, Low Cut, Remote	Front, Cardioid 1:1, Cardioid 2:1, Remote	Front, Cardioid 1:1, Cardioid 2:1, Remote
Remote software	DSP CONTROL (Windows, macOS)	DSP CONTROL (Windows, macOS)	DSP CONTROL (Windows, macOS)	DSP CONTROL (Windows, macOS)	DSP CONTROL (Windows, macOS)
DSP functions	Fully parametric 10-band EQ with variable filter characteristics, High-Pass Filter, Low-Pass Filter, Polarity, Level, Delay, Limiter, Mute	Fully parametric 10-band EQ with variable filter characteris- tics, High-Pass Filter, Low-Pass Filter, Polarity, Level, Delay, Limiter, Mute	Fully parametric 10-band EQ with variable filter characteris- tics, High-Pass Filter, Low-Pass Filter, Polarity, Level, Delay, Limiter, Mute	Fully parametric 10-band EQ with variable filter characteristics, High-Pass Filter, Low-Pass Filter, Polarity, Level, Delay, Limiter, Mute	Fully parametric 10-band EQ with variable filter characteristics, High-Pass Filter, Low-Pass Filter, Polarity, Level, Delay, Limiter, Mute
Sampling rate	96 kHz	96 kHz	96 kHz	96 kHz	96 kHz
System latency	less than 2.9 ms	less than 2.6 ms	less than 2.6 ms	less than 2.6 ms	less than 2.6 ms
Mains connector	1x Powercon NAC3 In, 1x Powercon NAC3 Thru, 100-240 V	1x Powercon NAC3 In, 1x Powercon NAC3 Thru, 100-240 V	1x Powercon NAC3 In, 1x Powercon NAC3 Thru, 100-240 V	1x Powercon NAC3 In, 1x Powercon NAC3 Thru, 100-240 V	1x Powercon NAC3 In, 1x Powercon NAC3 Thru, 100-240 V
Power consumption	2.5 A / 100-240 V nominal according to EN 62368-1	1 A / 100-240 V nominal according to EN 62368-1	1 A / 100-240 V nominal according to EN 62368-1	1.9 A / 100-240 V nominal according to EN 62368-1	1.9 A / 100-240 V nominal according to EN 62368-1
Clustering angle	25°	-	-	-	-
Angles up (Monitor angle)	-	30°	30°	-	-
Pole mount	DuoTilt 3°/7°	DuoTilt 3°/7°	DuoTilt 3°/7°	1x M20	2x M20
Rigging points	-	5x M8 (AP-8)	5x M8 (AP-8)	-	-
Carrying handles	2x MultiGrip	2x SingleGrip	1x SingleGrip, 1x MultiGrip	2x MultiGrip	8x MultiGrip
Housing	Birch multiplex	Birch multiplex	Birch multiplex	Birch multiplex	Birch multiplex
Finish	PU coating black	PU coating black	PU coating black	PU coating black	PU coating black
Front grille	2 mm metal grille backed with black acoustic foam	2 mm metal grille backed with black acoustic foam	2 mm metal grille backed with black acoustic foam	2 mm metal grille backed with black acoustic foam	2 mm metal grille backed with black acoustic foam
Dimensions (WxHxD)	34 x 96 x 39 cm 13-25/64 x 37-3/4 x 15-23/64"	36 x 54 x 31 cm 14-11/64 x 21-1/4 x 12-13/64"	37 x 67 x 31 cm 14-9/16 x 26-3/8 x 12-13/64"	55 x 56 x 69 cm 21-21/32 x 22-3/64 x 27-11/64"	111 x 56 x 69 cm 43-9/32 x 22-3/64 x 27-11/64"
Weight	33 kg / 72.8 lbs	16.5 kg / 36.4 lbs	20.5 kg / 45.2 lbs	41.5 kg / 91.5 lbs	63.5 kg / 139.9 lbs

(* = Preliminary data)

LINEAR 9



HK Audio® • Postfach 1509 • 66595 St. Wendel • Germany • info@hkaudio.com • www.hkaudio.com
International Inquiries: fax +49-68 51-905 215 • international@hkaudio.com

Subject to change without notice • Technische Änderungen vorbehalten
Copyrights 2021 Music & Sales GmbH • 11/2021