

DENON

DJ MIXER

DN-X1500

OPERATING INSTRUCTIONS

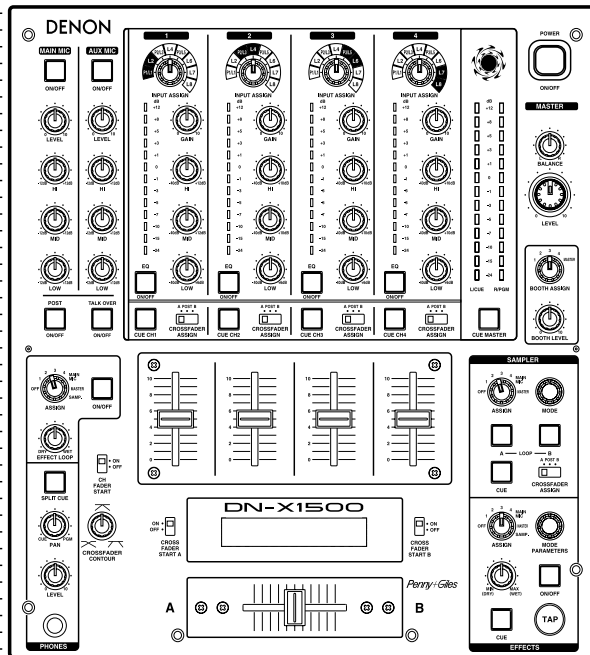



CAUTION
RISK OF ELECTRIC SHOCK
DO NOT OPEN



CAUTION: TO REDUCE THE RISK OF ELECTRIC SHOCK, DO NOT REMOVE COVER (OR BACK). NO USER SERVICEABLE PARTS INSIDE. REFER SERVICING TO QUALIFIED SERVICE PERSONNEL.



The lightning flash with arrowhead symbol, within an equilateral triangle, is intended to alert the user to the presence of uninsulated "dangerous voltage" within the product's enclosure that may be of sufficient magnitude to constitute a risk of electric shock to persons.



The exclamation point within an equilateral triangle is intended to alert the user to the presence of important operating and maintenance (servicing) instructions in the literature accompanying the appliance.

WARNING: TO PREVENT FIRE OR SHOCK HAZARD, DO NOT EXPOSE THIS APPLIANCE TO RAIN OR MOISTURE.

CAUTION:

1. Handle the power supply cord carefully

Do not damage or deform the power supply cord. If it is damaged or deformed, it may cause electric shock or malfunction when used. When removing from wall outlet, be sure to remove by holding the plug attachment and not by pulling the cord.

2. Do not open the top cover

In order to prevent electric shock, do not open the top cover.
If problems occur, contact your DENON dealer.

3. Do not place anything inside

Do not place metal objects or spill liquid inside the DJ mixer.
Electric shock or malfunction may result.

Please, record and retain the Model name and serial number of your set shown on the rating label.

Model No. DN-X1500 Serial No. _____

LABELS:

This device complies with Part 15 of the FCC Rules. Operation is subject to the following two conditions: (1) This device may not cause harmful interference, and (2) this device must accept any interference received, including interference that may cause undesired operation.

This Class B digital apparatus meets all requirements of the Canadian Interference-Causing Equipment Regulations.

Cet appareil numérique de la classe B respecte toutes les exigences du Règlement sur le matériel brouilleur du Canada.

CAUTION

TO PREVENT ELECTRIC SHOCK, MATCH WIDE BLADE OF PLUG TO WIDE SLOT, FULLY INSERT.

SAFETY INSTRUCTIONS

1. Read Instructions – All the safety and operating instructions should be read before the product is operated.
2. Retain Instructions – The safety and operating instructions should be retained for future reference.
3. Heed Warnings – All warnings on the product and in the operating instructions should be adhered to.
4. Follow Instructions – All operating and use instructions should be followed.
5. Cleaning – Unplug this product from the wall outlet before cleaning. Do not use liquid cleaners or aerosol cleaners.
6. Attachments – Do not use attachments not recommended by the product manufacturer as they may cause hazards.
7. Water and Moisture – Do not use this product near water – for example, near a bath tub, wash bowl, kitchen sink, or laundry tub; in a wet basement; or near a swimming pool; and the like.
8. Accessories – Do not place this product on an unstable cart, stand, tripod, bracket, or table. The product may fall, causing serious injury to a child or adult, and serious damage to the product. Use only with a cart, stand, tripod, bracket, or table recommended by the manufacturer, or sold with the product. Any mounting of the product should follow the manufacturer's instructions, and should use a mounting accessory recommended by the manufacturer.
9. A product and cart combination should be moved with care. Quick stops, excessive force, and uneven surfaces may cause the product and cart combination to overturn.
10. Ventilation – Slots and openings in the cabinet are provided for ventilation and to ensure reliable operation of the product and to protect it from overheating, and these openings must not be blocked or covered. The openings should never be blocked by placing the product on a bed, sofa, rug, or other similar surface. This product should not be placed in a built-in installation such as a bookcase or rack unless proper ventilation is provided or the manufacturer's instructions have been adhered to.
11. Power Sources – This product should be operated only from the type of power source indicated on the marking label. If you are not sure of the type of power supply to your home, consult your product dealer or local power company. For products intended to operate from battery power, or other sources, refer to the operating instructions.
12. Grounding or Polarization – This product may be equipped with a polarized alternating-current line plug (a plug having one blade wider than the other). This plug will fit into the power outlet only one way. This is a safety feature. If you are unable to insert the plug fully into the outlet, try reversing the plug. If the plug should still fail to fit, contact your electrician to replace your obsolete outlet. Do not defeat the safety purpose of the polarized plug.
13. Power-Cord Protection – Power-supply cords should be routed so that they are not likely to be walked on or pinched by items placed upon or against them, paying particular attention to cords at plugs, convenience receptacles, and the point where they exit from the product.
15. Outdoor Antenna Grounding – If an outside antenna or cable system is connected to the product, be sure the antenna or cable system is grounded so as to provide some protection against voltage surges and built-up static charges. Article 810 of the National Electrical Code, ANSI/NFPA 70, provides information with regard to proper grounding of the mast and supporting structure, grounding of the lead-in wire to an antenna discharge unit, size of grounding conductors, location of antenna-discharge unit, connection to grounding electrodes, and requirements for the grounding electrode. See Figure A.
16. Lightning – For added protection for this product during a lightning storm, or when it is left unattended and unused for long periods of time, unplug it from the wall outlet and disconnect the antenna or cable system. This will prevent damage to the product due to lightning and power-line surges.
17. Power Lines – An outside antenna system should not be located in the vicinity of overhead power lines or other electric light or power circuits, or where it can fall into such power lines or circuits. When installing an outside antenna system, extreme care should be taken to keep from touching such power lines or circuits as contact with them might be fatal.
18. Overloading – Do not overload wall outlets, extension cords, or integral convenience receptacles as this can result in a risk of fire or electric shock.
19. Object and Liquid Entry – Never push objects of any kind into this product through openings as they may touch dangerous voltage points or short-out parts that could result in a fire or electric shock. Never spill liquid of any kind on the product.
20. Servicing – Do not attempt to service this product yourself as opening or removing covers may expose you to dangerous voltage or other hazards. Refer all servicing to qualified service personnel.
21. Damage Requiring Service – Unplug this product from the wall outlet and refer servicing to qualified service personnel under the following conditions:
 - a) When the power-supply cord or plug is damaged,
 - b) If liquid has been spilled, or objects have fallen into the product,
 - c) If the product has been exposed to rain or water,
 - d) If the product does not operate normally by following the operating instructions. Adjust only those controls that are covered by the operating instructions as an improper adjustment of other controls may result in damage and will often require extensive work by a qualified technician to restore the product to its normal operation,
 - e) If the product has been dropped or damaged in any way, and
 - f) When the product exhibits a distinct change in performance – this indicates a need for service.

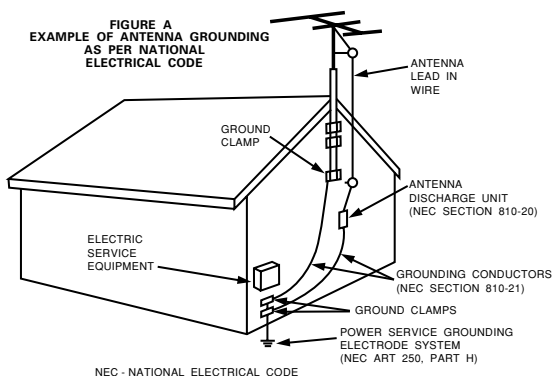

22. Replacement Parts – When replacement parts are required, be sure the service technician has used replacement parts specified by the manufacturer or have the same characteristics as the original part. Unauthorized substitutions may result in fire, electric shock, or other hazards.
23. Safety Check – Upon completion of any service or repairs to this product, ask the service technician to perform safety checks to determine that the product is in proper operating condition.
24. Wall or Ceiling Mounting – The product should be mounted to a wall or ceiling only as recommended by the manufacturer.
25. Heat – The product should be situated away from heat sources such as radiators, heat registers, stoves, or other products (including amplifiers) that produce heat.

TOP PANEL DIAGRAM

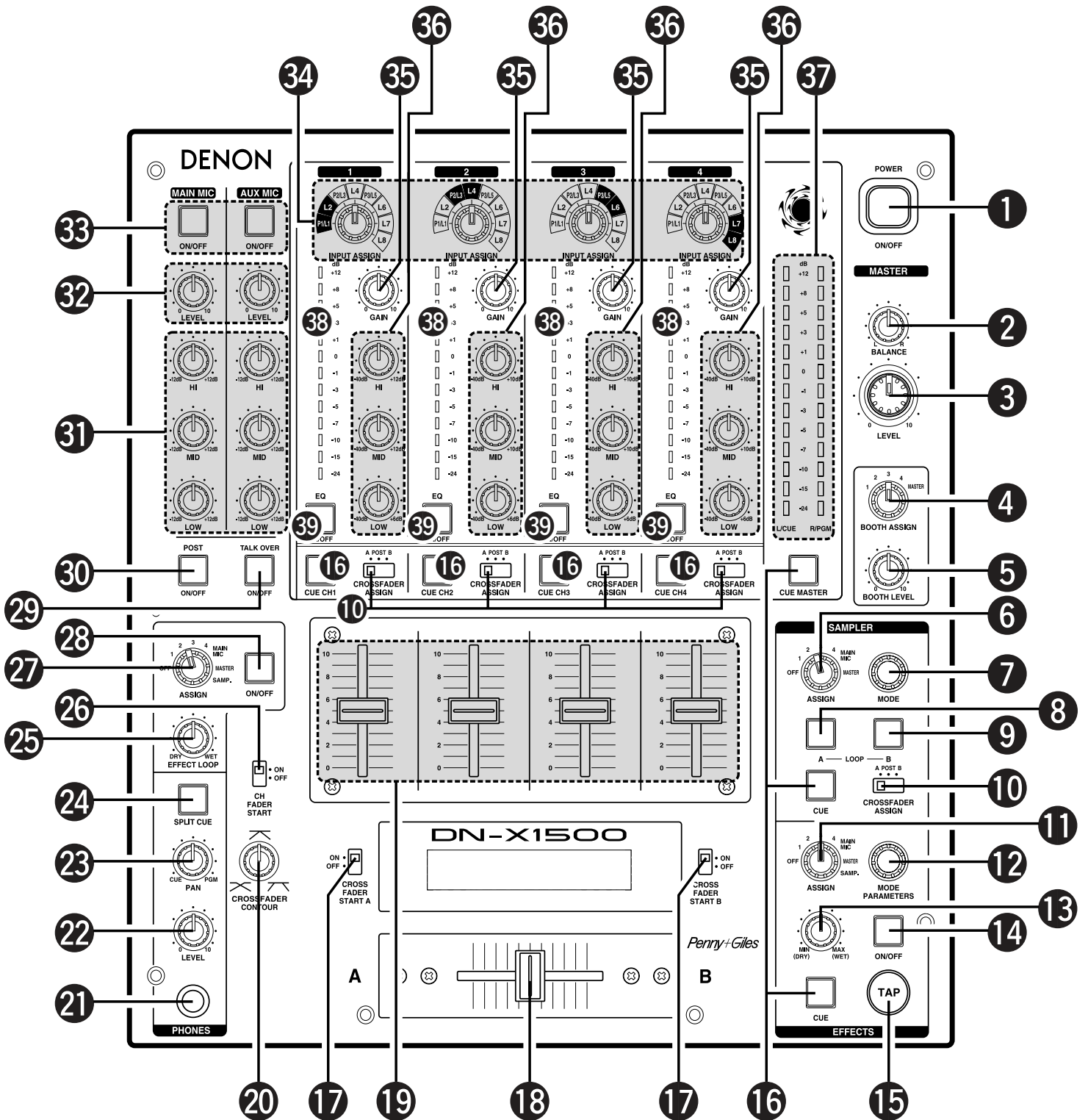

REAR PANEL DIAGRAM

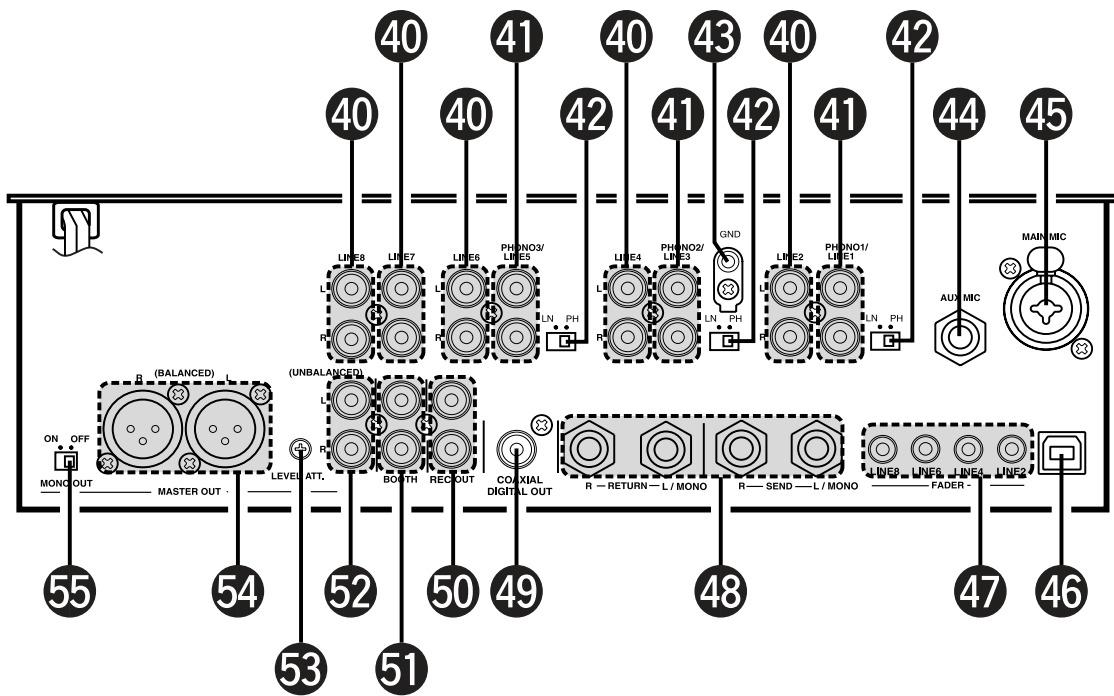

DISPLAY

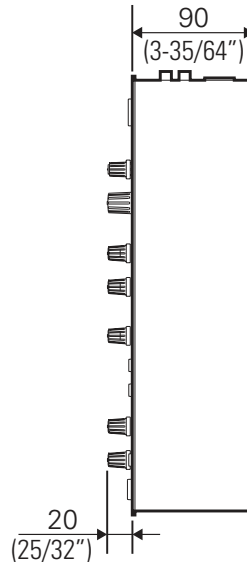
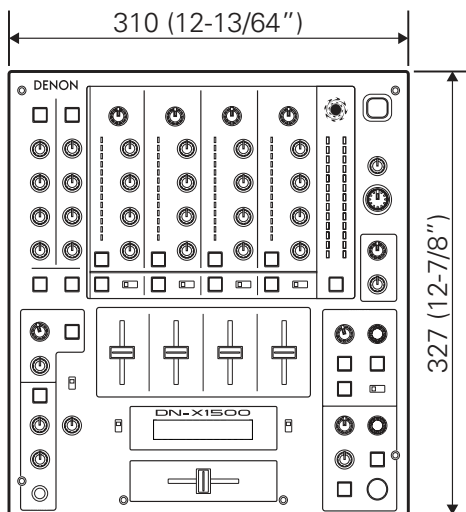
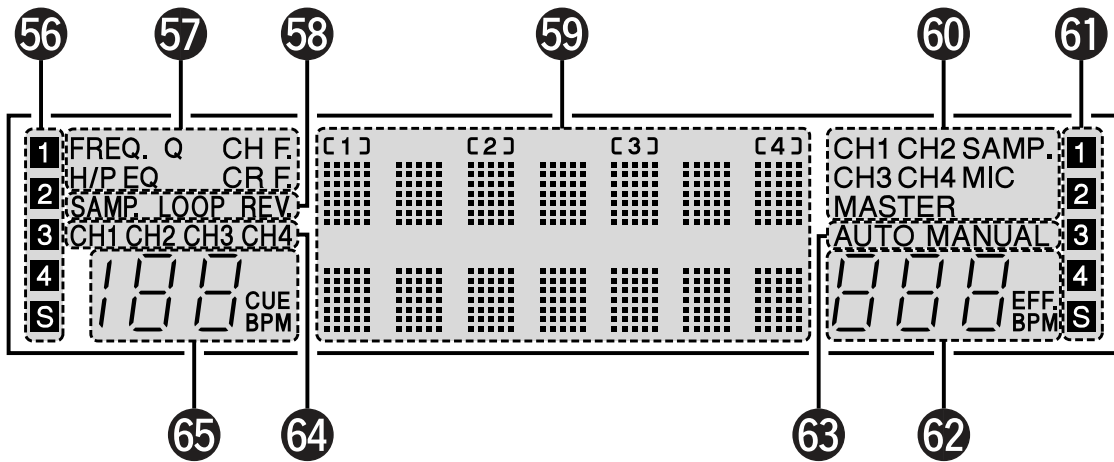

Unit: mm

NOTE ON USE / OBSERVATIONS RELATIVES A L'UTILISATION

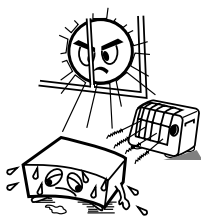

- Avoid high temperatures. Allow for sufficient heat dispersion when installed on a rack.
- Vermeiden Sie hohe Temperaturen. Beachten Sie, daß eine ausreichend Luftzirkulation gewährleistet wird, wenn das Gerät auf ein Regal gestellt wird.
- Eviter des températures élevées. Tenir compte d'une dispersion de chaleur suffisante lors de l'installation sur une étagère.
- Evitate di esporre l'unità a temperature alte. Assicuratevi che ci sia un'adeguata dispersione del calore quando installate l'unità in un mobile per componenti audio.
- Evite altas temperaturas. Permite la suficiente dispersión del calor cuando está instalado en la consola.
- Vermijd hoge temperaturen. Zorg voor een degelijk hitteafvoer indien het apparaat op een rek wordt geplaatst.
- Undvik höga temperaturer. Se till att det finns möjlighet till god värmeavledning vid montering i ett rack.

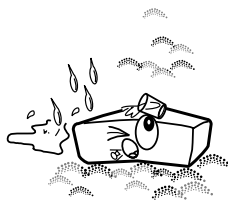

- Keep the set free from moisture, water, and dust.
- Halten Sie das Gerät von Feuchtigkeit, Wasser und Staub fern.
- Protéger l'appareil contre l'humidité, l'eau et la poussière.
- Tenete l'unità lontana dall'umidità, dall'acqua e dalla polvere.
- Mantenga el equipo libre de humedad, agua y polvo.
- Laat geen vochtigheid, water of stof in het apparaat binnendringen.
- Utsätt inte apparaten för fukt, vatten och damm.

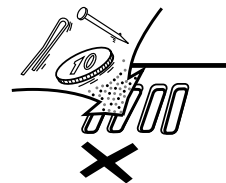

- Do not let foreign objects in the set.
- Keine fremden Gegenstände in das Gerät kommen lassen.
- Ne pas laisser des objets étrangers dans l'appareil.
- E' importante che nessun oggetto è inserito all'interno dell'unità.
- No deje objetos extraños dentro del equipo.
- Laat geen vreemde voorwerpen in dit apparaat vallen.
- Se till att främmande föremål inte tränger in i apparaten.

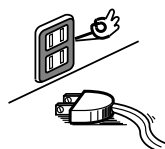

- Unplug the power cord when not using the set for long periods of time.
- Wenn das Gerät eine längere Zeit nicht verwendet werden soll, trennen Sie das Netzkabel vom Netzstecker.
- Débrancher le cordon d'alimentation lorsque l'appareil n'est pas utilisé pendant de longues périodes.
- Disinnestate il filo di alimentazione quando avete l'intenzione di non usare il filo di alimentazione per un lungo periodo di tempo.
- Desconecte el cordón de energía cuando no utilice el equipo por mucho tiempo.
- Neem altijd het netsnoer uit het stopcontact wanneer het apparaat gedurende een lange periode niet wordt gebruikt.
- Koppla ur nätkabeln om apparaten inte kommer att användas i lång tid.

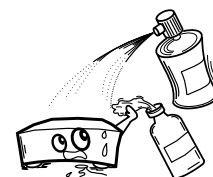

- Do not let insecticides, benzene, and thinner come in contact with the set.
- Lassen Sie das Gerät nicht mit Insektiziden, Benzin oder Verdünnungsmitteln in Berührung kommen.
- Ne pas mettre en contact des insecticides, du benzène et un diluant avec l'appareil.
- Assicuratevi che l'unità non venga in contatto con insetticidi, benzolo o solventi.
- No permita el contacto de insecticidas, gasolina y diluyentes con el equipo.
- Laat geen insektenverdelgende middelen, benzine of verfverdunder met dit apparaat in contact komen.
- Se till att inte insektsmedel på spraybruk, bensen och thinner kommer i kontakt med apparatens hölje.



- Handle the power cord carefully. Hold the plug when unplugging the cord.
- Gehen Sie vorsichtig mit dem Netzkabel um. Halten Sie das Kabel am Stecker, wenn Sie den Stecker herausziehen.
- Manipuler le cordon d'alimentation avec précaution. Tenir la prise lors du débranchement du cordon.
- Manneggiare il filo di alimentazione con cura. Agite per la spina quando scollegate il cavo dalla presa.
- Maneje el cordón de energía con cuidado. Sostenga el enchufe cuando desconecte el cordón de energía.
- Hanteer het netsnoer voorzichtig. Houd het snoer bij de stekker vast wanneer deze moet worden aan- of losgekoppeld.
- Hantera nätkabeln varsamt. Håll i kabeln när den kopplas från el-uttaget.

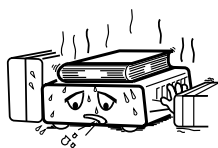

* (For sets with ventilation holes)

- Do not obstruct the ventilation holes.
- Die Belüftungsöffnungen dürfen nicht verdeckt werden.
- Ne pas obstruer les trous d'aération.
- Non coprite i fori di ventilazione.
- No obstruya los orificios de ventilación.
- De ventilatieopeningen mogen niet worden geblokkeerd.
- Täpp inte till ventilationsöppningarna.

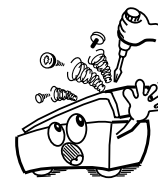

- Never disassemble or modify the set in any way.
- Versuchen Sie niemals das Gerät auseinander zu nehmen oder auf jegliche Art zu verändern.
- Ne jamais démonter ou modifier l'appareil d'une manière ou d'une autre.
- Non smontate mai, nè modificate l'unità in nessun modo.
- Nunca desarme o modifique el equipo de ninguna manera.
- Nooit dit apparaat demonteren of op andere wijze modificeren.
- Ta inte isär apparaten och försök inte bygga om den.

CAUTION

- The ventilation should not be impeded by covering the ventilation openings with items, such as newspapers, table-cloths, curtains, etc.
- No naked flame sources, such as lighted candles, should be placed on the apparatus.

- Please be care the environmental aspects of battery disposal.
- The apparatus shall not be exposed to dripping or splashing for use.
- No objects filled with liquids, such as vases, shall be placed on the apparatus.

• **DECLARATION OF CONFORMITY**

We declare under our sole responsibility that this product, to which this declaration relates, is in conformity with the following standards: EN60065, EN55013, EN55020, EN61000-3-2 and EN61000-3-3.

Following the provisions of 73/23/EEC, 89/336/EEC and 93/68/EEC Directive.

• **ÜBEREINSTIMMUNGSERKLÄRUNG**

Wir erklären unter unserer Verantwortung, daß dieses Produkt, auf das sich diese Erklärung bezieht, den folgenden Standards entspricht:

EN60065, EN55013, EN55020, EN61000-3-2 und EN61000-3-3.

Entspricht den Verordnungen der Direktive 73/23/EEC, 89/336/EEC und 93/68/EEC.

• **DECLARATION DE CONFORMITE**

Nous déclarons sous notre seule responsabilité que l'appareil, auquel se réfère cette déclaration, est conforme aux standards suivants:

EN60065, EN55013, EN55020, EN61000-3-2 et EN61000-3-3.

D'après les dispositions de la Directive 73/23/EEC, 89/336/EEC et 93/68/EEC.

• **DICHIARAZIONE DI CONFORMITÀ**

Dichiariamo con piena responsabilità che questo prodotto, al quale la nostra dichiarazione si riferisce, è conforme alle seguenti normative:

EN60065, EN55013, EN55020, EN61000-3-2 e EN61000-3-3.

In conformità con le condizioni delle direttive 73/23/EEC, 89/336/EEC e 93/68/EEC.

QUESTO PRODOTTO E' CONFORME

AL D.M. 28/08/95 N. 548

• **DECLARACIÓN DE CONFORMIDAD**

Declaramos bajo nuestra exclusiva responsabilidad que este producto al que hace referencia esta declaración, está conforme con los siguientes estándares:

EN60065, EN55013, EN55020, EN61000-3-2 y EN61000-3-3.

Siguiendo las provisiones de las Directivas 73/23/EEC, 89/336/EEC y 93/68/EEC.

• **EENVORMIGHEIDSVERKLARING**

Wij verklaren uitsluitend op onze verantwoordelijkheid dat dit produkt, waarop deze verklaring betrekking heeft, in overeenstemming is met de volgende normen:

EN60065, EN55013, EN55020, EN61000-3-2 en EN61000-3-3.

Volgens de bepalingen van de Richtlijnen 73/23/EEC, 89/336/EEC en 93/68/EEC.

• **ÖVERENSSTÄMMELSESINTYG**

Härmed intygas helt på eget ansvar att denna produkt, vilken detta intyg avser, uppfyller följande standarder:

EN60065, EN55013, EN55020, EN61000-3-2 och EN61000-3-3.

Enligt stadgarna i direktiv 73/23/EEC, 89/336/EEC och 93/68/EEC.

■ INTRODUCTION

Thank you very much for purchasing the DENON DN-X1500 DJ MIXER. DENON proudly presents this advanced DJ MIXER to audiophiles and music lovers as a further proof of DENON's non-compromising pursuit of the ultimate in sound quality. The high quality performance and easy operation are certain to provide you with many hours of outstanding listening pleasure.

– TABLE OF CONTENTS –

1	MAIN FEATURES	5	6	FADER START	10
2	INSTALLATION	5	7	EFFECTOR.....	11
3	PART NAMES AND FUNCTIONS	5 ~ 7	8	SAMPLER.....	12
4	CONNECTIONS	8	9	PFL (Pre Fader Level)	12
5	SPECIFICATIONS.....	9	10	PRESET	13

■ ACCESSORIES

Please check to make sure the following items are included with the main unit in the carton:

① Operating instructions.....	1
-------------------------------	---

1 MAIN FEATURES

1. Matrix input assignment

8 input sources is freely assignable to each channels.

2. Penny & Giles Crossfader

Smooth and reliable mixing is excelled by Penny & Giles Crossfader.

3. Sampler

On-board digital Sampler can record up to 8 seconds CD quality sound. You can seamlessly Loop this Sampler or play it backwards (REVERSE). The pitch and output level of Sampler can be adjusted independently.

4. Internal Effector

Various sound effects can be performed. (DELAY, ECHO, PAN, TRANS, FILTER, FLANGER, KEY)

5. Auto BPM counter, BPM Lock, TAP and Manual BPM input

In addition to an Auto BPM counter and Tap function, the DN-X1500 is also equipped with the temporarily Lock function of the Auto BPM counter and the Manual BPM input function.

6. Channel Fader and Crossfader Start

The CD player can be started or stopped simply by increasing or decreasing the level of the Ch. Fader or by using the Crossfader left to right or right to left. (This function can only be used when the DENON CD players DN-S3000, DN-S5000, DN-D4000 or etc. is connected to the DN-X1500.)

7. Digital output

The DN-X1500 allows you to record directly to CD-R, MiniDisc or a hard disk device through it's exclusive coaxial digital output.

The digital output maintains a constant 44.1 kHz signal.

8. Enhanced SEND/RETURN terminals

8 LINE, 3 PHONO, 2 Microphone systems, 2 MASTER outputs, BOOTH output and REC output are provided independently. Effect SEND/RETURN terminals are also provided for a external effects processor.

9. 3-Band equalizer/gain

LOW, MID, HI and GAIN controls are available on every input channel.

10. Crossfader Contour

This feature allows adjusting the "shape" of the Crossfader response from a gentle curve for smooth, long running fades, to the steep pitch required for top performance cut and scratch effects.

11. Mic Post

This feature will pass the Mic signal into the BOOTH, REC output and DIGITAL output signal path.

In the OFF mode, the Mic signal will not be routed through the above outputs.

12. PFL (Pre Fader Level)

This feature provides a means to adjust the input level gain of each channel to avoid over loading. By making this adjustment in advance will insure a smooth transition between cross fades or channel fades.

13. Preset functions

It is possible to customise the machine to your preference by saving your favourite setting to internal memory. For items found in the presets, please see page 13.

2 INSTALLATION

When the DN-X1500 is installed inside a coffin or DJ booth, separate it from the foam (sponge), walls or other equipment to improve heat radiation.

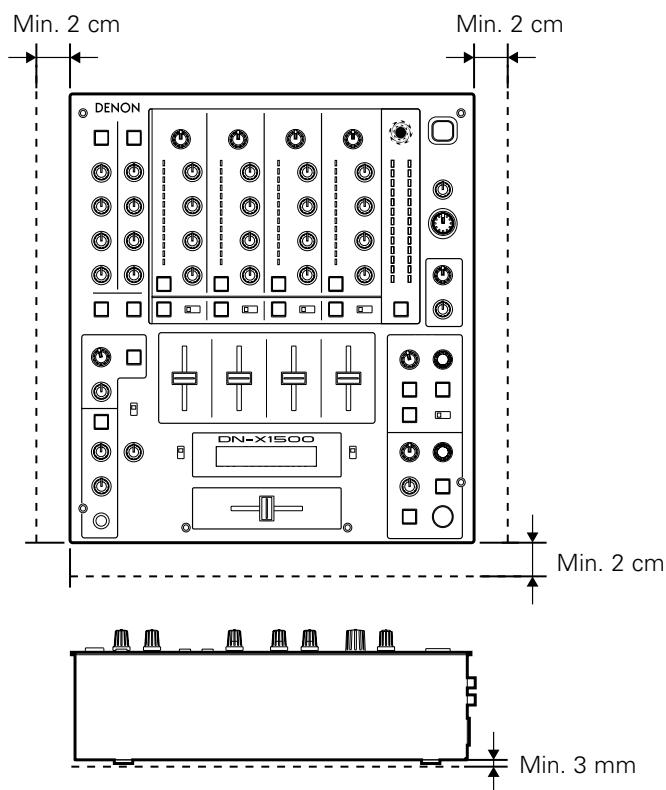

3 PART NAMES AND FUNCTIONS (Refer to page 3.)

(1) Top panel

1 Power operation switch (POWER)

- The power turns on when the button is switched from the off position (■) to the on position (■).
- The power turns off when the button is switched from the on position (■) to the off position (■).

2 MASTER BALANCE control

- Adjusts the L/R balance of the MASTER output.

3 MASTER LEVEL control

- Adjusts the level of the MASTER outputs.

4 BOOTH ASSIGN switch

- Selects the source of the BOOTH output.

5 BOOTH LEVEL control

- Adjusts the level of the BOOTH output.

6 SAMPLER ASSIGN switch

- Use this to select the source for Sampler recording.

7 SAMPLER MODE knob

- Use this to set the Sampler playback mode or edit the Sampler.
- Push this knob during the Sampler playback or recording, the Sampler playback or recording is stopped.

8 SAMPLER A button

- Push this button, the Sampler recording or playback starts.

9 SAMPLER B button

- Use this to set the Sampler B point.

10 CROSSFADER ASSIGN switch

A, B:

- The channel source is assigned to A or B of the Crossfader.

POST:

- Select when you don't assign the channel source into the Crossfader.

11 EFFECTS ASSIGN switch

- Use this to select the source of the internal Effector.

12 MODE PARAMETER knob

- Use this to set the effect mode and parameters.

13 EFFECTS WET/DRY control

- Use this to adjust the ratio of original and effected sound.

14 EFFECTS ON/OFF button

- Use this to switch the internal Effector function ON and OFF.

15 TAP button

• TAP:

When you push this button repeatedly, the AUTO mode turns off and starts measuring your Beats Per Minute (BPM) by tapping.

• LOCK:

When this button is pressed once while the auto BPM counter is operating, the data measured by the auto BPM counter is locked.

• AUTO:

When pushing the TAP button for 1 second, activates AUTO BPM mode.

The measured BPM is displayed in the BPM display.

• INPUT BPM:

When the TAP button is pressed and held in for more than 2 seconds, the BPM input mode is set and the BPM value can be input directly with the MODE PARAMETERS knob 12. When the button is pressed again, the BPM input mode is turned off.

16 CUE buttons

- Pressing in any or all of the CUE buttons routes the respective source to the headphone and meter cue sections. Pressing multiple buttons makes it possible to derive mixed sound from the selected sources.

17 CROSSFADER START A, B switches

- Use this to switch the Crossfader Start function ON and OFF.

18 Crossfader

- Controls the relative output level from the summed A and B Mixes. When the fader is at its far left, only the A Mix is heard from the outputs. As the fader is moved toward the right, the amount of B Mix is increased and the amount of A Mix is decreased. When the fader is centered, equal amounts of A and B Mixes are routed to the outputs. Fully right is all B Mix at the outputs.

19 Source input fader (Ch. Fader)

- Controls the level of the selected Input.

20 CROSSFADER CONTOUR control

- Allows adjusting the "shape" of the Crossfader response from a gentle curve for smooth, long running fades, to the steep pitch required for top performance cut and scratch effects.

21 HEADPHONE output jack

- Accepts 1/4" stereo headphone plugs.

22 HEADPHONE LEVEL control

- Adjusts the volume for the headphones.

23 HEADPHONE PAN control

- Serves two purposes...In the STEREO mode it changes the relative levels of the Cue and Program (CUE MASTER) mixed together in both earcups. In the SPLIT CUE (MONO) mode it changes the balance between the Mono Cue in the left ear cup and the Mono Program (MASTER) in the right.

24 SPLIT CUE button

- In the STEREO mode, this button feeds STEREO Program (CUE MASTER) and Cue to both earcups, in the SPLIT CUE (MONO) mode, the headphone circuit provides MONO Cue to the left ear and MONO Program (MASTER) to the right.
- In the STEREO mode, the meter indicates the stereo level in the LEFT and RIGHT Master Outputs. In the SPLIT CUE (MONO) mode, mono Cue level is displayed on the Left meter and mono Program (CUE MASTER) level is displayed on the Right meter.
- In the SPLIT CUE (MONO) mode, the button is lit.

25 EFFECT LOOP WET/DRY control

- Use this to adjust the ratio of original and effected sound.

26 CH FADER START switch

- Use this to switch the Channel Fader Start function ON and OFF.

27 EFFECT LOOP ASSIGN switch

- Use this to select the source of the external processor.

28 EFFECT LOOP ON/OFF button

- Routes the assigned signal through the external processor attached to the SEND/RETURN connectors on the rear.
- When the EFFECT is ON, the button is lit. (When the processor isn't connected, the button will blink when activated.)

29 TALK OVER ON/OFF button

- Use this to switch the Talk Over function ON and OFF.
- When the button is lit, level of signals except Mics is attenuated.
- The Talk Over attenuation level can be adjusted in the Preset mode.

NOTE:

When this button is pushed, volume changes rapidly.

30 MIC POST ON/OFF button

- Puts the Mic signals into the BOOTH, REC and DIGITAL out signal path.

31 MIC EQ controls

- Contour the frequency response of the MIC input -12 dB to $+12$ dB.
At the center position, sound is flat.

32 MIC LEVEL controls

- Adjusts the level of the Mic signal.

33 MIC ON/OFF buttons

- When the button is lit, Mic signal is transferred to output section, otherwise Mic input is muted.

34 INPUT ASSIGN (Input selectors)

- Select any source from eight inputs (PHONO1/LINE1, LINE2, PHONO2/LINE3, LINE4, PHONO3/LINE5, LINE6, LINE7, LINE8) for each channel independently.
- You also can assign the same input to several channels for creative mixing.

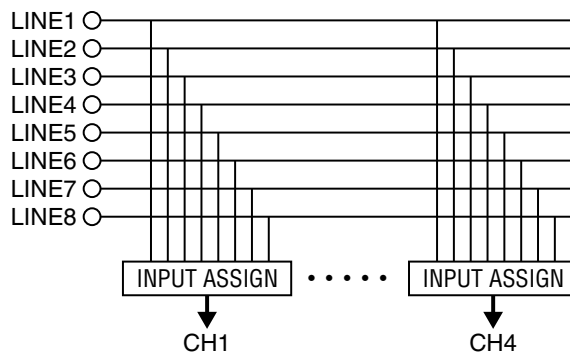

35 GAIN (Line input level controls)

- Adjusts the level of the selected input.
- You can adjust each GAIN volume to indicate 0dB on source level meter.

36 Source EQ controls

- Contour the frequency response of the selected inputs.
At the center position, sound is flat.

HI and MID:

- Adjusts the high-tone and mid-tone sound -40 dB to $+10$ dB.

LOW:

- Adjusts the low-tone sound -40 dB to $+6$ dB.

NOTE:

Clipping may occur if adjustments are set to harsh.

37 CUE MASTER level meter

- Displays the output level following MASTER LEVEL adjustment.
- Can switch between two display mode. See below 24.

38 Source level meters

- Displays the input level after adjusted with GAIN 35 and EQ 36 controls.

NOTE:

If this meter indicates over $+12$ dB, inputted sound may be clipped.

39 EQ ON/OFF buttons

- When this button is lit EQ is on, otherwise EQ is bypassed.

(2) Rear panel

40 LINE2, 4, 6, 7, 8 input jacks

- These stereo pairs of unbalanced RCA jacks are inputs for any line level device.

41 PHONO1, 2, 3 / LINE1, 3, 5 input jacks

- These stereo pairs of unbalanced RCA jacks are inputs for a PHONO (RIAA) stage for magnetic (MM) cartridges or a LINE stage suitable for any device, such as a CD player.

42 PHONO1, 2, 3 / LINE1, 3, 5 switches

- These switches change the input from PHONO to a LINE level inputs.
- These switches set a LINE level inputs when turntable is not connected.

43 Phono ground screw (GND)

- This screws provide a place to connect the ground wire from a turntable. This terminal is exclusively for a turntable grounding and not a safety earth ground.

44 AUX MIC input jack

- Accepts an balanced microphone with 1/4" TRS mono jacks.
- Pin layout: Tip=Hot Ring=Cold Sleeve=GND

45 MAIN MIC input connector

- Neutrik combo jack.
- Accepts either a balanced microphone with an XLR connector or a balanced microphone with 1/4" TRS mono jacks.
- Pin layout:
XLR: 1. GND 2. Hot 3. Cold
1/4" TRS: Tip=Hot Ring=Cold Sleeve=GND

46 Maintenance connector

NOTE:

This connector can be used only for firmware updating. Do not connect device, or may cause damage.

47 LINE2, 4, 6, 8 FADER output jacks

- Connect these jacks to the FADER input jacks of DN-S3000, DN-S5000, DN-D4000 and etc. using the 3.5 mm stereo mini cord.

48 SEND / RETURN jacks

- These 1/4" TS mono jacks allow external processing of the program signal.
- When connect monaural type effect processor, use Lch input and output.

49 DIGITAL OUT (COAXIAL) jack

- This RCA jack provides a digital output data. The signal is unaffected by the MASTER LEVEL control.
- We recommend using a 75 Ω /ohm RCA cord for best digital transfer. (available from any audio/video retailer)

50 REC OUT jacks

- This stereo pair of RCA jacks provide a line level output. The signal is unaffected by the MASTER LEVEL control.

51 BOOTH OUT jacks

- This stereo pair of RCA jacks provide a unbalanced line level output with independent top panel BOOTH LEVEL control.

52 MASTER OUT (UNBALANCED) jacks

- This stereo pair of RCA jacks provide a unbalanced line level output.
- Connect these jacks to the unbalanced analog input jacks on an amplifier or console.

53 LEVEL ATT

(Master out level attenuator)

- Use this to attenuate the MASTER output level. ($-\infty \sim 0$ dB)
- Reference is 0 dB.

54 MASTER OUT (BALANCED) connectors

- These XLR type connectors provide a balanced line level output.
- Connect these connectors to the balanced analog input connectors on an amplifier or console.
- Pin layout: 1. GND 2. Hot 3. Cold
- Applicable connector:
Cannon XLR-3-31 or equivalent.

NOTE:

Do not short-circuit the hot or cold pin with the GND pin.

55 MASTER MONO OUT ON/OFF switch

- When this switch is on, mixed L and R signal is outputted from the MASTER OUT (Both BALANCED and UNBALANCED).

(3) Display

56 Crossfader A assign indicators

- This indicator shows channels of assigned channel to Crossfader A side.

57 Preset mode indicators

58 Sampler mode indicators

SAMP:

- The Sampler sound is recorded.

LOOP:

- Playing Sampler in Loop mode.

REV.:

- Reverse Sampler playback.

59 Character display

- This displays various operational information, etc..
- [1] : CH-1 indicator
- [2] : CH-2 indicator
- [3] : CH-3 indicator
- [4] : CH-4 indicator

The number of assigned input source is displayed on the character display under these indicator.

60 Effect assign indicators

- Selected Effector source is indicated here.

61 Crossfader B assign indicators

- This indicator shows channels of assigned channel to Crossfader B side.

62 Effector BPM display

- This display indicates the BPM of the assigned source.

63 BPM mode indicators

AUTO:

- This indicator is lit, when the BPM mode is AUTO BPM.
- This indicator is flashed, when the AUTO BPM is locked.

MANUAL:

- This indicator is lit, when the BPM mode is manual BPM input. You can input desired BPM by MODE PARAMETER knob.

64 Cue button indicators

- Channels of CUE selected are indicated.

65 Cue BPM display (Auto count)

- This display indicates the BPM of the selected channel.

NOTE:

BPM will not be displayed, if 2 or more channels are selected.

5 SPECIFICATIONS

• Phono Inputs:	3 Stereo	Unbalanced RCA jacks
Input Impedance	50 k Ω /kohms	
Level	-50 dBV (3 mV)	
• Line Inputs:	5 Stereo	Unbalanced RCA jacks
Input Impedance	50 k Ω /kohms	
Level	-14 dBV (200 mV)	
• EQ Control (Line):	3 Bands	
[Auto EQ]		
Control Range & Frequency	HI: -33 dB (15 kHz) to +10 dB (8 kHz) MID: -40 dB (1 kHz) to +10 dB (1 kHz) LOW: -40 dB (60 Hz) to +6 dB (60 Hz)	
[Parametric EQ]		
Control Range	HI: -40 to +10 dB MID: -40 to +10 dB LOW: -40 to +6 dB	
Frequency	HI: 6 kHz to 20 kHz MID: 200 Hz to 6 kHz LOW: 20 Hz to 200 Hz	Default 13 kHz Default 1 kHz Default 100 Hz
• Return Inputs:	2 Mono	Unbalanced 1/4" TS jack
Input Impedance	50 k Ω /kohms	
Level	-14 dBV (200 mV)	
• Mic Inputs:	2 Mono	
Main Mic	Active Balanced	XLR and 1/4" TRS jack (1: GND, 2: Hot, 3: Cold) (Tip: Hot, Ring: Cold, Sleeve: GND)
Input Impedance	2 k Ω /kohms	
Level	-54 dBV (2 mV)	
Frequency Response	20 Hz to 20 kHz (\pm 3 dB)	
S/N	65dB	
Aux Mic	Active Balanced	1/4" TRS jack (Tip: Hot, Ring: Cold, Sleeve: GND)
Input Impedance	1 k Ω /kohms	
Level	-60 dBV (1 mV)	
Frequency Response	20 Hz to 20 kHz (\pm 3 dB)	
S/N	60dB	
• EQ Control (Mic):	3 Bands	
Control Range	HI: -12 to +12 dB MID: -12 to +12 dB LOW: -12 to +12 dB	
Frequency	HI: 10 kHz MID: 1 kHz LOW: 100 Hz	

• Master Output:		
Balanced	Stereo, Active Balanced	XLR jacks (1: GND, 2: Hot, 3: Cold)
Output Impedance	150 Ω /ohms	
Level	+4 dBu (1.23 V)	
Frequency Response	20 Hz to 20 kHz (± 2 dB)	
THD+N	Below 0.02 %	
S/N	85 dB (Line) (When noise gate function set with presets) 70 dB (Phono)	
Cross Talk	Over 70 dB	
Unbalanced	Stereo RCA jacks	
Output Impedance	1 k Ω /kohms	
Level	0 dBV (1 V)	
Frequency Response	20 Hz to 20 kHz (± 2 dB)	
THD+N	Below 0.02 %	
S/N	85 dB (Line) (When noise gate function set with presets) 70 dB (Phono)	
Cross Talk	Over 70 dB	
• Rec Output:	Stereo	Unbalanced RCA jacks
Output Impedance	1 k Ω /kohms	
Level	-10 dBV (316 mV)	
• Booth Output:	Stereo	Unbalanced RCA jacks
Output Impedance	1 k Ω /kohms	
Level	0 dBV (1 V)	
• Send Output:	2 mono	Unbalanced 1/4" TS jacks
Output Impedance	1 k Ω /kohms	
Level	-14 dBV (200 mV)	
• Headphone Output:	Stereo	
Output Impedance	100 Ω /ohms	
Level	0 dBV (1 V)	
• Digital Output:	Coaxial	IEC958 Type II
• Power Supply, Consumptions:		
USA, Canada	AC 120 V \pm 10 %, 60 Hz	45 W
Europe, Asia, Oceania	AC 230 V \pm 10 %, 50 Hz	45 W
Unit Size	310 (W) x 90 (D) x 327 (H) mm	
Mass	6.7 kg	

* Specifications and design are subject to change without notice for purpose of improvement.

6 FADER START

If the separately sold DN-S5000, DN-S3000, DN-D9000, DN-D4000 and etc. players are connected to LINE2, 4, 6 or 8, they can be started using the source input fader (Ch. Fader) or Crossfader, as long as the 3.5 mm stereo mini cords have been connected.

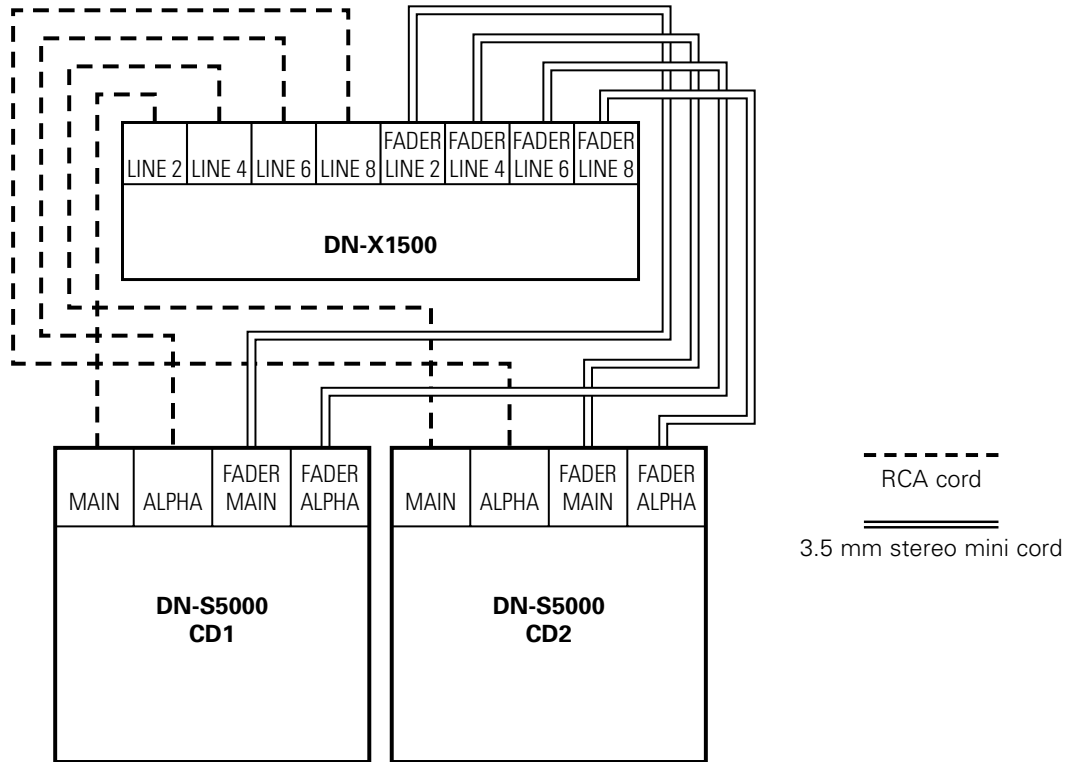

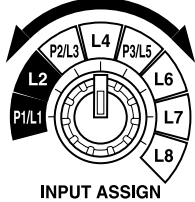
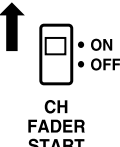
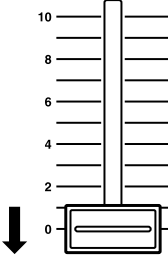
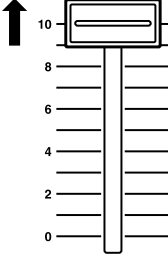

Channel Fader Start

1	<p>Turn the INPUT ASSIGN switch 34 to select the desired source from LINE2, 4, 6 or 8.</p>  <p style="text-align: center;">INPUT ASSIGN</p>
2	<p>Turn on the CH FADER START switch 26.</p>  <p style="text-align: center;">CH FADER START</p>
3	<p>Move the source input fader (Ch. Fader) 19 of CH-1, CH-2, CH-3 or CH-4 control all the way to the bottom.</p> 
4	<p>Set the standby mode on CD player.</p>
5	<p>When you want to start the player, move up the source input fader (Ch. Fader) 19 and the CD player will begin playing.</p> 

NOTE:

- Channel Fader Start and Crossfader Start for the same source will not operate simultaneously. You must select from either one. If both CH FADER START and CROSSFADER START A, B switches are ON, priority will be the cross fader.

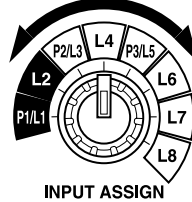
Crossfader Start

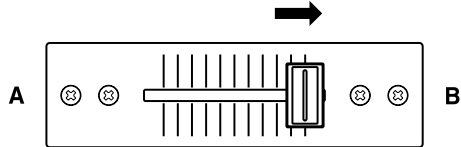
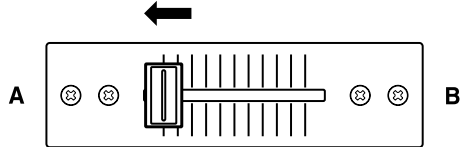
1	<p>Turn the INPUT ASSIGN switch 34 to select the desired source from LINE2, 4, 6 or 8.</p>  <p style="text-align: center;">INPUT ASSIGN</p>
2	<p>Using the CROSSFADER ASSIGN switch 10, assign the channel or Sampler source into A or B of Crossfader.</p>  <p style="text-align: center;">CROSSFADER ASSIGN</p>
3	<p>Turn on the CROSSFADER START A, B switches 17.</p>  <p style="text-align: center;">CROSS FADER START A CROSS FADER START B</p>
4	<p>Slide the Crossfader 18 all the way in direction opposite the source you want to start. (In the following example, startup is done with the CD player connected set to Assign A.)</p> 
5	<p>Set the standby mode on CD player.</p>
6	<p>Use the CROSSFADER CONTOUR control 20 to control the cross fader startup curve.</p>
7	<p>When the Crossfader 18 is slid in the opposite direction, CD player play will begin.</p> 

7 EFFECTOR

1	<p>Select the source of Effector</p> <ul style="list-style-type: none"> Turn the ASSIGN switch ⑪ in the EFFECTS part to select the desired source.
2	<p>Set BPM (See page 6.)</p> <ul style="list-style-type: none"> Using the TAP button ⑮ and the MODE PARAMETERS knob ⑫, the BPM can be set with either the AUTO BPM, TAP or MANUAL input. <p>[About BPM]</p> <ul style="list-style-type: none"> When using the auto BPM function, perform the lock operation. When the BPM changes, the effect sound changes. When the auto BPM cannot be measured, use the TAP button and input the BPM. If you know the selection's BPM, we recommend inputting it in the manual mode.
3	<p>Select Effector mode (First selection)</p> <p>※ Echo2, Filter2, Pan, Trans and Key% are set in the preset mode.</p> <ul style="list-style-type: none"> Turn the MODE PARAMETERS knob ⑫ to select prefer effect mode. The effect mode changes and is displayed on display by one click. <div style="text-align: center;"> <pre> graph LR None --> Delay Delay <--> Echo1 Echo1 <--> Echo2 Echo2 --> Flanger Flanger <--> Filter2 Filter2 <--> Filter1 Filter1 --> Pan Pan <--> Trans Trans <--> KeyPct </pre> </div> <ul style="list-style-type: none"> After select prefer effect then push MODE PARAMETERS knob ⑫ to complete the first selection and go to the second selection.
4	<p>Beat effect and manual effect mode (Second selection for Delay, Echo1, Echo2, Pan, Trans, Filter2 and Flanger)</p> <p>※ Manual effect mode is set in the preset mode.</p> <p>※ The default is "Manual OFF". In this case, skip to third selection (step 5).</p> <ul style="list-style-type: none"> All effect modes excluded Key and Filter1 work with beat mode or manual mode. You can choose beat or manual with MODE PARAMETERS knob ⑫. After select prefer mode then push MODE PARAMETERS knob ⑫ to complete the second selection and go to the third selection.

5	<p>Time select (Third selection for Delay, Echo1, Echo2, Pan, Trans, Filter2 and Flanger)</p> <ul style="list-style-type: none"> Beat mode: Time parameter of effect is determined based on countered BPM. BPM is countered automatically in AUTO BPM mode or manually inputted in MANUAL mode or tapped in TAP mode. Using the MODE PARAMETERS knob ⑫, you can select time parameter. Selected time parameter is used soon. Manual mode: Time parameter of effect is inputted with MODE PARAMETERS knob ⑫. Selected time parameter is used soon. After select prefer parameter then push MODE PARAMETERS knob ⑫ to return to the first selection.
6	<p>Key% select (Second selection for Key%)</p> <ul style="list-style-type: none"> Key is selected with MODE PARAMETERS knob ⑫. Selected Key is used soon. After select prefer parameter then push MODE PARAMETERS knob ⑫ to return to the first selection.
7	<p>WET/DRY control</p> <ul style="list-style-type: none"> DN-X1500 can adjust the mixing ratio of source sound and effected sound using WET/DRY control ⑬. When turn to WET position Effector sound is only outputted. Otherwise at DRY position only source sound is outputted.
8	<p>Effector On/Off</p> <ul style="list-style-type: none"> Pushing ON/OFF button ⑭ to turn on and off the Effector. When the Effector on, this button lights.
9	<p>Effector Cue</p> <ul style="list-style-type: none"> When the EFFECTS CUE button ⑯ is pressed, you can check the effected sound by headphone. The sound is unaffected by the EFFECTS ON/OFF button ⑭.

First selection	Second selection	Third selection
Delay	Beat Effect mode	Delay time is selectable 1/4, 1/2, 3/4, 1/1, 2/1, 4/1, 8/1 of BPM.
	Manual input mode	Delay time can be set 1 to 3500 msec.
Echo 1 (Loop Echo) • When the WET/DRY control is turned clockwise, the Echo sound is looped.	Beat Effect mode	Echo time is selectable 1/4, 1/2, 3/4, 1/1, 2/1, 4/1, 8/1 of BPM.
	Manual input mode	Echo time can be set 1 to 3500 msec.
Echo 2 (Normal Echo) ※ Preset functions	Beat Effect mode	Echo time is selectable 1/4, 1/2, 3/4, 1/1, 2/1, 4/1, 8/1 of BPM.
	Manual input mode	Echo time can be set 1 to 3500 msec.
Filter 1 (Manual Filter) • When the WET/DRY control is turned, the Filter frequency is moved.	Filter type is selectable LowP.F. (Low-pass filter), MidP.F. (Band-pass filter), Hi P.F. (High-pass filter)	—
Filter 2 (Auto Filter) ※ Preset functions	Beat Effect mode	Filter time is selectable 1/2, 1, 2, 4, 8, 16, 32 of BPM.
	Manual input mode	Filter time can be set 10 to 16000 msec.
Flanger	Beat Effect mode	Flanger time is selectable 1/2, 1, 2, 4, 8, 16, 32 of BPM.
	Manual input mode	Flanger time can be set 10 to 16000 msec.
Pan ※ Preset functions	Beat Effect mode	Panning time is selectable 1/4, 1/2, 3/4, 1/1, 2/1, 4/1, 8/1 of BPM.
	Manual input mode	Panning time can be set 10 to 16000 msec.
Trans ※ Preset functions	Beat Effect mode	Trans time is selectable 1/4, 1/2, 3/4, 1/1, 2/1, 4/1, 8/1 of BPM.
	Manual input mode	Trans time can be set 10 to 16000 msec.
Key % ※ Preset functions	Key% is selectable -100 % to +100 %.	—

8 SAMPLER

Sampler playback

1	<p>Select the source of Sampler</p> <ul style="list-style-type: none"> Turn the ASSIGN switch 6 in the SAMPLER part to select the desired source.
2	<p>Record in Sampler</p> <p>When the A button 8 is pushed, the sound of the selected source is recorded to Sampler memory up to 8 seconds.</p> <ul style="list-style-type: none"> The A button 8 flashes after recording starts. When the recording is completed, B button 9 lights up.
3	<p>Setting B point / Stop recording</p> <p>When the B button 9 is pushed during recording, the B point is set.</p> <ul style="list-style-type: none"> Recording continues for approximately 8 seconds without stopping after set B point. If the B point is not set, recording end point set as B point automatically.
4	<p>Setting the Sampler sound level</p> <p>The sound level (volume) can be set for Sampler.</p> <ul style="list-style-type: none"> To select "S_Level" turn the MODE knob 7 and push. Turn the MODE knob 7 and select between "-14 dB" and "+6 dB".
5-1	<p>Select Sampler play mode</p> <p>You can select play mode for Sampler when Sampler playback stop.</p> <p>Loop (default): Sampler playback continues with looping.</p> <p>Single: Sampler playback stops at B point.</p> <p>Stutter: Sampler is played while the A button 8 is pressed and held down.</p> <p>Loop + Reverse: Reverse Sampler playback continues with looping.</p> <p>Single + Reverse: Reverse Sampler stops at A point.</p> <p>Stutter + Reverse: Reverse Sampler is played while the A button 8 is pressed and held down.</p> <p>Exit B: Sampler playback continues over B point up to recording length.</p>

5-2	<p>To select Loop/Reverse mode, turn the MODE knob 7 then push after recording and before playing.</p> <p>① Play mode:</p> <ul style="list-style-type: none"> To select "P_Mode" turn the MODE knob 7 and push. Turn the MODE knob 7 and select "Loop", "Exit B", "Single" or "Stutter". <p>② Play direction:</p> <ul style="list-style-type: none"> To select "DirMode" turn the MODE knob 7 and push. Turn the MODE knob 7 and select "Forward" or "Reverse".
6	<p>Play Sampler sound</p> <ul style="list-style-type: none"> Playback of the Sampler sound starts when the A button 8 is pushed after recording has completed. To stop the Sampler sound, push the MODE knob 7. When the CROSSFADER ASSIGN switch 10 in the SAMPLER part is set A or B, you can perform the Sampler Fader Start by the Crossfader 18. See page 10.
7	<p>Moving Sampler B point</p> <ul style="list-style-type: none"> When the B button 9 is pushed during Sampler playback, the B point moves to the point at which the button was pushed, and Loop playback from point A starts.
8	<p>Setting the Sampler pitch</p> <p>The sound pitch can be set for Sampler.</p> <ul style="list-style-type: none"> To select "S_Pitch" turn the MODE knob 7 and push. Turn the MODE knob 7 and select between "-100 %" and "+100 %".
9	<p>Clearing the Sampler data</p> <ul style="list-style-type: none"> While pressing the MODE knob 7, push the A button 8 to clear the Sampler.
10	<p>Monitoring the Sampler data (SAMPLER CUE)</p> <ul style="list-style-type: none"> When the SAMPLER CUE button 16 is pressed, you can check the Sampler data. <p>NOTE: When the SAMPLER CUE button is lit, the Sampler sound is not output into the Crossfader or MASTER OUT.</p>

Sampler A/B Trim

1	Select A-B Trim mode <ul style="list-style-type: none">• To select "A/BTrim" turn the MODE knob ⑦ and push.
2	Select A point (in A-B Trim) <ul style="list-style-type: none">• Push the A button ⑧.• The A button ⑧ illumination flashes and Loop playback starts.
3	Trim A point <ul style="list-style-type: none">• Turn the MODE knob ⑦. You can move the A point.
4	Save the A point <ul style="list-style-type: none">• Push the MODE knob ⑦ to save new the A point.
5	Select B point (in A-B Trim) <ul style="list-style-type: none">• Select the A-B Trim mode and push the B button ⑨.• The B button ⑨ illumination flashes.
6	Trim B point <ul style="list-style-type: none">• Turn the MODE knob ⑦. You can move the B point.
7	Save the B point <ul style="list-style-type: none">• Push the MODE knob ⑦ to save new the B point.

9 PFL (Pre Fader Level)

1. Press the SPLIT CUE button ⑳.
2. Press the CUE button ⑯ that you wish to monitor 1~4 (make sure your source is playing).
3. Turn the GAIN control ㉓ until the meters peak at the 0 dB level.
4. Perform your mix using the Crossfader ⑰ or Ch. Fader ⑱ at your desire.

NOTES:

- For proper operation, your channel levels should always be set to or left on reference line 8.
- This adjustment can be made even if the Ch. Fader is set to zero level.

10 PRESET

1. Preset mode

- ① Turn the EFFECTS ASSIGN switch **11** to select "OFF".
- ② The preset mode is available when the TAP button **15** is pushed for more than 2 seconds.
- ③ Turn the MODE PARAMETERS knob **12** to select the preset item.
- ④ After selecting an item, push the MODE PARAMETERS knob **12** to select the preset data.
- ⑤ To change other preset items, repeat these steps.
- ⑥ To exit from preset mode, press the TAP button **15**.

2. Preset items and data

The "*" mark next to the data indicates the default value.

- (1) EQ Mode : EQ sound can select Auto or Parametric.
EQMode : Auto* / Para.
- (2) High EQ Frequency :
When EQ mode is selected "Para.", you can select high range frequency of 3 band EQ 6 kHz to 20 kHz.
HEQFreq : xxx Hz (13 kHz*)
- (3) Middle EQ Frequency :
When EQ mode is selected "Para.", you can select middle range frequency of 3 band EQ 200 Hz to 6 kHz.
MEQFreq : xxx Hz (1 kHz*)
- (4) Low EQ Frequency :
When EQ mode is selected "Para.", you can select low range frequency of 3 band EQ 20 Hz to 200 Hz.
LEQFreq : xxx Hz (100 Hz*)
- (5) High EQ Q :
When EQ mode is selected "Para.", you can select high range Q of 3 band EQ.
HI_EQ_Q : Wide / Normal* / Narrow
- (6) Middle EQ Q :
When EQ mode is selected "Para.", you can select middle range Q of 3 band EQ.
MIDEQ_Q : Wide / Normal* / Narrow
- (7) Low EQ Q :
When EQ mode is selected "Para.", you can select low range Q of 3 band EQ.
LOWEQ_Q : Wide / Normal* / Narrow
- (8) Headphone EQ :
Select EQ of headphone, High range boost, Low range boost or High + Low range boost.
H/P_EQ : Normal* / H_Boost / L_Boost / HLBoost
- (9) Channel Fader Curve : Select the startup curve of channel fader.
CHCurve : Slow / Normal* / Sharp
- (10) Crossfader Curve : Set the startup curve of Crossfader.
CRCurve : Normal / Sharp*
- (11) Auto BPM : Auto BPM displays when the CUE button **16** is pressed.
AutoBPM : ON / OFF*
- (12) Talk Over Level : You can select decreased level of the Talk Over function.
T.Over : -6 dB / -10 dB / -20 dB*
- (13) Effector Manual mode ON/OFF :
Setting of whether or not to perform the Manual parameter mode of the internal Effector.
Manual Eff. : ON / OFF*
- (14) Echo2 (Normal Echo) ON/OFF :
Setting of whether or not to perform the Echo2 (Normal Echo) of the internal Effector.
Echo 2 : ON / OFF*

- (15) Filter2 (Auto Filter) ON/OFF :
Setting of whether or not to perform the Filter2 (Auto Filter) of the internal Effector.
Filter 2 : ON / OFF*
- (16) Pan ON/OFF :
Setting of whether or not to perform the Pan of the internal Effector.
Pan : ON / OFF*
- (17) Trans ON/OFF :
Setting of whether or not to perform the Trans of the internal Effector.
Trans : ON / OFF*
- (18) Key% ON/OFF :
Setting of whether or not to perform the Key of the internal Effector.
Key% ↑ ↓ : ON / OFF*
- (19) Noise Gate (CH) :
Setting of the function for attenuating the noise of the signals output from channels 1 to 4.
N.Gate CH : OFF* / Low / Hi
- (20) Noise Gate (MIC) :
Setting of the function for attenuating the noise of the MIC signals.
N.Gate Mic : OFF* / ON

NOTES:

- The Noise Gate function is a function for attenuating the noise on the analog circuitry using internal digital signal processing. Set it as desired.
- With the Noise Gate Function, the sound may seem distorted, for example when low level input signals are input or when the level of the input signals is set low with the GAIN control.

- (21) Display the microprocessor version. ("xxxx" is a number.)
Version : Sysxxxx / Panxxxx / Dspxxxx
- (22) Preset Clear : Set all the preset data back to factory defaults. ("P.Init?")
- ① To clear the PRESET data, push the MODE PARAMETERS knob **12**.
 - "InitOK?" displays on the character display.
 - ② Push the MODE PARAMETERS knob **12** again and start to clear the preset data.
 - "Preset" and "Initial" are displayed on the character display while data clearing.

DENON, Ltd.

16-11, YUSHIMA 3-CHOME, BUNKYO-KU, TOKYO 113-0034, JAPAN

Telephone: (03) 3837-5321