

DENON

TABLE TOP SINGLE CD PLAYER

DN-S5000

OPERATING INSTRUCTIONS

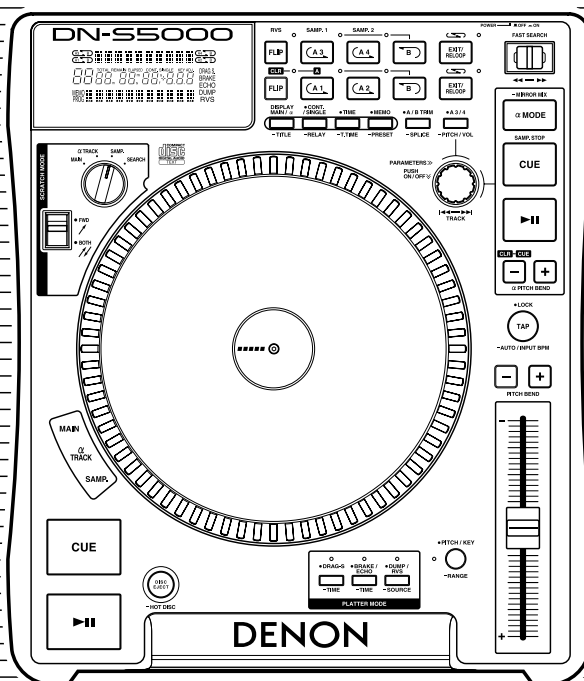



CAUTION
RISK OF ELECTRIC SHOCK
DO NOT OPEN



CAUTION: TO REDUCE THE RISK OF ELECTRIC SHOCK, DO NOT REMOVE COVER (OR BACK). NO USER SERVICEABLE PARTS INSIDE. REFER SERVICING TO QUALIFIED SERVICE PERSONNEL.



The lightning flash with arrowhead symbol, within an equilateral triangle, is intended to alert the user to the presence of uninsulated "dangerous voltage" within the product's enclosure that may be of sufficient magnitude to constitute a risk of electric shock to persons.



The exclamation point within an equilateral triangle is intended to alert the user to the presence of important operating and maintenance (servicing) instructions in the literature accompanying the appliance.

WARNING: TO PREVENT FIRE OR SHOCK HAZARD, DO NOT EXPOSE THIS APPLIANCE TO RAIN OR MOISTURE.

CAUTION:

1. Handle the power supply cord carefully

Do not damage or deform the power supply cord. If it is damaged or deformed, it may cause electric shock or malfunction when used. When removing from wall outlet, be sure to remove by holding the plug attachment and not by pulling the cord.

2. Do not open the top cover

In order to prevent electric shock, do not open the top cover. If problems occur, contact your DENON dealer.

3. Do not place anything inside

Do not place metal objects or spill liquid inside the CD player. Electric shock or malfunction may result.

Please, record and retain the Model name and serial number of your set shown on the rating label.

Model No. DN-S5000 Serial No. _____

NOTE:

This CD player uses the semiconductor laser. To allow you to enjoy music at a stable operation, it is recommended to use this in a room of 5 °C (41 °F) -35 °C (95 °F).

CLASS 1 LASER PRODUCT
LUOKAN 1 LASERLAITE
KLASS 1 LASERAPPARAT

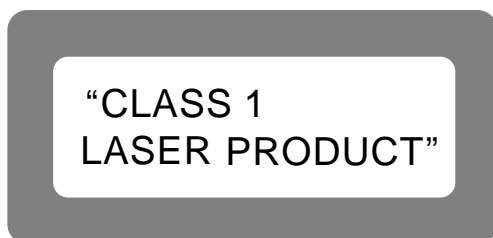

ADVARSEL: USYNLIG LASERSTRÅLING VED ÅBNING, NÅR SIKKERHEDSAFBRYDERE ER UDE AF FUNKTION. UNDGÅ UDSAETTELSE FOR STRÅLING.

VAROITUS! LAITTEEN KÄYTTÄMINEN MUULLA KUIN TÄSSÄ KÄYTTÖOHJEESSA MAINITULLA TAVALLA SAATTAA ALTISTAA KÄYTTÄJÄN TURVALLISUUSLUOKAN 1 YLITÄVÄLLE NÄKYMÄMTTÖMÄLLE LASERSÄTEILYLLE.

VARNING- OM APPARATEN ANVÄNDS PÅ ANNAT SÄTT ÄN I DENNA BRUKSANVISNING SPECIFICERATS, KAN ANVÄNDAREN UTSÄTTAS FÖR OSYNLIG LASERSTRÅLNING SOM ÖVERSKRIDER GRÄNSEN FÖR LASERKLASS 1.

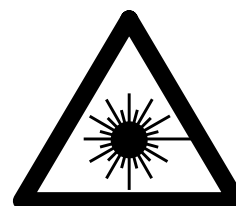

LABELS (for U.S.A. model only)

CERTIFICATION

THIS PRODUCT COMPLIES WITH DHHS RULES 21 CFR SUBCHAPTER J APPLICABLE AT DATE OF MANUFACTURE.

CAUTION:

USE OF CONTROLS OR ADJUSTMENTS OR PERFORMANCE OF PROCEDURES OTHER THAN THOSE SPECIFIED HEREIN MAY RESULT IN HAZARDOUS RADIATION EXPOSURE.

THE COMPACT DISC PLAYER SHOULD NOT BE ADJUSTED OR REPAIRED BY ANYONE EXCEPT PROPERLY QUALIFIED SERVICE PERSONNEL.

This device complies with Part 15 of the FCC Rules. Operation is subject to the following two conditions : (1) This device may not cause harmful interference, and (2) this device must accept any interference received, including interference that may cause undesired operation.

This Class B digital apparatus meets all requirements of the Canadian Interference-Causing Equipment Regulations.

Cet appareil numérique de la classe B respecte toutes les exigences du Règlement sur le matériel brouilleur du Canada.

SAFETY INSTRUCTIONS

1. Read Instructions – All the safety and operating instructions should be read before the product is operated.
2. Retain Instructions – The safety and operating instructions should be retained for future reference.
3. Heed Warnings – All warnings on the product and in the operating instructions should be adhered to.
4. Follow Instructions – All operating and use instructions should be followed.
5. Cleaning – Unplug this product from the wall outlet before cleaning. Do not use liquid cleaners or aerosol cleaners.
6. Attachments – Do not use attachments not recommended by the product manufacturer as they may cause hazards.
7. Water and Moisture – Do not use this product near water – for example, near a bath tub, wash bowl, kitchen sink, or laundry tub; in a wet basement; or near a swimming pool; and the like.
8. Accessories – Do not place this product on an unstable cart, stand, tripod, bracket, or table. The product may fall, causing serious injury to a child or adult, and serious damage to the product. Use only with a cart, stand, tripod, bracket, or table recommended by the manufacturer, or sold with the product. Any mounting of the product should follow the manufacturer's instructions, and should use a mounting accessory recommended by the manufacturer.
9. A product and cart combination should be moved with care. Quick stops, excessive force, and uneven surfaces may cause the product and cart combination to overturn.
10. Ventilation – Slots and openings in the cabinet are provided for ventilation and to ensure reliable operation of the product and to protect it from overheating, and these openings must not be blocked or covered. The openings should never be blocked by placing the product on a bed, sofa, rug, or other similar surface. This product should not be placed in a built-in installation such as a bookcase or rack unless proper ventilation is provided or the manufacturer's instructions have been adhered to.
11. Power Sources – This product should be operated only from the type of power source indicated on the marking label. If you are not sure of the type of power supply to your home, consult your product dealer or local power company. For products intended to operate from battery power, or other sources, refer to the operating instructions.
12. Grounding or Polarization – This product may be equipped with a polarized alternating-current line plug (a plug having one blade wider than the other). This plug will fit into the power outlet only one way. This is a safety feature. If you are unable to insert the plug fully into the outlet, try reversing the plug. If the plug should still fail to fit, contact your electrician to replace your obsolete outlet. Do not defeat the safety purpose of the polarized plug.

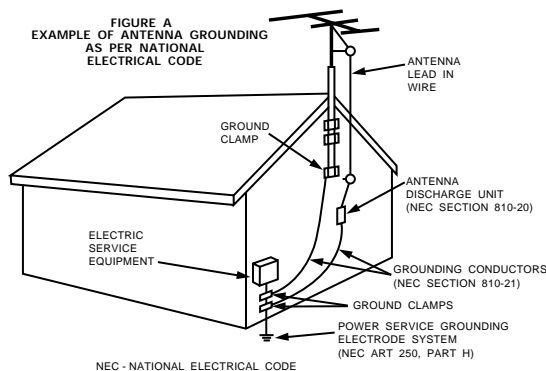

13. Power-Cord Protection – Power-supply cords should be routed so that they are not likely to be walked on or pinched by items placed upon or against them, paying particular attention to cords at plugs, convenience receptacles, and the point where they exit from the product.
15. Outdoor Antenna Grounding – If an outside antenna or cable system is connected to the product, be sure the antenna or cable system is grounded so as to provide some protection against voltage surges and built-up static charges. Article 810 of the National Electrical Code, ANSI/NFPA 70, provides information with regard to proper grounding of the mast and supporting structure, grounding of the lead-in wire to an antenna discharge unit, size of grounding conductors, location of antenna-discharge unit, connection to grounding electrodes, and requirements for the grounding electrode. See Figure A.
16. Lightning – For added protection for this product during a lightning storm, or when it is left unattended and unused for long periods of time, unplug it from the wall outlet and disconnect the antenna or cable system. This will prevent damage to the product due to lightning and power-line surges.
17. Power Lines – An outside antenna system should not be located in the vicinity of overhead power lines or other electric light or power circuits, or where it can fall into such power lines or circuits. When installing an outside antenna system, extreme care should be taken to keep from touching such power lines or circuits as contact with them might be fatal.
18. Overloading – Do not overload wall outlets, extension cords, or integral convenience receptacles as this can result in a risk of fire or electric shock.
19. Object and Liquid Entry – Never push objects of any kind into this product through openings as they may touch dangerous voltage points or short-out parts that could result in a fire or electric shock. Never spill liquid of any kind on the product.
20. Servicing – Do not attempt to service this product yourself as opening or removing covers may expose you to dangerous voltage or other hazards. Refer all servicing to qualified service personnel.
21. Damage Requiring Service – Unplug this product from the wall outlet and refer servicing to qualified service personnel under the following conditions:
 - a) When the power-supply cord or plug is damaged,
 - b) If liquid has been spilled, or objects have fallen into the product,
 - c) If the product has been exposed to rain or water,
 - d) If the product does not operate normally by following the operating instructions. Adjust only those controls that are covered by the operating instructions as an improper adjustment of other controls may result in damage and will often require extensive work by a qualified technician to restore the product to its normal operation,
 - e) If the product has been dropped or damaged in any way, and
 - f) When the product exhibits a distinct change in performance – this indicates a need for service.
22. Replacement Parts – When replacement parts are required, be sure the service technician has used replacement parts specified by the manufacturer or have the same characteristics as the original part. Unauthorized substitutions may result in fire, electric shock, or other hazards.
23. Safety Check – Upon completion of any service or repairs to this product, ask the service technician to perform safety checks to determine that the product is in proper operating condition.
24. Wall or Ceiling Mounting – The product should be mounted to a wall or ceiling only as recommended by the manufacturer.
25. Heat – The product should be situated away from heat sources such as radiators, heat registers, stoves, or other products (including amplifiers) that produce heat.

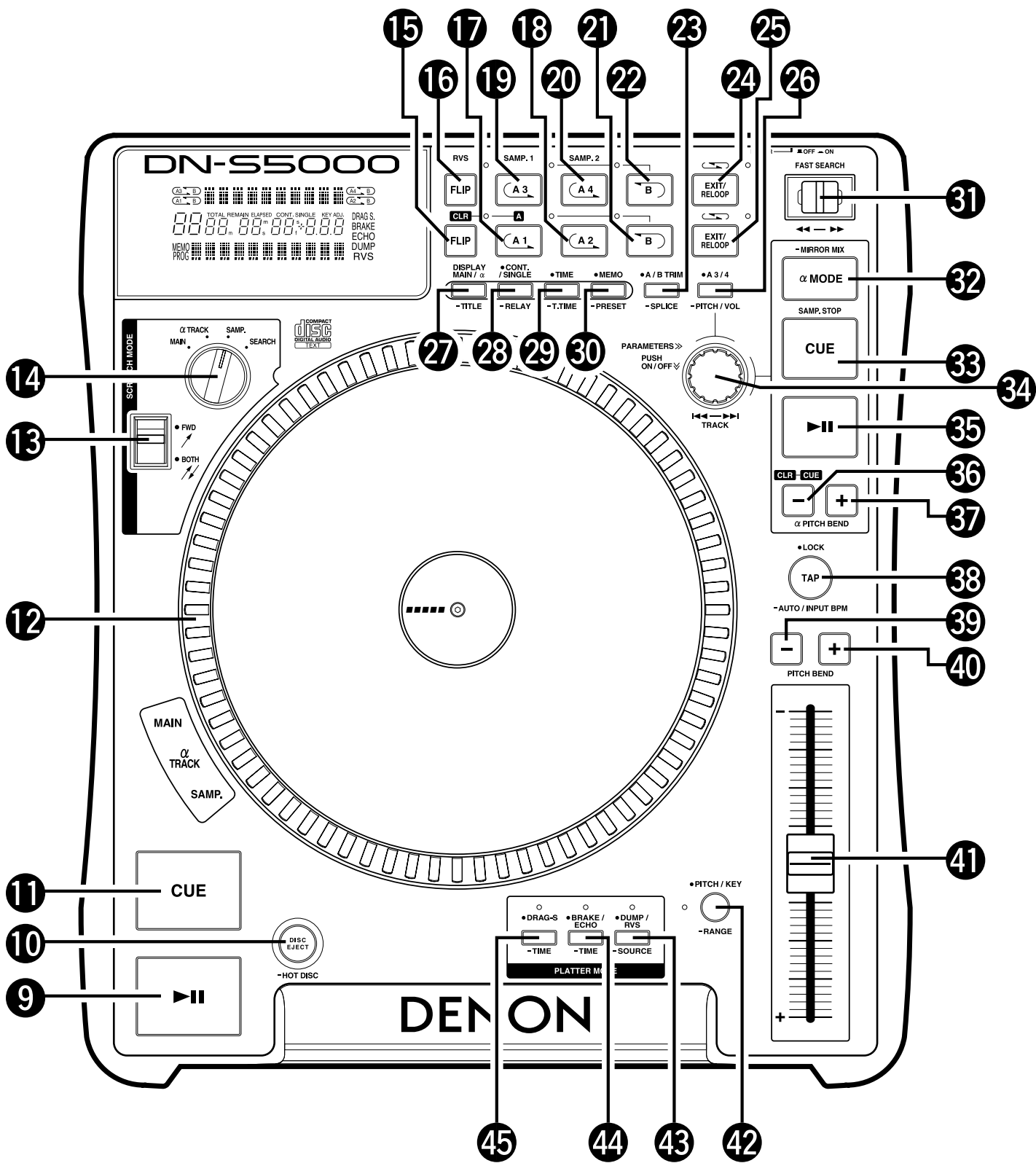

FRONT PANEL DIAGRAM

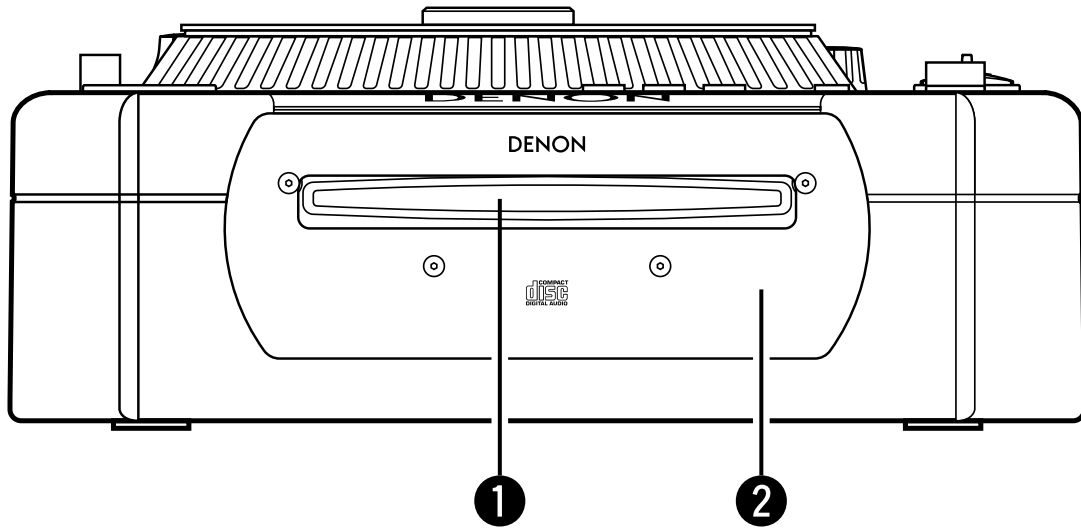

REAR PANEL DIAGRAM /

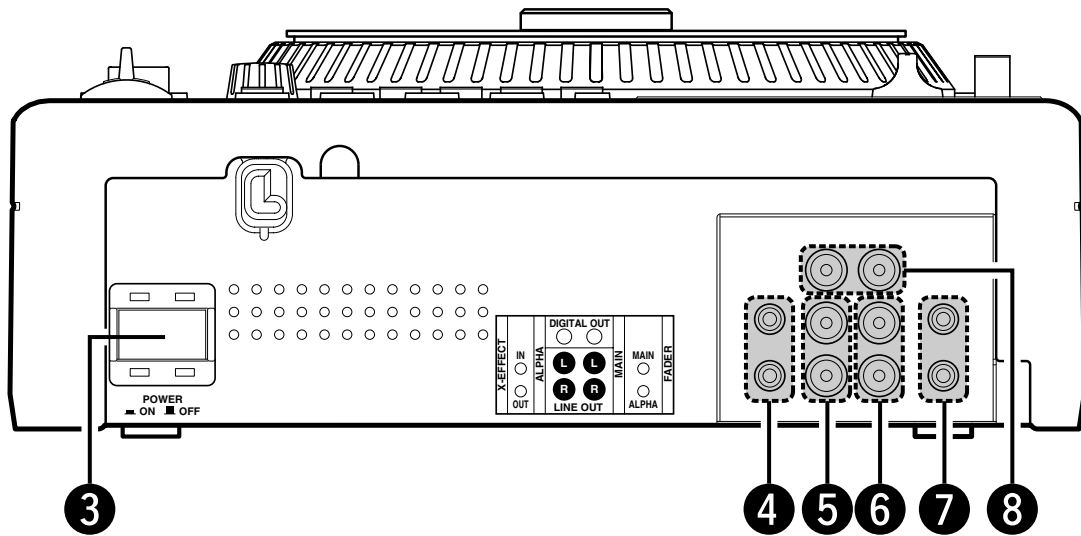

NOTE ON USE

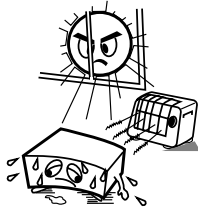

- Avoid high temperatures. Allow for sufficient heat dispersion when installed on a rack.
- Vermeiden Sie hohe Temperaturen. Beachten Sie, daß eine ausreichend Luftzirkulation gewährleistet wird, wenn das Gerät auf ein Regal gestellt wird.
- Eviter des températures élevées. Tenir compte d'une dispersion de chaleur suffisante lors de l'installation sur une étagère.
- Evite altas temperaturas. Permite la suficiente dispersión del calor cuando está instalado en la consola.
- Vermijd hoge temperaturen. Zorg voor een degelijk hitteafvoer indien het apparaat op een rek wordt geplaatst.
- Undvik höga temperaturer. Se till att det finns möjlighet till god värmeavledning vid montering i ett rack.

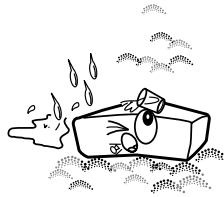

- Keep the set free from moisture, water, and dust.
- Halten Sie das Gerät von Feuchtigkeit, Wasser und Staub fern.
- Protéger l'appareil contre l'humidité, l'eau et la poussière.
- Mantenga el equipo libre de humedad, agua y polvo.
- Laat geen vochtigheid, water of stof in het apparaat binnendringen.
- Utsätt inte apparaten för fukt, vatten och damm.

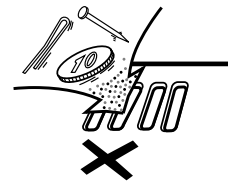

- Do not let foreign objects in the set.
- Keine fremden Gegenstände in das Gerät kommen lassen.
- Ne pas laisser des objets étrangers dans l'appareil.
- No deje objetos extraños dentro del equipo.
- Laat geen vreemde voorwerpen in dit apparaat vallen.
- Se till att främmande föremål inte tränger in i apparaten.

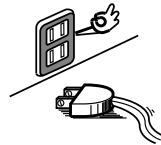

- Unplug the power cord when not using the set for long periods of time.
- Wenn das Gerät eine längere Zeit nicht verwendet werden soll, trennen Sie das Netzkabel vom Netzstecker.
- Débrancher le cordon d'alimentation lorsque l'appareil n'est pas utilisé pendant de longues périodes.
- Desconecte el cordón de energía cuando no utilice el equipo por mucho tiempo.
- Neem altijd het netsnoer uit het stopcontact wanneer het apparaat gedurende een lange periode niet wordt gebruikt.
- Koppla ur nätkabeln om apparaten inte kommer att användas i lång tid.



- Do not let insecticides, benzene, and thinner come in contact with the set.
- Lassen Sie das Gerät nicht mit Insektiziden, Benzin oder Verdünnungsmitteln in Berührung kommen.
- Ne pas mettre en contact des insecticides, du benzène et un diluant avec l'appareil.
- No permita el contacto de insecticidas, gasolina y diluyentes con el equipo.
- Laat geen insectenverdelgende middelen, benzine of verververdunner met dit apparaat in contact komen.
- Se till att inte insektsmedel på spraybruk, bensen och thinner kommer i kontakt med apparatens hölje.

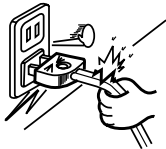

- Handle the power cord carefully. Hold the plug when unplugging the cord.
- Gehen Sie vorsichtig mit dem Netzkabel um. Halten Sie das Kabel am Stecker, wenn Sie den Stecker herausziehen.
- Manipuler le cordon d'alimentation avec précaution. Tenir la prise lors du débranchement du cordon.
- Maneje el cordón de energía con cuidado. Sostenga el enchufe cuando desconecte el cordón de energía.
- Hanteer het netsnoer voorzichtig. Houd het snoer bij de stekker vast wanneer deze moet worden aan- of losgekoppeld.
- Hantera nätkabeln varsamt. Håll i kabeln när den kopplas från el-uttaget.

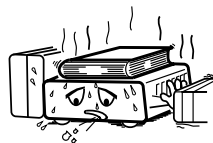

* (For sets with ventilation holes)

- Do not obstruct the ventilation holes.
- Die Belüftungsöffnungen dürfen nicht verdeckt werden.
- Ne pas obstruer les trous d'aération.
- No obstruya los orificios de ventilación.
- De ventilatieopeningen mogen niet worden beblokkeerd.
- Tapp inte till ventilationsöppningarna.



- Never disassemble or modify the set in any way.
- Versuchen Sie niemals das Gerät auseinander zu nehmen oder auf jegliche Art zu verändern.
- Ne jamais démonter ou modifier l'appareil d'une manière ou d'une autre.
- Nunca desarme o modifique el equipo de ninguna manera.
- Nooit dit apparaat demonteren of op andere wijze modifieren.
- Ta inte isär apparaten och försök inte bygga om den.

CAUTION

- The ventilation should not be impeded by covering the ventilation openings with items, such as newspapers, table-cloths, curtains, etc.
- No naked flame sources, such as lighted candles, should be placed on the apparatus.
- Please be care the environmental aspects of battery disposal.
- The apparatus shall not be exposed to dripping or splashing for use.
- No objects filled with liquids, such as vases, shall be placed on the apparatus.

• DECLARATION OF CONFORMITY

We declare under our sole responsibility that this product, to which this declaration relates, is in conformity with the following standards:

EN60065, EN55013, EN55020, EN61000-3-2 and EN61000-3-3.

Following the provisions of 73/23/EEC, 89/336/EEC and 93/68/EEC Directive.

• ÜBEREINSTIMMUNGSERKLÄRUNG

Wir erklären unter unserer Verantwortung, daß dieses Produkt, auf das sich diese Erklärung bezieht, den folgenden Standards entspricht:

EN60065, EN55013, EN55020, EN61000-3-2 und EN61000-3-3.

Entspricht den Verordnungen der Direktive 73/23/EEC, 89/336/EEC und 93/68/EEC.

• DECLARATION DE CONFORMITE

Nous déclarons sous notre seule responsabilité que l'appareil, auquel se réfère cette déclaration, est conforme aux standards suivants:

EN60065, EN55013, EN55020, EN61000-3-2 et EN61000-3-3.

D'après les dispositions de la Directive 73/23/EEC, 89/336/EEC et 93/68/EEC.

• DECLARACIÓN DE CONFORMIDAD

Declaramos bajo nuestra exclusiva responsabilidad que este producto al que hace referencia esta declaración, está conforme con los siguientes estándares:

EN60065, EN55013, EN55020, EN61000-3-2 y EN61000-3-3.

Siguiendo las provisiones de las Directivas 73/23/EEC, 89/336/EEC y 93/68/EEC.

• EENVORMIGHEIDSVERKLARING

Wij verklaren uitsluitend op onze verantwoordelijkheid dat dit produkt, waarop deze verklaring betrekking heeft, in overeenstemming is met de volgende normen:

EN60065, EN55013, EN55020, EN61000-3-2 en EN61000-3-3.

Volgens de bepalingen van de Richtlijnen 73/23/EEC, 89/336/EEC en 93/68/EEC.

• ÖVERENSSTÄMMELSEINTYG

Härmed intygas helt på eget ansvar att denna produkt, vilken detta intyg avser, uppfyller följande standarder:

EN60065, EN55013, EN55020, EN61000-3-2 och EN61000-3-3.

Enligt stadgarna i direktiv 73/23/EEC, 89/336/EEC och 93/68/EEC.



- Use compact discs that include the  mark.

CD's with special shapes (heart-shaped CD's, octagonal CD's etc.) cannot be played on this set. Attempting to do so may damage the set. Do not use such CD's.

- Benutzen Sie Compact Discs, die das  Zeichen tragen.

Speziell geformte CD's (herzförmige CDs, achteckige CDs, usw.) können auf dieser Anlage nicht abgespielt werden.

Der Versuch derartige CDs abzuspielen kann die Anlage beschädigen. Verzichten Sie auf die Benutzung solcher CDs.

- Utiliser des disques compacts portant le logo .

Des CD avec des formes spéciales (CD en forme de coeur, des CD octogonaux, etc.) ne peuvent pas être lus sur cet appareil.

Le fait de l'essayer, risque d'endommager le lecteur. Ne pas utiliser de tels CD.

- Use disc compactos con la marca .

En este equipo no es posible reproducir CDs con formas especiales (CDs con forma de corazón, CDs octogonales, etc.).

Si intenta hacerlo, el equipo podrá resultar dañado. No use este tipo de CDs.

- Gebruik compact discs voorzien van het logo .

CD's met speciale vormen (bijv. CD's in de vorm van een hart, achthoekige CD's, enz.) kunnen met dit toestel niet worden afgespeeld.

Wanneer u dit toch probeert, zal u het toestel beschadigen. Speel dergelijke CD's dus niet af.

- Använd CD-skivor med -märket.

Specialformade CD-skivor (hjärtformade, åttkantiga, m m) går inte att spela på den här apparaten.

Utrustningen kan skadas om du försöker göra detta. Använd inte CD-skivor av denna typ.



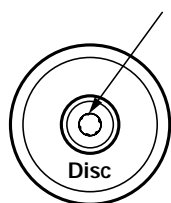

Residue
Rückstand
Résidu
Residuos
Oneffenheid
Plastrester

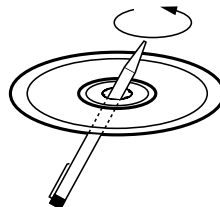

- The disc may not play normally if there is residue along the edges of the center hole.
- When using new discs in particular, use a pen, etc., to remove the residue.
- Die Disk kann nicht normal abgespielt werden, wenn sich ein Rückstand entlang der Mittellochenden befindet.
- Insbesondere, wenn Sie neue Disks benutzen, dann entfernen Sie mit einem Stift, etc. den Rückstand.
- Le disque peut ne pas être lu normalements s'il y a un résidu le long des bord du trou central.
- Lors de l'utilisation de nouveaux disques en particulier, utiliser un stylo à bille, etc., pour enlever le résidu.
- El disco no puede ser reproducido normalmente debido a la terminación deficiente de los bordes del agujero central.
- Para quitar estos residuos de material, especialmente cuando vaya a re-producir discos nuevos, utilice un bolígrafo, o algo similar.
- Het is mogelijk dat de disc niet normaal wordt weergegeven als de randen van het middengat van de schijf oneffenheden vertonen.
- Verwijder vooral bij gebruik van nieuwe discs de oneffenheden met een pen of iets dergelijks.
- Det kan uppstå fel vid CD-avspelningen om det finns plastrester kvar i mitthålet.
- Tänk på att bort dessa med en penna, e d, särskilt om CD-skivan är ny.

• FOR CANADA MODEL ONLY

CAUTION

TO PREVENT ELECTRIC SHOCK, MATCH WIDE BLADE OF PLUG TO WIDE SLOT, FULLY INSERT.

• POUR LES MODELE CANADIENS UNIQUEMENT

ATTENTION

POUR ÉVITER LES CHOCS ÉLECTRIQUES, INTERODUIRE LA LAME LA PLUS LARGE DE LA FICHE DANS LA BORNE CORRESPONDANTE DE LA PRISE ET POUSSER JUSQU' AU FOND.

CAUTION:

DO NOT USE THE DENON AMC-22 CD PICK-UP LENS CLEANER FOR THIS PRODUCT. THIS MIGHT DAMAGE THE LASER PICK-UP OF THIS PRODUCT.

ACHTUNG:

VERWENDEN SIE NICHT DEN CD-ABTAST-LINSENREINIGER DENON AMC-22 FÜR DIESES PRODUKT. SOLLTEN SIE DIES NICHT BEACHTEN, KÖNNTE DER LASERABTASTKOPF DIESES PRODUKTES BESCHÄDIGT WERDEN.

ATTENTION :

N'UTILISEZ PAS LE NETTOYEUR DE CAPTEUR D'OBJECTIF CD DENON AMC-22 POUR CE PRODUIT. CECI POURRAIT ENDOMMAGER LE CAPTEUR LASER DE CD DE CE PRODUIT.

PRECAUCIÓN:

NO UTILICE EL LIMPIADOR DE OBJETIVO DEL DETECTOR DE CD DEL DENON AMC-22 PARA ESTE PRODUCTO. ESTO PUEDE DAÑAR EL DETECTOR LASER DE ESTE PRODUCTO.

OPGELET:

GEBRUIK DE PICK-UPLENSREINIGER VAN DE DENON AMC-22 NIET VOOR DIT PRODUCT. DIT KAN DE LASER PICK-UP VAN DIT PRODUCT BESCHADIGEN.

FÖRSIKTIGT:

ANVÄND INTE LINSAVPUTSAREN FÖR DENON AMC-22:NS CD-PICKUP FÖR DENNA PRODUKT. DET KAN SKADA PRODUKTENS LASERPICKUP.



DN-S5000 Quick Start Guide

Track Change:	Turn the rotary knob (on the upper right side) to desired track.
Search/Scan:	Move the "Fast Search" lever to search forward or search back.
Skip Search:	Quickly shift and release the "Fast Search" lever to its end for 1-min hops.
Frame Search:	Turn the scratch mode knob to "Search" turn the top scratch disc until point is found, press main CUE to save your new point.
Scratch:	Insert Disc, turn scratch mode Knob to "MAIN", press lower left PLAY button, manipulate the top vinyl disc as desired.
Scratch Lever:	Select "Both" for natural scratching. Select "Fwd" to mute the reverse sound of audio.
Hot Disc:	During play mode, press and hold the "Eject" button for more than 1 sec, remove disc & insert new. Monitor, mix & play as normal.
Hot Starts:	Press the A1 or A2 button to set a cue point during play. Press the same button again to re-trigger.
Clear Hot Starts:	Press and hold the "FLIP" button corresponding to the same row for more than 1 sec.
Alpha Track:	During Main play, press the alpha mode button, select track, monitor & mix your Alpha track through the mixer.
Mirror Mix:	During Main play, press and hold the alpha mode button for more than 1 sec, press alpha play to start.
Pitch Range:	Press and hold the "Pitch" button for more than 1 sec, turn rotary knob to select pitch, ($\pm 4, 10, 16, 24, 100\%$) press enter to save your new setting.
Key Adjust:	Press the "Pitch" button until the orange "Key Adj." icon is shown above the pitch % in the display. Button Cycle; Pitch On -> Pitch & Key On -> All Off.
Brake/Echo:	Press the "Brake/Echo" button once to active "Brake", twice to activate "Echo", a third to turn all off. Button Cycle; Brake -> Echo -> All Off.
Dump/Reverse:	Press the "Dump/Rvs" button once to set "Dump", twice for "Rvs", a third to turn all off. Press the main PLAY/PAUSE to toggle on/off. Button Cycle; Dump -> Rvs -> All Off.

Details of X-EFFECT CONNECTION

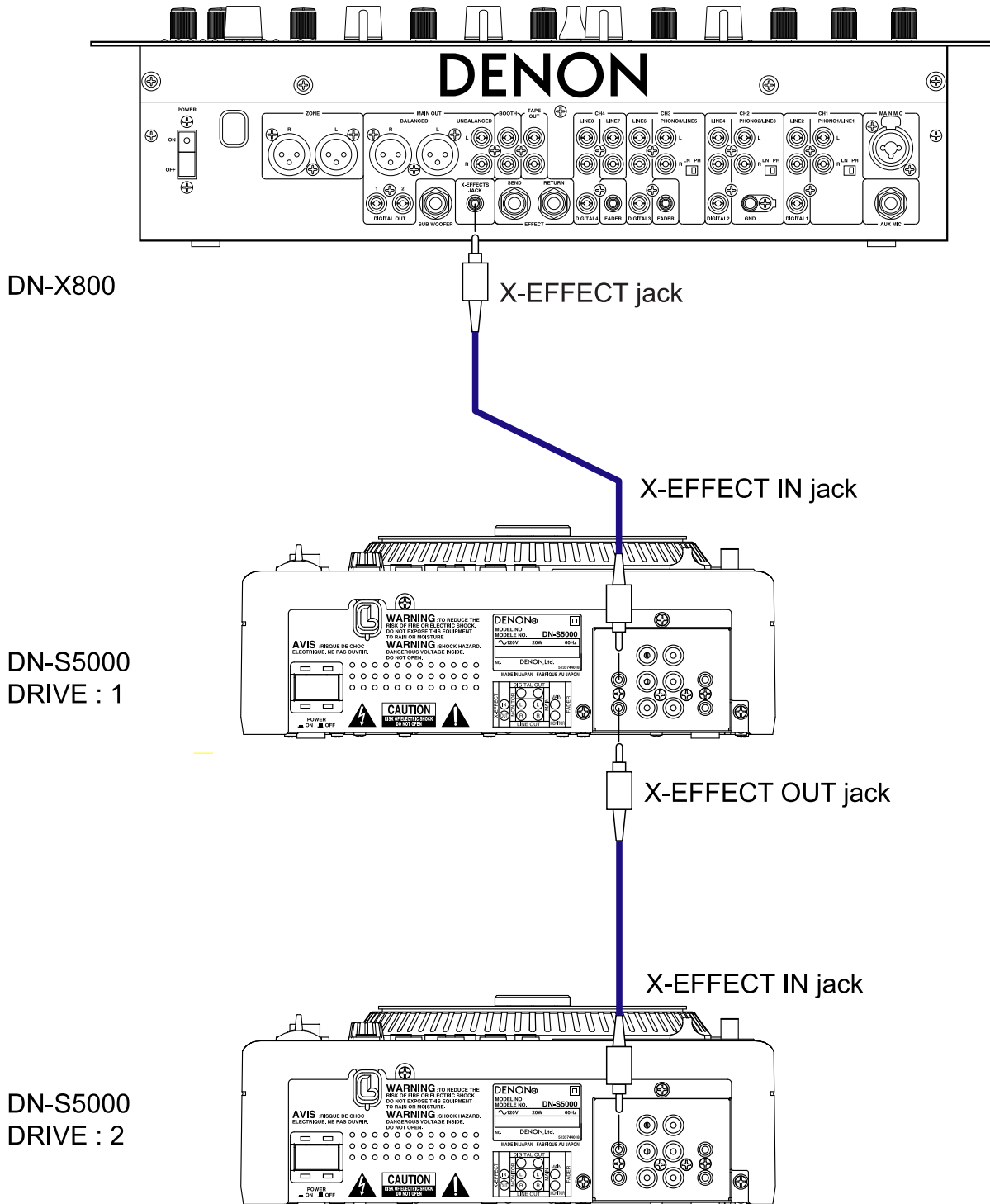

- TABLE OF CONTENTS -

<p>1 Main features6</p> <p>2 Connections/Installation7</p> <p>3 Part names and functions7 ~ 10</p> <p>4 Compact discs10</p> <p>5 Basic operation11</p> <p>6 Scratch.....12</p> <p>7 Playing the alpha track (Real time Sampler).....13, 14</p> <p>8 Alpha mode (Alpha-Track monitor)15</p> <p>9 Seamless loop/Hot start/ Stutter and Splice.....16, 17</p>	<p>10 A/B trim18</p> <p>11 A3/A4 for Sampler, 4 Hot Start, Alpha-track Hot Start19, 20</p> <p>12 Platter effect.....21</p> <p>13 Memo (Custom setting memory).....22</p> <p>14 Preset23</p> <p>15 Program/Random/Relay play/ Power on play.....24, 25</p> <p>16 Specifications26</p> <p>17 Replacing the belt.....26</p>
---	--

• ACCESSORIES

Check that the following parts are included in addition to the main unit:

<p>① Operating instructions1</p> <p>② Connection cords for signal output (RCA)2</p>	<p>③ Belt.....1</p> <p>④ Hexagon wrench.....1</p>
---	---

1 MAIN FEATURES

Congratulations on your new purchase of the DN-S5000. The DN-S5000 table top single CD player is equipped with a variety of advanced features, functions and rich performance for unlimited creativeness and showmanship.

Professional Structure and parts

1. Active Motor Platter (New)

When playback is started, the Platter turns in the same way as with an analog turntable.

The active motor Platter consists of the Motor-driven Platter, Slip Mat and Scratch Disc, so the beginnings of tracks can be found, the beat can be matched and scratching can be performed with the same feeling as an analog turntable.

2. Slot loading and Removable drive (New)

Our newly designed replaceable drive (Slot-in type) structure is geared for professionals who require virtually "zero down time". The heavy-duty drives are built with optimum parts to assure longevity.

3. Visible Displays

Visibility is greatly thanks to the large FL tube displays, backlit buttons and disc opening illumination, which comes in handy during low light environments.

4. Improved Controller Interface

Good feeling and operation thanks to a large 190mm Platter, SCRATCH Direction Select knob, SCRATCH Source Select knob, FAST SEARCH knob, TRACK/PARAMETERS knob, 100mm pitch slider and soft rubber buttons.

Features and Functions

The implementation of powerful DSP's and large memory capacity allows for many new controlling features such as:

1. SCRATCH (Improved)

Thanks to the active motor Platter, the Scratch sound is as good as with analog turntables.

Furthermore, the Main Track, α -Track and Samples can be selected as the Scratch sound source at the touch of a knob. The Scratch direction (both/forward) can also be switched at the touch of a knob, allowing for a variety of Scratch operations not possible with analog turntables.

2. HOT DISC (New)

Discs can be replaced while the sound is still playing (for up to 35 seconds). If the disc is replaced during the Seamless Loop mode (maximum 35 seconds between points A and B), the disc can be replaced without worrying about the time.

Thanks to the Alpha-Track and Hot Disc functions, sound can be played with the same feel as a dual CD player, even when using a single DN-S5000.

3. MIRROR MIX (New)

The Alpha-Track can be played with a delay of the specified beat or time after the Main Track.

Mirror Mixing is also possible in the RVS, dump and Scratch play modes, so a variety of sound effects can be achieved.

4. ALPHA-TRACK PLAY

This powerful function succeeded from our DN-D9000 dual CD player allows independent and

simultaneous playback of another track from the same disc, we call this the "Alpha-Track". The playing pitch and output level for the Alpha-Track can be independently adjusted.

5. **ALPHA-MODE**

The Alpha-Track output can be monitored through the ALPHA OUT RCA jacks separately, so you can play up to two tracks simultaneously through a mixer. This lets you switch smoothly from a "Live" playing track to the next track on the same disc in a single unit with no break in sound.

6. **HOT START and STUTTER**

The Hot Start function lets you start playback immediately from a set point decided by you. Up to four points can be set in the 4 Hot Start mode. The loaded Hot Starts can also be used to "Stutter" those points. When in Stutter mode, momentary audio is triggered according to the length of time of which these buttons are held down and released.

7. **SEAMLESS LOOP (Improved)**

With this function, any section on a disc can be played repeatedly between A & B points with no break in sound or limit in length. The DN-S5000 supports a total of four Seamless Loops in a single unit. The DN-S5000 also has a variety of looping functions.

8. **SPLICE**

This function removes unwanted sections of a track seamlessly such as; long vocal breaks found in dance mixes or explicit lyrics.

9. **SAMPLER**

Two on-board digital Samplers can record up to 15 seconds CD quality sound at 44.1kHz sampling frequency. You can seamlessly loop these samples or play them backwards (REVERSE). The pitch and output level of each sample can be adjusted independently. The B point can be easily set or changed exactly the same way as you would with the A-B Seamless Loop function.

10. **A/B TRIM and MOVE**

The A and B points for the Seamless Loop, Sampler loop and Splice points can easily be adjusted using the Scratch Disc. Trim and Move modes are available.

A-B TRIM: For adjusting the points while playing the live loop.

A/B MOVE: For moving the points using the manual search.

11. **PLATTER MODE (Improved)**

Analog turntable-like playback can be simulated using five Platter effects.

DRAG START: Simulates the dragging sound of a turntable's slow starting up from a stop mode. (Start-up time can be adjusted.)

BRAKE: Simulates a winding-down sound of a turntable coming to a full stop slowly. (Slowing-down time can be adjusted.)

TAIL ECHO: Adds an echo sound when playback is paused.

DUMP: Plays the sound backwards while continuing in a forward motion without losing "elapse time" when you return back to normal play.

RVS: (Reverse) Plays the sound backwards until you return to normal play.

12. **AUTO BPM COUNTER, BPM LOCK, MANUAL TAP, and MANUAL BPM INPUT (New)**

In addition to an Auto BPM counter and Manual Tap function, the DN-S5000 is also equipped with a Lock function for temporarily locking the Auto BPM counter and a Manual BPM Input function for inputting the BPM value directly by a Rotary knob, so the BPM setting can be made easily.

13. **MEMO**

Various settings such as Cue Points, Hot Starts, A-B Loops, A-B Splice, Pitch and Key Adjust can be saved to the internal non-volatile memory for later recall. Up to 5000 points are available (1 memory per track).

The memory function can also be used in the Alpha Mode and memory contents can be exchanged with another DN-S5000, DN-D9000 or DN-2600F.

14. **PITCH/KEY ADJUST**

PITCH: Playback speed is adjusted with PITCH slider. Adjustable pitch ranges are +/- 4, 10, 16, 24, 100% (selectable).

KEY ADJUST: Keeps the original key even if the pitch playing speed is changed with the PITCH slider.

15. **DIGITAL OUT (Improved)**

The digital output for Main and Alpha-Track provides a true 100% digital signal without any restrictions or limitations regardless of pitch change or mode setting.

16. **FADER START / X-EFFECT IN/OUT (New)**

The DN-S5000 FADER START and X-EFFECT controls are compatible with our DN-X800 mixer. Only Fader Start is compatible with the DN-X400 mixer. When two DN-S5000s are connected by X-EFFECT, it is possible to compare their memos.

17. **SHOCKPROOF MEMORY**

16 seconds of shock-proof memory guards against audible interruptions due to external mechanical shocks such as bumps or other hard vibrations, which is especially helpful for the mobile DJ as well as for nightclub-installed applications.

18. **PROGRAM/RANDOM/RELAY PLAY**

You can playback tracks in various modes with PROGRAM Play, RANDOM Play and RELAY Play modes.

19. **PRESETS**

It is possible to customise the machine to your preference by saving your favourite setting to internal memory. For items found in the presets, please see page 23.

20. **CD TEXT (New)**

2 CONNECTIONS/INSTALLATION

1. Turn off the POWER switch.
2. Connect the RCA pin cords between the DN-S5000 outputs and inputs of your mixer. Be sure MAIN OUTs are Main outputs and ALPHA OUTs are outputs of Alpha-Track sound.
3. If your mixer has Fader Start function such as our DENON DN-X800 or DN-X400, connect FADER 1, 2 jacks to the mixer using 3.5 mm stereo mini cord.
4. If you have a DENON DN-X800 mixer, you can use the X-Effect function to control the Hot Starts, Samplers and Brake from the crossfader to get wide variety of operation. You may also trigger the Alpha Track by connecting Fader Start 1, 2 to the DN-X800 mixer using the 3.5 mm stereo mini cords.

Fig. 1 : Fader start connections example 1

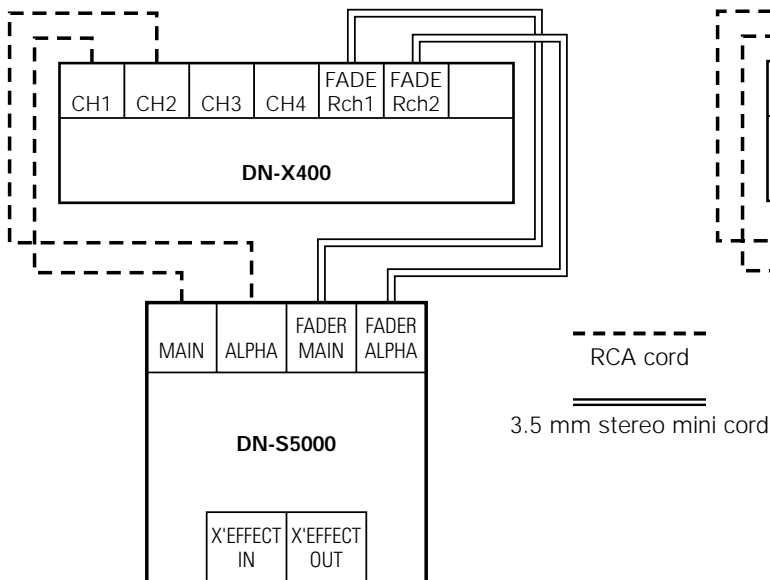
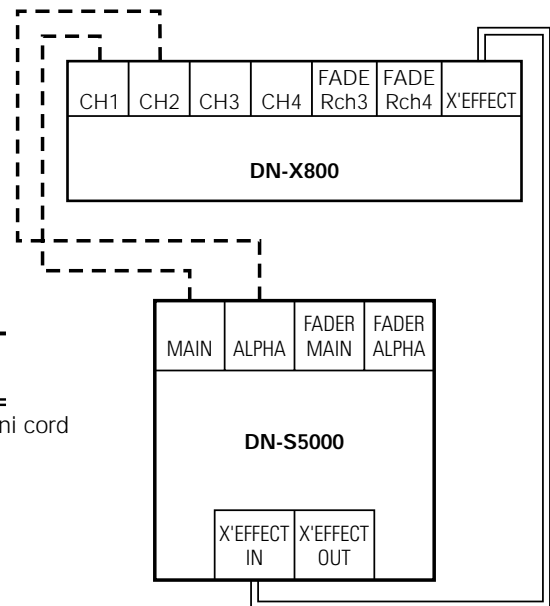

Fig. 2 : X-Effect connections example 1



- Fader start playback is possible with the Main and Alpha-Tracks.

- X-EFFECT playback is possible with the Main and Alpha-Tracks.

Fader start connections example 2

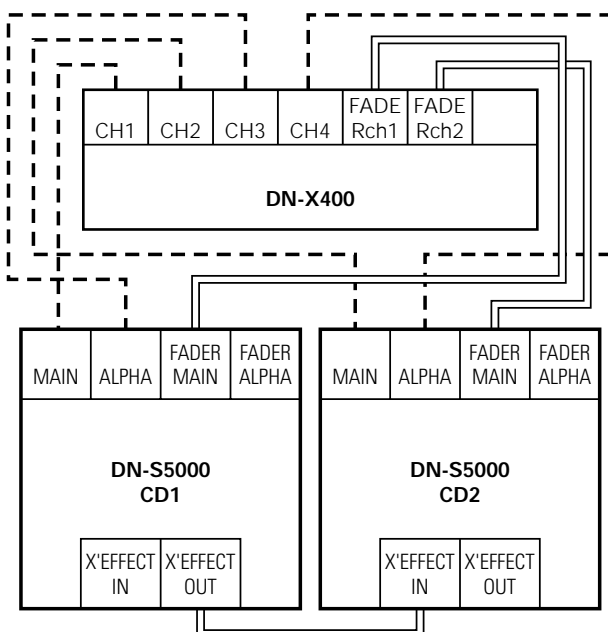

X-Effect connections example 2

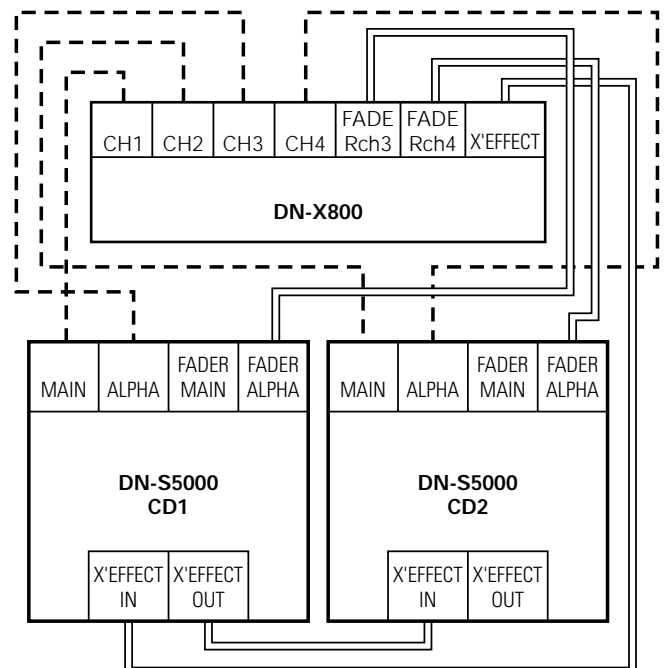

- Fader start playback is possible with the CD 1 Main Track and CD 2 Main Track.
- The memos of CD1 and CD2 can be compared when the CD players are connected by X-EFFECT.
- Relay play

- X-EFFECT playback is possible with the CD 1 Main Track and CD 2 Main Track.
- The memos of CD1 and CD2 can be compared when the CD players are connected by X-EFFECT.
- Fader start playback is possible with the Alpha-Tracks of CD1 and CD2.
- Relay play

3 PART NAMES AND FUNCTIONS

(1) Front panel

1 Disc loading slot

- Load the CD. Load the disc slowly, and release it once the DN-S5000 starts drawing the disc in.

CAUTIONS:

- Do not load discs when the power is turned off.
- Do not try to forcibly remove a disc once the DN-S5000 has started to draw it in.
- Do not load more than once disc at a time or insert anything other than discs. Otherwise loading mechanism may be damaged.

2 CD drive

- This Drive is field replaceable by you.
- Optional spare drive is sold separately.

(2) Rear panel

3 POWER button (ON OFF)

- Push this button to turn power on and off.

CAUTION:

- Do not turn off the power while a disc is loading or being ejected. Otherwise loading mechanism may be damaged.

4 X-EFFECT jacks (X-EFFECT IN/OUT)

- Connect this jack to the DENON mixer DN-X800 and DN-S5000 with 3.5 mm stereo mini cord.

5 Alpha analog output jacks (LINE OUT ALPHA)

- These are unbalanced RCA output jacks.
- Alpha-Track audio signals are output.

6 Main analog output jacks (LINE OUT MAIN)

- These are unbalanced RCA output jacks.
- Main audio signals outputs.

7 Fader start jacks (FADER MAIN, ALPHA)

- Use these when your mixer has Fader Start function with 3.5 mm stereo mini cord.

8 Digital output jacks (DIGITAL OUT MAIN, ALPHA)

- Main/Alpha Digital data is output from these jacks.
- Use 75 Ω /ohms pin cord for connections.
- We recommend you use braided wire type shielded cables.

(3) Top panel

CAUTION:

- Note that there are many buttons working two different function selected by short time pushing or long pushing (1second or more). The
 - mark indicates short time push function and
 - mark indicates long time push function.

9 Play/Pause button (▶||)

- This button will start or pause playback.
- Push once to start playback, once again to pause playback, and once more to resume playback.

10 DISC EJECT, ■ HOT DISC button

- **DISC EJECT:**
Eject disc with this button while button illumination light. Note that if illumination is off, you cannot eject disc.(Eject lock function)
- **HOT DISC:**
When the button is pressed and held in for more than 1 second during playback, the disc can be ejected.

11 CUE button

- Pushing this button in play mode will force the track back to the position which playback started. While in search mode, it makes new Cue point. (Cue)
- In Cue mode, by pushing the CUE button makes a Stutter sound from the Cue point. This is called Stutter play. (Stutter)

12 Platter/Scratch Disc

Use this for the manual search, Pitch Bend and Scratch operations.

- **Platter:**
The Platter turns when playback of the source selected in the Scratch mode (Main or Alpha-Track) starts.
- **Scratch Disc:**
When Scratch Disc is turned, Scratch playback of the source selected in the Scratch mode (Main, Alpha-Track or Sampler) starts.
NOTE: The Platter does not turn when the Scratch mode is set to the SAMPLER or the SEARCH mode. If "PLATTER off" is selected with the presettings, the Platter never turns, regardless of the Scratch mode.

CAUTIONS:

- Do not forcibly try to stop the Platter when it is turning. Otherwise Platter moving mechanism may be damaged.
- If a problem with Platter rotation arises when the Platter is turning, the Platter stops turning and the pause mode is set.

13 SCRATCH direction select knob

Select the Scratch play direction.

- **BOTH:**
When Scratch Disc is turned, Scratch sound is output in both directions.
- **FWD:**
When Scratch Disc is turned, Scratch sound is output in the forward direction only.

14 SCRATCH source select knob

Select the source for Scratch playback and the manual search/bend mode.

- **MAIN:**
Scratch Main Track sound
- **α TRACK:**
Scratch Alpha-Track sound
- **SAMP.:**
Scratch Sampler Track sound
- **SEARCH:**
When Scratch Disc is turned during playback, works as the pitch bend function.
When Scratch Disc is turned in the pause or standby mode, works as the manual search function. Manual search works and you can move point by one frame (1/75 second) with sound.

15 FLIP/CLR button

- **FLIP:**
Use this to select operating mode of A1 and A2 buttons, from Hot Start mode and Stutter mode. FLIP LED lights up in Hot Start mode.
- **A1, A2 CLR:**
If the A1 or A2 button is pushed while pushing the FLIP button, you can clear the selected A point.
By holding down just the FLIP button for more than 1 sec, you can clear A1 and A2 points all at once.

16 (SAMP) RVS/FLIP/CLR button

- **(SAMP)RVS:**
Use this to select the sample play direction forward and reverse. When select reverse RVS LED lights up.
- **FLIP:**
If in 4 Hot Start mode or Alpha-Track Hot Start mode, this button works as FLIP button for A3, A4. You can select Hot Start or Stutter mode. When Hot start mode is selected FLIP LED lights up.

- **A3, A4 CLR:**
If the A3 or A4 button is pushed while pushing the FLIP button, you can clear the selected A point.
By holding down just the FLIP button for more than 1 sec, you can clear A3 and A4 points all at once.

17 A1 button

18 A2 button

- Using these buttons you can create starting points for Hot Start, Seamless Loop, Stutter and Splice playback.
- The button illumination changes its colour to inform different modes.
Orange ..Hot Start mode
GreenAlpha-Track Hot Start mode
Yellow.....Splice mode

19 SAMP1/A3 button

20 SAMP2/A4 button

- **SAMP1/SAMP2:**
In the Sampler mode, push these buttons to record or play sound of Sampler 1 or 2.
- **A3, A4:**
When in the 4 Hot Start or Alpha-Track Hot Start modes, these act as A3 or A4 button. You can use these buttons for Hot Start, Seamless Loop and Stutter playback.
- These 2 buttons illumination colour changes in the different modes.
Orange ..4 Hot Start mode
GreenAlpha-Track Hot Start or Sampler mode

21 B button

- Use this to set the B point for A1 and A2 Seamless Loop and splice playback end.
- The B LED indicates conditions about B point.
B LED lit:
Already B point was set.
B LED flashing:
In Splice point setting mode

22 (SAMP) B, B button

- **(SAMP)B:**
In the Sampler mode, use this to set the Sampler loop B point.
- **B:**
In the 4 Hot Start or Alpha-Track Hot Start modes, use this to set the B point for A3 or A4 button Seamless Looping.

23 • A/B TRIM, – SPLICE button

- **A/B TRIM:**
With a short push of this button, the A and B point trim mode changes on and off while in PLAY or CUE mode.
- **SPLICE:**
When pushed for more than 1 sec , Splice point setting mode for A1 and A2 starts.

24 (SAMP) EXIT/RELOOP, EXIT/RELOOP button

- **(SAMP)EXIT/RELOOP:**
Use this to turn the Sampler Loop mode on and off. Also acts as EXIT/RELOOP button for Sampler Loop to exit or back again.
- **EXIT/RELOOP:**
In the 4 Hot Start or Alpha-Track Hot Start modes, use this to exit or back again Seamless Loop for A3 and A4.
- EXIT/RELOOP LED indicates conditions of loop.
EXIT/RELOOP LED lit:
Seamless Loop on or playing.
EXIT/RELOOP LED flashing:
Playback after exit loop.

25 EXIT/RELOOP button

- Use this to exit, back again to Seamless Loop playback for A1 and A2 with keeping all loop settings. You can add variety looping with this function.
- The LED indicates what's going on about looping.
EXIT/RELOOP LED lit:
Seamless Loop on or playing.
EXIT/RELOOP LED flashing:
Playback after exit loop.
- This button also switches repeat play modes on and off in Program, Random mode.

26 • A3/4, – PITCH/VOL button

- **A3/4:**
After a short push, A3, A4 button operating mode can be selected with the PARAMETERS knob from Sampler, 4 Hot Start, Alpha-Track Hot Start.
- **PITCH/VOL:**
After pushing for more than 1 sec, pitch and output level of Sampler, Alpha-Track playback can be adjusted with the PARAMETERS knob.

27 DISPLAY MAIN/ α (Alpha), – TITLE button

- **DISPLAY MAIN/ α (Alpha):**
A quick push will display changes between MAIN display and α TRACK display.
- **TITLE:**
When there is CD text data, the CD text data is displayed when the button is pressed for more than 1 second.
The display returns to normal after the CD text data is displayed.

28 • CONT./SINGLE, – RELAY button

- **CONT./SINGLE:**
Short pushing play ending mode between CONT (continue: play more tracks) and SINGLE (stop playing at current track played).
- **RELAY:**
You can turn on and off RELAY PLAY mode.
Relay playback is possible when two DN-S5000s are connected by X-EFFECT.

29 • TIME, – T.TIME button

- **TIME:**
A quick push will display mode changes between ELAPSED TIME and REMAIN TIME.
- **T.TIME:**
A long push, will display mode changes between TRACK TIME and DISC TIME.
- So, you can select display mode from four modes, TRACK ELAPSED, TRACK REMAIN, DISC ELAPSED and DISC REMAIN.

30 • MEMO, – PRESET (/ PROGRAM/RANDOM) button

- **MEMO:**
The memo mode starts when this button is pushed once in the Cue mode.
- **PRESET:**
When this button is pushed for more than 1 sec, the PRESET mode starts.
- **PROGRAM:**
When the Preset mode is selected, with a short push, you can make list of program play and turn on/off Program play mode using PARAMETERS knob.
- **RANDOM:**
When the Program mode is selected, with a short push, Random play mode can be turned on/off with PARAMETERS knob.

31 FAST SEARCH knob (◀◀ ▶▶)

- Fast-forward playback is selected when moved to the ▶▶ side, fast-reverse playback is selected when moved to the ◀◀ side.

32 α (Alpha) MODE, – MIRROR MIX button

- **α (Alpha) MODE:**
Use this to turn the Alpha-Mode on and off. The Alpha-Mode playback sound is outputted from the ALPHA OUT jacks in the Alpha-Mode.
- **MIRROR MIX:**
The Mirror Mix mode is selected when this button is pressed and held in for more than 1 second. When the button is pressed and held in for more than 1 second, the Mirror Mix mode is turned off.
In the Mirror Mix mode, the Alpha-Track is played with a delay of the specified beat or time after the Main Track.

33 α (Alpha) CUE/SAMP. STOP button

- **α (Alpha) CUE:**
Use this as CUE and STUTTER button in Alpha-Track.
This button lights up when the Alpha-CUE point is set.
- **SAMP. STOP:**
Push while Sampler playback, Sampler playback stops.

34 TRACK/PARAMETERS knob

- **TRACK:**
When PARAMETERS LED is on, turn this knob to select tracks.
By pushing this knob down while turning, the tracks will change 10 at a time.
- **PARAMETERS:**
When the PARAMETER LED is flashing, turn this knob to select and change the parameter for items found in the Platter effects, Program, Memo, and Preset data, etc.

35 α (Alpha) track Play/Pause button (▶||)

- When this button is pushed while in the Cue or Pause mode, the Alpha-Track playback starts. By pushing it once again will Pause the Alpha-Track.
- It is necessary to make Cue point for the Alpha-Track before starting Alpha-Track playback.

36 α (Alpha) PITCH BEND – button

37 α (Alpha) PITCH BEND + button

- Pushing these buttons will change Alpha-Track playing speed temporary.
- While pushing α (Alpha) PITCH BEND + button playing speed increases and speed decreases while pushing α (Alpha) PITCH BEND – button.
- When release button, playing speed returns to the previous speed.
- **α (Alpha) CUE-CLR:**
If the α (Alpha) CUE button is pushed while pushing the α (Alpha) PITCH BEND – button, the Alpha-Cue point is cleared.

38 TAP, • LOCK, – AUTO/INPUT BPM button

- **TAP:**
When you push this button repeatedly, the Auto mode turns off and starts measuring your Beats Per Minute (BPM) by tapping.
- **LOCK:**
When this button is pressed once while the auto BPM counter is operating, the data measured by the auto BPM counter is locked.
- **AUTO:**
When pushing the TAP button for 1 second, activates AUTO BPM mode.
The measured BPM is displayed in the character section of the display.
- **INPUT BPM :**
When the TAP button is pressed and held in for more than 2 seconds, the BPM input mode is set and the BPM value can be input directly with the PARAMETERS knob. When the button is pressed again, the BPM input mode is turned off.

NOTE:

If you select a new track, AUTO BPM mode turns on automatically.

39 PITCH BEND – button

40 PITCH BEND + button

- Pushing these buttons will change main playing speed temporary.
- While pushing PITCH BEND + button playing speed increases and speed decreases while pushing PITCH BEND – button.
- When release button, playing speed returns to the previous speed.

41 Pitch Slider

- Use this slider to adjust playing speed.
- The playing speed decreases when slide upwards and increases downwards.

42 • PITCH/KEY, – RANGE button

- With this button you can select PITCH and KEY ADJUST mode. Mode changes Pitch on, Key Adjust on and both off cyclically. PITCH LED indicates in Pitch mode and KEY ADJUST indicator lights up in Key Adjust mode.
- **RANGE:**
Push this button for more than 1 sec to select the pitch range.

43 • DUMP/RVS, – SOURCE button

- **DUMP/RVS:**
Push this button a short time to select the effect function from RVS and DUMP.
- **SOURCE:**
When this button is pressed and held in for more than 1 second, the source for which the Platter effect function is to be used (Main, Alpha-Track or Main and Alpha-Track) can be selected with the PARAMETERS knob.

44 • BRAKE/ECHO, – TIME button

- **BRAKE/ECHO:**
Push this button a short time to select the effect function from BRAKE and ECHO.
- **TIME:**
If pushed for more than 1 sec, you can select time for BRAKE or ECHO with PARAMETERS.

45 • DRAG-S, – TIME button

- **DRAG-S:**
Push this button a short time to set the DRAG-S.
- **TIME:**
If pushed for more than 1 sec, you can select time for DRAG-S with PARAMETERS.

(4) Display

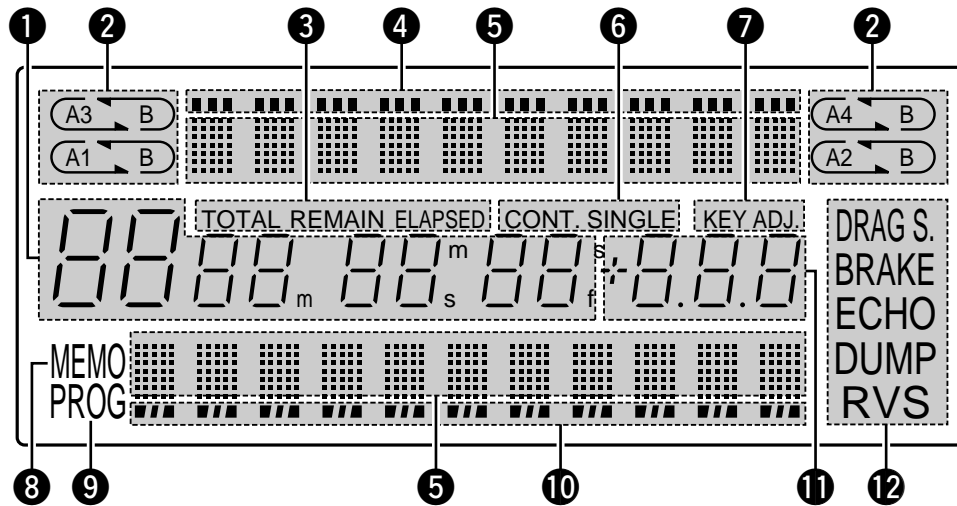

1 Track, minute, second and frame displays

- These displays indicate current position information.

2 Loop mode indicators

- DN-S5000 has Loop mode indicators consist of four sets of A (A1, A2, A3, A4), B and two arrows. A and B marks indicate A and B points are exist.
- Two arrows indicate loop setting mode as follow.

Example: A1 B

or Left arrow only on:

Hot Start mode

Both arrows on:

Seamless Loop mode

, Both arrows flashing:

Seamless Loop Playing

, Left arrow on, right flashing:

Exit play from Seamless Loop

3 Time mode indicators

- When the TIME/T.TIME button is pushed, the Time mode indicator switches as follows:
ELAPSED:

Track's elapsed time is displayed.

REMAIN:

Track's remaining time is displayed.

TOTAL + ELAPSED:

The total elapsed time of disc or programmed track is displayed.

TOTAL + REMAIN:

The total remaining time of disc or programmed track is displayed.

4 Parameter indicators (upper 30 dots)

- Upper 30 dots on display indicate parameter, data setting for Effector visually.

5 Character display

- You can select mode or function using PARAMETERS knob following the short message which is displayed on the character display part.
- The character display indicates the operation, mode name, data, etc., and displays such guide messages as "Yes/Push_PM" means if "YES", push PARAMETERS knob. The display indicates \gg and \sphericalangle marks sometime, note that \gg mark says you to turn PARAMETERS knob and \sphericalangle marks says to push PARAMETERS knob.
- The PARAMETERS LED flashes when you can use PARAMETER knob, otherwise this knob used for Track Selection.

6 Play mode indicators

- When SINGLE indicator lights up, playback will finish at end of current track.
- When CONT. indicator lights up, playback continues.

7 KEY ADJ. indicator

- KEY ADJ. sign appears in display when in the Key Adjust mode.

8 MEMO indicator

- MEMO sign appears in display when there is a memory setting for the currently playing track or the track at which the standby mode is currently set.

9 PROG indicator

- This indicator lights up when program data has been set and when program data is stored in the memory.

10 Play Position indicators (Play position indicator lower 33)

- **Play position indicator:**
The 33 white dots indicate where is playing visually in a track in the normal play. The 11 Orange dots indicate play position in the reverse play mode.
- **End of Message:**
When the time remaining to the end of the track is less than the specified time, the EOM (End Of Message) play position indicator flashes along with the remaining time, notifying of the track end.
 - * The EOM time can be set with the presets.

11 Pitch display

- This numeric indicator display the playback speed (pitch).

12 PLATTER MODE indicators

- There are signs of Platter Effects DRAG S., BRAKE, ECHO, DUMP, RVS. These signs light up when mode is on.

4 COMPACT DISCS

1. Precautions on handling compact discs

- Do not allow fingerprints, oil or dust to get on the surface of the disc.
If the disc is dirty, wipe it off with a soft dry cloth.
- Do not use benzene, thinner, water, record spray, electrostatic-proof chemicals, or silicone-treated cloths to clean discs.
- Always handle discs carefully to prevent damaging the surface; in particular when removing a disc from its case or returning it.
- Do not bend the disc.
- Do not apply heat.
- Do not enlarge the hole in the center of the disc.
- Do not write on the label (printed side) with a hard-tipped implement such as a pencil or ball point pen.
- Condensation will form if a disc is brought into a warm area from a colder one, such as outdoors in winter. Do not attempt to dry the disc with a hair dryer, etc.

2. Precautions on storage

- After playing a disc, always unload it from the player.
- Always store the disc in the jewel case to protect from dirt or damage.
- Do not place discs in the following areas:
 - (1) Areas exposed to direct sunlight for a considerable time.
 - (2) Areas subject to accumulation of dust or high humidity.
 - (3) Areas affected by heat from indoor heaters, etc.

5 BASIC OPERATION

Play and pause

- Each push of the 9 PLAY/PAUSE (▶||) button switches between playback and pause. PLAY/PAUSE (▶||) button illuminates solid green during playback and flashed in pause.
- When the 9 PLAY/PAUSE (▶||) button is pushed during play, the DN-S5000 pauses playback at that point. Push PLAY/PAUSE (▶||) button once again and playback resumes.
- When the Scratch mode is set to MAIN, the Platter turns when the Main Track is played. When the rotation of Scratch Disc is stopped by pressing with the finger, the pause mode is set, and when the finger is released playback resumes.

Play and Cue

- When the 11 CUE button is pushed during playback, the track stops and returns to the position that current playback started (Cue point) and prepares for next playback. This function is called Back-Cue. With Back-Cue function, you can start from exactly same position. The CUE button illuminates solid red when DN-S5000 is ready to start playback.
- You can set and change Cue point as follows.
 - When you started playback.
 - Track select finished.
 - manual search.

Select the track

- Turn the 34 TRACK knob.
- By pushing 34 TRACK knob down while turning, the tracks will change 10 at a time.

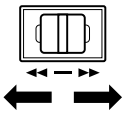
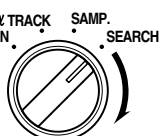
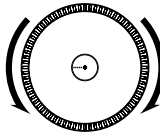
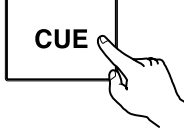

Move the Cue point

- If you would not like to start playback from beginning of the track, you need to move Cue Point using fast Search and manual search function.

1	You can move to the approximate playback start position by fast-forwarding and fast-reversing using the 31 FAST SEARCH knob. 
2	Turn the 14 SCRATCH source select knob to select Scratch Disc to search mode. The all Scratch mode LEDs will turn off. 
3	Turn the 12 Scratch Disc to change Cue point. You can hear the short sound of the current Cue point.  When Scratch Disc is turned in the pause, standby or frame repeat mode, works as the manual search function.
4	After you found your preferred Cue point, push the 11 CUE button then new Cue point is set. 

Adjusting the pitch

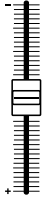
- With Pitch slider you can adjust the playback speed (Pitch).
- If you would not change key of sound, use the Key Adjust function.

1	Push the 42 ● PITCH/KEY button to PITCH LED lights up.  • PITCH → KEY (key adjust) → OFF
2	 Pitch decreases Move the 41 Pitch slider to adjust the pitch. The current pitch setting is displayed on the display. Pitch increases
3	DN-S5000 has five pitch ranges, 4%, 10%, 16%, 24% and 100%. When the 42 - RANGE button is pushed for more than 1 sec, the pitch range can be selected with the PARAMETERS knob. 

Pitch Bend

- With PITCH BEND function you can change pitch temporary. DN-S5000 has three ways for this function PITCH BEND buttons and Scratch Disc.

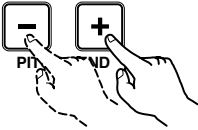
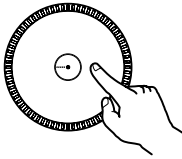
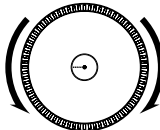
1	<p>[PITCH BEND +/- buttons]</p> <ul style="list-style-type: none"> • Push the 39 PITCH BEND - or 40 + button for momentary change of pitch.  <p>While holding these buttons down, the pitch continues to change up to the limitation.</p> <ul style="list-style-type: none"> • After releasing the PITCH BEND buttons, playback pitch returns to slider setting.
2	<p>When the Scratch source is set to MAIN and the Platter is turning, playback of the Main source can be slowed temporarily by lightly pressing 12 Scratch Disc or PLATTER.</p>  <p>In addition, playback can be quickened temporarily by pushing Scratch Disc or PLATTER in the direction in which the Platter is turning.</p>
3	<p>[Scratch Disc]</p> <ul style="list-style-type: none"> • When the Scratch mode is set to SEARCH, the playback speed can be changed by turning 12 Scratch Disc during playback.  <ul style="list-style-type: none"> • The pitch increases gradually when the Scratch Disc is turned clockwise and decreases when turned counterclockwise. • When you stop turning the Scratch Disc, the playing speed returns to the previous pitch.

BPM

- Normally the BPM for the currently playing track is measured and displayed on the auto BPM counter.

NOTE:

For some tracks the BPM cannot be measured properly.

BPM LOCK:

When this button is pressed once while the auto BPM counter is operating, the data measured by the auto BPM counter is locked.

TAP:

When you push this button repeatedly, the Auto mode turns off and starts measuring your Beats Per Minute (BPM) by tapping.

INPUT BPM:

When the TAP button is pressed and held in for more than 2 seconds, the BPM input mode is set and the BPM value can be input directly with the PARAMETERS knob. When the button is pressed again, the BPM input mode is turned off.

NOTE:

If you select a new track, AUTO BPM mode turns on automatically.

Main Hot Disc

- The disc can be ejected while still Main Track playing.

1	<p>Data loading</p> <p>When the 10 DISC EJECT button is pressed for more than 1 second and held in while the Main Track is playing, up to 35 seconds of subsequent data can be read. (at 0% pitch)</p> <ul style="list-style-type: none"> If a Seamless Loop of within 35 seconds is playing, loop playback continues. <p>NOTE: The Hot Disc function cannot be used when both the Main Track and Alpha-Track are playing.</p> <p>When the Hot Disc function is started, the Sampler data and points A and B aside from the points for the currently playing loop are cleared.</p>
2	<p>Eject</p> <ul style="list-style-type: none"> Once data loading is completed, the disc is ejected. The operating buttons switch to the Alpha-Track controls. (▶ → α▶ , CUE → α CUE, A1 → A3, A2 → A4, and Loop control buttons.)
3	<p>Disc loading and Cue search</p> <ul style="list-style-type: none"> Load a new disc. Operate as usual, and cue to the beginning of a track or match the beat. <p>At this time, the disc's playback signals are output from the ALPHA OUTPUT terminals.</p>



4	<p>Change output</p> <p>Once cueing is completed, stop playback, and when the 32 α MODE button is pressed output of the disc's playback signals switches from the ALPHA OUT to the MAIN OUT terminals.</p> <ul style="list-style-type: none"> Start playback from the disc and stop Hot Disc playback.
5	<p>Hot Disc clear</p> <p>When the 33 α CUE button is pressed while pressing the 36 α PITCH BEND - button, the Hot Disc mode is turned off and the player is set back to the normal mode.</p> <p>NOTE: The α MODE button does not function before the Hot Disc data is cleared.</p>

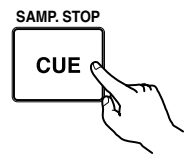
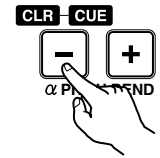
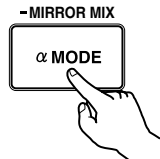

6 SCRATCH

You can Scratch in CD or Sampler mode. Also you can select the Scratch sound direction to (turn direction of Scratch Disc), both and forward. These selections give you variety of Scratch effects.

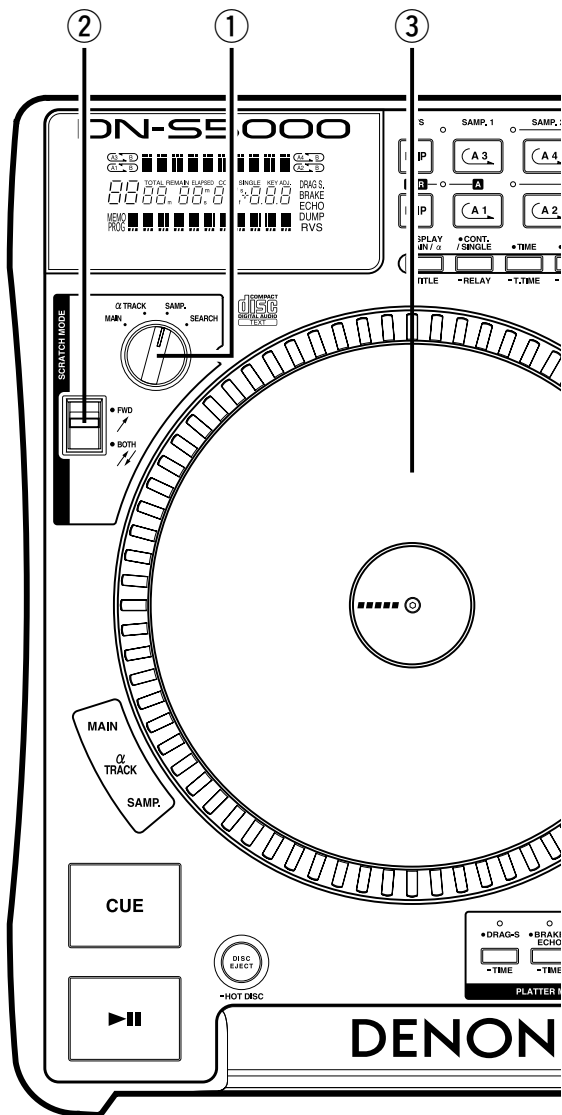

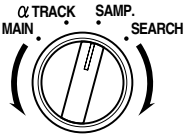
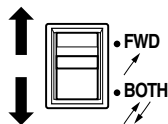
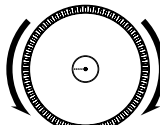
<p>1</p>	<p>Select Scratch source</p> <p>① Select the source to be scratched using the SCRATCH source select knob.</p>  <ul style="list-style-type: none"> • If scratching is possible, the LED for the selected source flashes. • If scratching is not possible immediately, because for example the Sampler or Alpha-Track settings have not been made, the LED for the selected source lights without flashing.
<p>2</p>	<p>Select Scratch direction</p> <p>② Select the direction for scratching using the SCRATCH direction select knob.</p> 
<p>3</p>	<p>[Scratch Disc]</p> <p>③ When MAIN is selected as the Scratch mode and Scratch Disc is turned by hand, the Main Track is scratched.</p> <p>When Alpha-Track is selected as the Scratch mode and Scratch Disc is turned by hand, the Alpha-Track is scratched.</p> <p>When SAMPLER is selected as the Scratch mode and Scratch Disc is turned by hand, the sample is scratched.</p> 

7 PLAYING THE ALPHA TRACK (Real Time Sampler)

- The Alpha-Track function lets you play one more track (the Alpha-Track) while playing the Main Track.
- The Alpha-Track's pitch and sound level can be adjusted.
- You can switch output channel of Alpha-Track sounds from MAIN OUT (default) or ALPHA OUT with the presets.
- You can use this function like a Sampler from Alpha-Cue point (Real time Sampler). When the ALPHA OUT is selected, DN-S5000 can playback up to two songs simultaneously.
- When playing the Alpha-Track, scratching, Hot Starting, Seamless Looping (Alpha-Track and Hot Start modes) and Hot Disc are possible in the same way as with the Main Track.

NOTE: The Sampler and Alpha-Track functions cannot be used simultaneously.

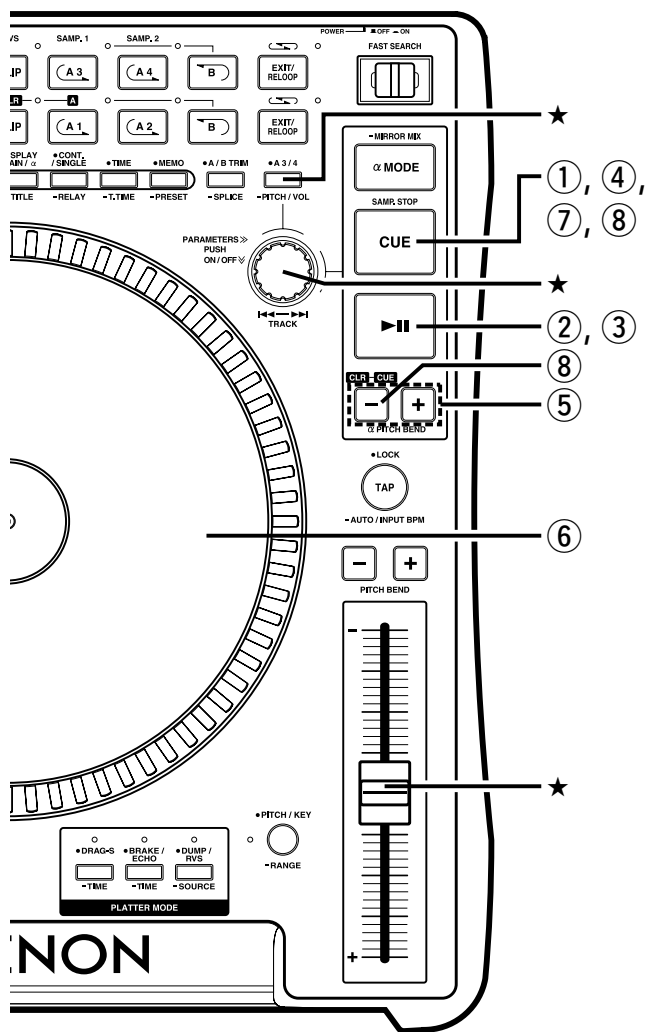

Enter Alpha-Track mode

- When Main Track is in the standby or playing, push the α CUE button to set the Alpha-Cue point. The α CUE button lights up red.

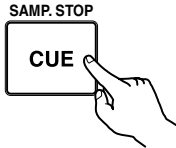
 - When Alpha-Cue is set during standby at the Main Track, playback of the Main Track starts.
 - The display can be switched between the Main Track and Alpha-Track using the α DISPLAY button. When "Alpha-Track display" is selected, "PARAMETERS" is set to the alpha-track pitch input mode.

Start Alpha-Track playback

- Push the α play/pause button to start Alpha-Track playback. When playback starts, the α play/pause button lights up green.

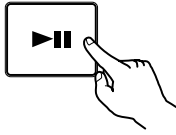
 - When the scratch mode is set for the Alpha-Track, the Platter turns when the Alpha-Track is played. The pause mode is set when the rotation of Scratch Disc is stopped by pressing with the finger while the Platter is turning, and playback resumes when the finger is released.

Pause Alpha-Track playback

- During Alpha-Track playback, push the α play/pause button to pause playback. When the pause mode is set, the α play/pause button starts flashing.

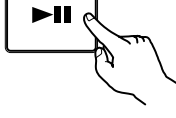

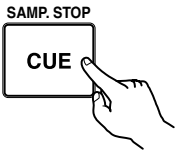
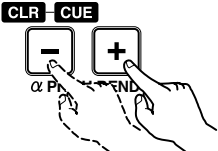
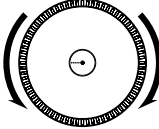
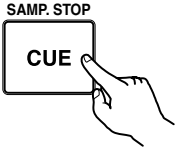
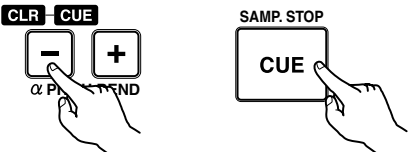

4	<p>Back Cue Alpha-Track playback</p> <p>④ In the Alpha-Track playback or pause mode, push the α CUE button to Back-Cue. The α CUE button lights up red.</p>  <p>NOTE: That the Alpha-Cue point is not changed automatically with start playback.</p>
5-1	<p>Alpha-Track pitch bend 1 [α (Alpha) PITCH BEND +/- buttons]</p> <p>⑤ Push the α PITCH BEND - or + button for momentary change of pitch.</p>  <p>While holding these buttons down, the pitch continues to change up to the limitation.</p> <ul style="list-style-type: none"> • After releasing the α PITCH BEND buttons, playback pitch returns to slider setting.
5-2	<p>Alpha-Track pitch bend 2 [Scratch Disc]</p> <p>⑥ When the Scratch source is set to Alpha-Track and the Platter is turning, playback of the Alpha-Track can be slowed temporarily by lightly pressing Scratch Disc or Platter. In addition, playback can be quickened temporarily by pushing Scratch Disc or Platter in the direction in which the Platter is turning.</p> 
6	<p>Stutter play the Alpha-Track</p> <p>⑦ In the Alpha-Track standby mode, push the α CUE button to start stuttering.</p> 
7	<p>Clear Alpha-Track</p> <p>⑧ While pushing the α PITCH BEND - button, push the α CUE button to clear the Alpha-Cue point.</p> 

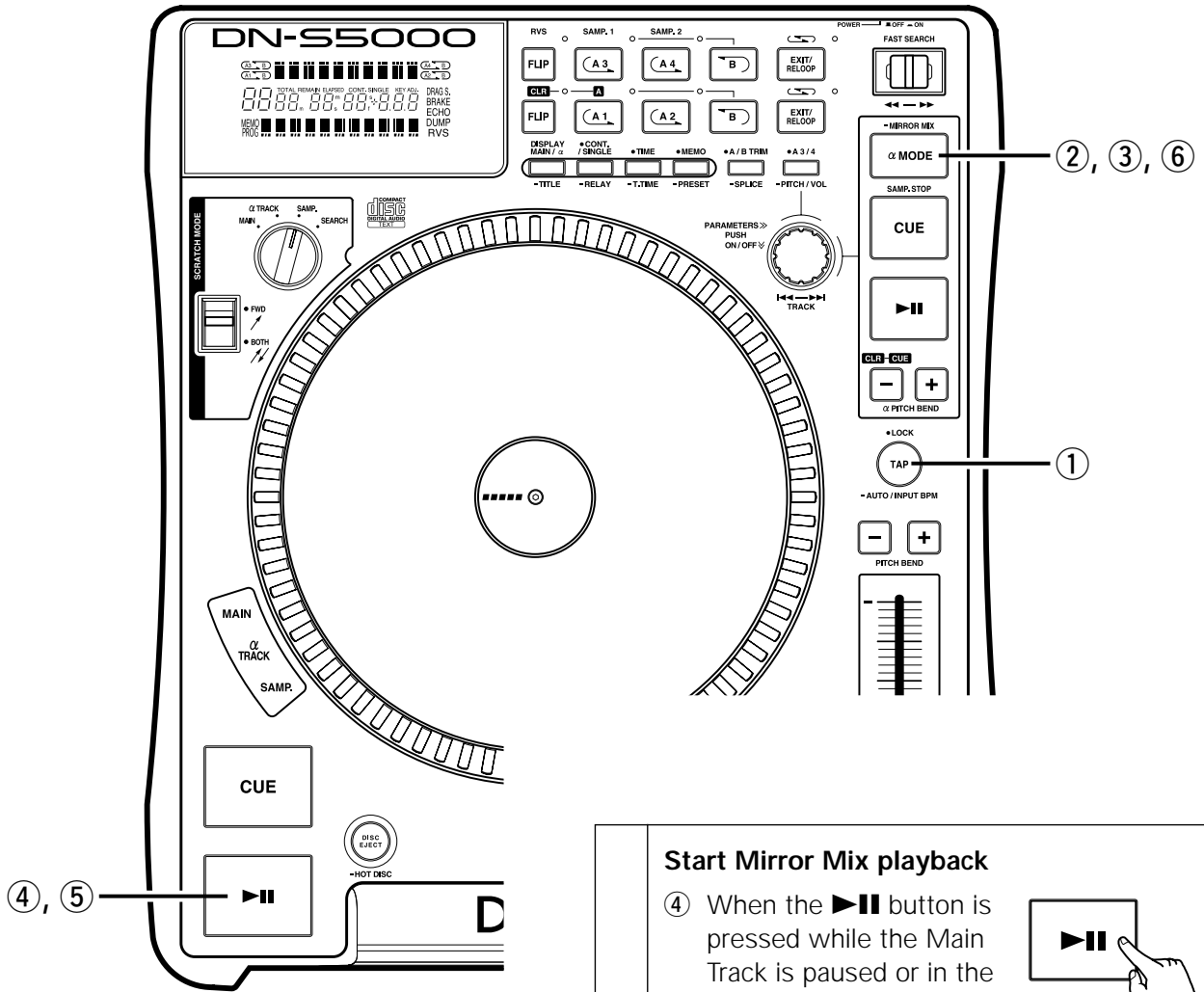

8	<p>Adjust sound level and pitch</p> <p>The Alpha-Track and Sampler playback sound level and pitch can be adjustable.</p> <ul style="list-style-type: none"> ★ (1) Push the PITCH/VOL button for more than 1 sec, the pitch input mode is selected, PARAMETERS LED flashes and the current settings are displayed on the character display. (2) Push the PITCH/VOL button again to selected the sound level output mode. (3) Start Alpha-Track or Sampler playback. (4) Turning the PARAMETERS knob can change the sound level or pitch. <ul style="list-style-type: none"> * When pushing down and turning the PARAMETERS knob, you can change the pitch range 10 times faster. (5) Push the PITCH/VOL button again to turn the playing parameter mode off. <p>Unless you adjust Alpha-Track pitch separately, the Alpha-Track's pitch will be the same as your Main Track. In this case, pitch of both Main Track and Alpha-Track changes together when you move the main Pitch Slider</p>
---	---

Mirror Mix

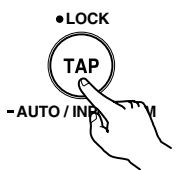
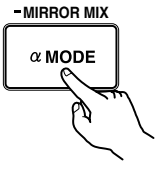
- The Alpha-Track can be played with a delay of the specified beat or time after the Main Track.

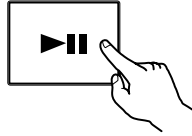
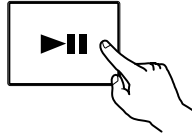

1	<p>Set BPM</p> <p>① The BPM for Main Track playback can be set with either the AUTO BPM counter, TAP button or BPM INPUT button.</p> 
2	<p>Enter Mirror Mix mode</p> <p>② The Mirror Mix mode is set when the MIRROR MIX button is pressed and held in for more than 1 second.</p> 
3	<p>Set the Mirror Mix parameter</p> <p>③ When the MIRROR MIX button is pressed again (short press), the delay beat time can be set with the PARAMETERS knob.</p> <ul style="list-style-type: none"> When the Mirror Mix mode is set during playback, Alpha-Track playback is paused. 

4	<p>Start Mirror Mix playback</p> <p>④ When the ► button is pressed while the Main Track is paused or in the standby mode, Mirror Mixing starts.</p> <ul style="list-style-type: none"> When the α ► button is pressed while the Main Track is playing, Mirror Mixing resumes. 
5	<p>Pause Mirror Mix playback</p> <p>⑤ When the ► button is pressed during Mirror Mixing, Mirror Mixing pauses.</p> <ul style="list-style-type: none"> The ► button flashes. <p>When the α ► button is pressed during Mirror Mixing, playback of the Alpha-Track only pauses.</p> <ul style="list-style-type: none"> The α ► button flashes. 
6	<p>Cancel Mirror Mix mode</p> <p>⑥ The Mirror Mixing mode is turned off when the MIRROR MIX button is pressed and held in for more than 1 second.</p> 

Alpha Track Hot Disc

- The disc can be ejected while still Alpha-Track playing.

1	<p>Data loading</p> <p>When the 10 DISC EJECT button is pressed and held in for more than 1 second while the Alpha-Track is playing, playback continues and the subsequent data is read for a maximum of 35 seconds. (at 0% pitch)</p> <ul style="list-style-type: none"> If a Seamless Loop of within 35 seconds is playing, loop playback continues. <p>NOTE: The Hot Disc function cannot be used when both the Main Track and Alpha-Track are playing.</p> <p>When the Hot Disc function is started, the Sampler data and points A and B aside from the points for the currently playing loop are cleared.</p>
2	<p>Eject</p> <p>Once data loading is completed, the disc is ejected.</p>
3	<p>Disc loading and Cue search</p> <p>Load a new disc.</p> <ul style="list-style-type: none"> Operate as usual, and cue to the beginning of a track or match the beat. When at this time the Alpha-Track signals are being output from the MAIN OUT terminals, the disc's playback signals are output from the ALPHA OUT terminals, and when the Alpha-Track signals are being output from the ALPHA OUT terminals, the disc's playback signals are output from the MAIN OUT terminals. The α MODE button flashes when the disc's playback signals are being output from the ALPHA OUT terminals.



4	<p>Change output</p> <p>Once cueing is completed, stop playback, and when the 32 α MODE button is pressed while it is flashing, output of the disc's playback signals switches from the MONITOR OUT to the MAIN OUT terminals.</p> <ul style="list-style-type: none"> Start playback from the disc and stop Hot Disc playback.
5	<p>Hot Disc clear</p> <p>When the 33 α CUE button is pressed while pressing the 36 α PITCH BEND - button, the Hot Disc mode is turned off and the player is set back to the normal mode.</p> <p>NOTE: The α MODE button does not function before the Hot Disc data is cleared.</p>

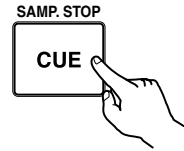
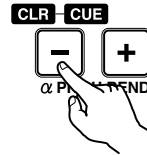
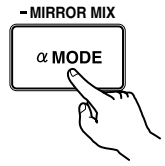

8 ALPHA MODE (Alpha-Track Monitor)

This function lets you play the Alpha-Track from ALPHA OUT while playing the Main Track. Using this function, you can prepare the next song on same CD before the end of your first track. While in Alpha-Mode, Alpha-Track's output can be monitored through your mixers headphone.

Therefore, you can switch between the Alpha-Track and Main Track at any time, so two tracks on the same disc can be played continuously with no break in the sound.

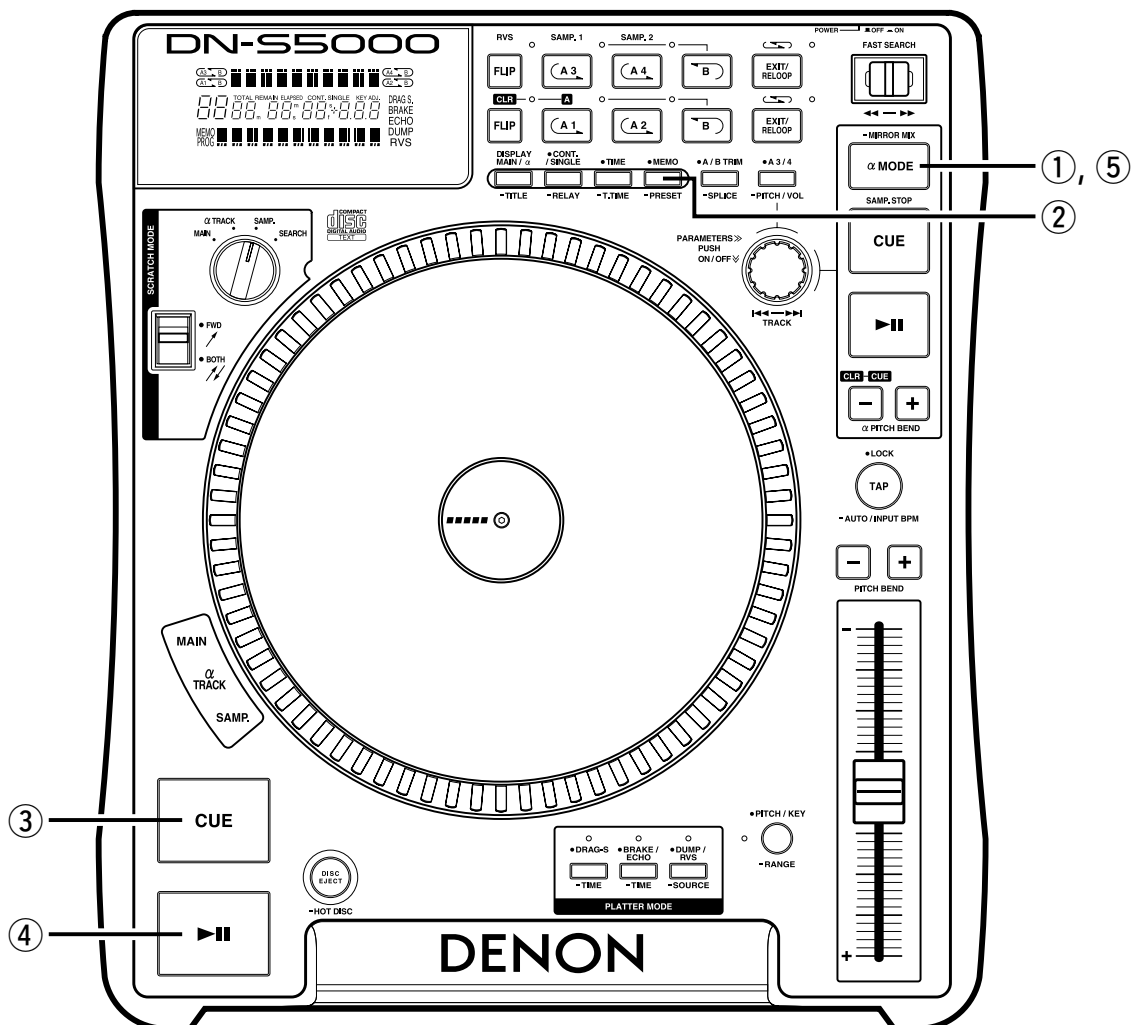

Enter Alpha-Mode

- ① Push the α MODE button to enter Alpha Mode.
 - When alpha-cue is not set, alpha-cue is set at the beginning of the Main Track.

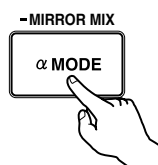

NOTE:

Before entering the Alpha-Mode, Samplers 1 and 2 (A3, A4 buttons) must be in the STOP mode otherwise the DN-S5000 will not accept the ALPHA-MODE command.

- * In the Alpha-Mode, illumination of α MODE button flashes.

Monitor the Alpha-Track

- You can execute many functions almost same as for the Main Track except, Program, Random. Without these functions you can prepare preferred sound and mixing point.
- In Alpha-Track mode, the display information is dominated by Alpha-Track.

* Memo Call

- ② If the Hot Start, Seamless Loop and other data for the track to be used next is stored in the memory, the settings for the track to be played can be made easily using the memo call function.

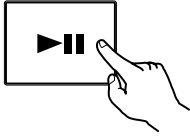
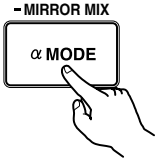

3	<p>Switching Alpha-Track and Main Track</p> <ul style="list-style-type: none"> • After you prepared your Alpha-Track, you can switch the sound between Alpha-Track and Main Track. <p>③ When your Main Track is Cued in Alpha-Mode, CUE button illumination flashes rapidly. At this time you can switch between Alpha-Cue point and main Cue point, then CUE button stops flashing and waits for your next command.</p> <p>④ When Main Track is playing and then Alpha-Mode + Alpha-Track is selected, the main ► button illumination flashes rapidly. At this time you can switch (slam-mix) to force the "MAIN OUT" to stop and the Alpha-Track to start by simply pushing the main ► button.</p>  <p>The sound from Alpha-Cue point is routed to MAIN OUT, then ► button stops flashing.</p> <p>* After Alpha-Track changed to Main Track, Alpha-Mode ends automatically and α MODE button illumination turns off. You can repeat the cycle again.</p>
4	<p>Pitch after switching</p> <ul style="list-style-type: none"> • Pitch of Alpha-Track can be changed separately from the Main Track. This causes the playback pitch to be different from the Pitch Slider setting after switching to Alpha-Track because the Pitch Slider was set originally for your Main Track. • In this case, PITCH LED flashes to warn that the Pitch Slider setting is different. Only until the position of the Pitch Slider matches its correct pitch of your Alpha-Track will the PITCH LED stop flashing and start changing with the Pitch Slider.
5	<p>Exit from Alpha-Mode</p> <p>⑤ You can exit from Alpha-Mode with push α MODE button.</p> 
6	<p>Hot Start, Sampler</p> <ul style="list-style-type: none"> • Hot Start and Sampler setting with A1, A2, A3, A4 are available as Hot Start in Alpha-Mode.

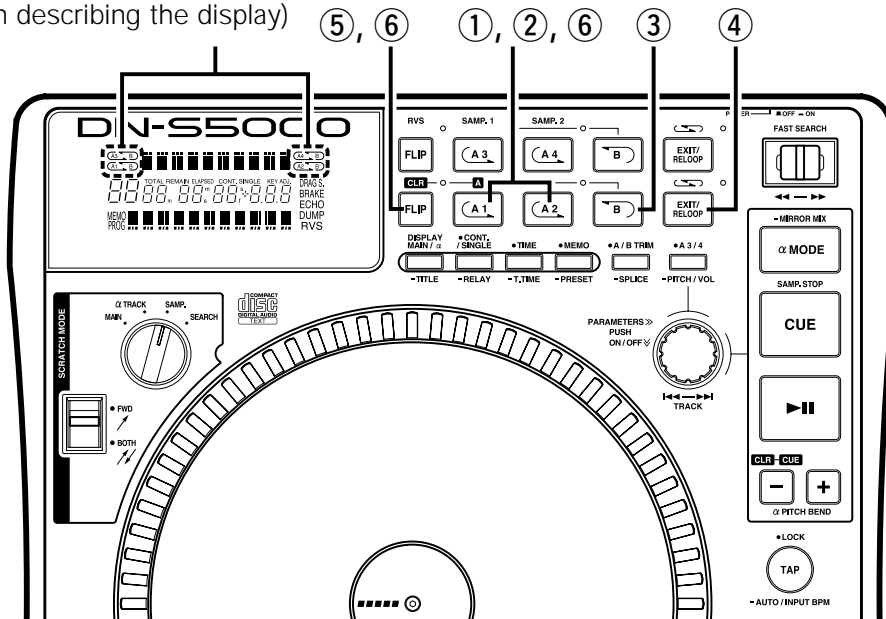

9 SEAMLESS LOOP/HOT START/STUTTER AND SPLICE

Seamless Loop/Hot Start/Stutter (A1, A2 buttons)

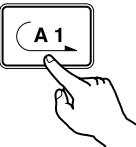
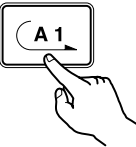
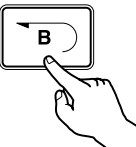
Operation display (refer to the section describing the display)

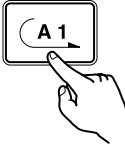

<p>1</p>	<p>Setting the A point (loading the Hot Start data)</p> <p>① Push the A1 or A2 button to set the A point and Hot Start data loading starts.</p> <ul style="list-style-type: none"> • A1 and A2 buttons can be used separately for each Hot Start. • When an A point is set, the corresponding A button and FLIP LED light and that button is set to the Hot Start mode. • The BPM is set independently for each Hot Start. 	<p>3-2</p> <ul style="list-style-type: none"> • If the B button is pushed during Seamless Loop playback or after EXIT playback, the B point moves to the point at which the button was pushed. • When the B point is set, the B and LOOP LEDs light.
<p>2</p>	<p>Starts Hot Start</p> <p>② When A1 or A2 button is pushed, Hot Start playback starts from the corresponding A point.</p> 	<p>4</p> <p>Playing Seamless Loops</p> <ul style="list-style-type: none"> • When the B point for A1 is detected after playback started from A1 point, playback returns to A1 point with seamless. While A1 to B looping, B point for A2 ignored. • When the B point for A2 is detected after playback started from A2 point, playback returns to A2 point with seamless. While A2 to B looping, B point for A1 ignored.
<p>3-1</p>	<p>Setting the B point for Seamless Loop</p> <p>③ When the B button is pushed after setting the A point or after starting Hot start playback, the B point is set and Seamless Loop playback starts from the A point.</p> <ul style="list-style-type: none"> • The B button works with respect to the A point operated before the B button was pushed. 	<p>5</p> <p>Exit/Reloop</p> <p>④ In Seamless Loop playback, you can force exit from or return in the loop.</p>  <p>EXIT: While the Seamless Loop playback, push the EXIT/RELOOP button to exit from loop. DN-S5000 continues playback after the B point.</p> <p>RELOOP: When the EXIT/RELOOP button is pushed after exit the loop, Seamless Loop playback resumes from the A point.</p>

6	<p>Stutter</p> <ul style="list-style-type: none">• A1 and A2 points can be also used for Stutter playback. <p>⑤ To enable stutter playback, push FLIP button for A1/A2 buttons, then FLIP LED turns off.</p> <p>Press the FLIP button to switch between the Hot Start/Seamless Loop and Stutter modes.</p> 
7	<p>Clear the A1/A2 point</p> <p>⑥ While pressing the FLIP/(CLR) button, push the A1 or A2 button to clear the corresponding A and B points.</p> <p>Or push the FLIP button for more than 1 sec to clear both A1 and A2 points at once.</p>  

Splice

- Use this function to skip a section between A and B points. The A point is the point from which jumping starts, the B point the point at which jumping ends.
- The A1 and A2 Hot Starts and Stutter functions cannot be used if both Splice points are set in the Splice mode.

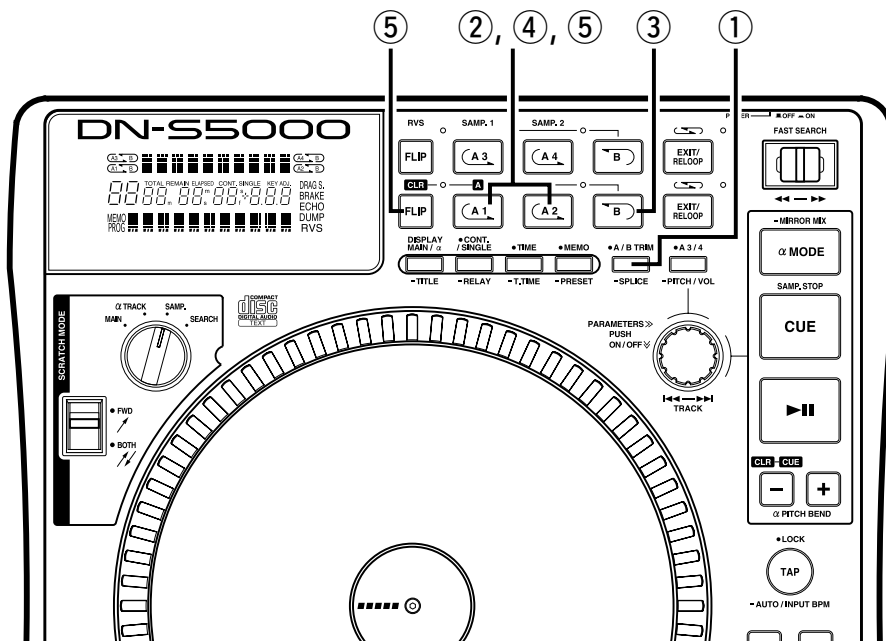

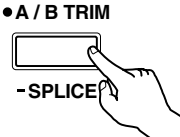
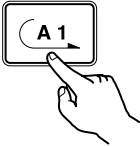
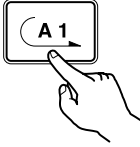
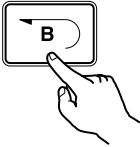
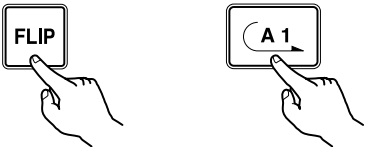
<p>1</p>	<p>Splice point setting mode</p> <p>① Push the SPLICE button for more than 1 sec to enable setting Splice point using A1, A2 and B buttons.</p> <ul style="list-style-type: none"> • The A button illumination flashes when the Splice mode is set. • The Splice point setting cannot be set for the A point at which Hot Start data is already loaded. 	<p>4</p> <p>Start splice playback</p> <p>Start playback from any point before point A. When point A is reached, the section from point A to point B is jumped seamlessly and playback continues.</p>
<p>2</p>	<p>Set splice start point A</p> <p>② After starting playback, push the A1 or A2 button. The corresponding A button lights up and that point is set as splice start point A, and B LED start flashing.</p> 	<p>5</p> <p>Temporarily turning off the splice playback</p> <p>④ When the corresponding A button is pushed after setting splice points A and B, the A button illumination turns off and the Splice play mode is temporarily turned off.</p> <ul style="list-style-type: none"> • Push the corresponding A button again to resume splice playback. 
<p>3</p>	<p>Set splice end point B</p> <p>③ After setting splice start point A, push the B button. The B LED lights up and that point is set as splice end point B.</p> 	<p>6</p> <p>Clearing the splice points</p> <p>⑤ While pressing the FLIP/(CLR) button, push the corresponding A button to clear splice points A and B.</p>  <ul style="list-style-type: none"> • When the splice points are cleared, the A button is set back to the Hot Start mode.

10 A/B TRIM

- The Seamless Loop, Sampler loop and splice A and B points can be fine-adjusted using Scratch Disc.
- There are two ways for doing this.
 - A-B Trim: Trim the points during loop playback as a rehearsal.
 - A/B Move: Move the points using the fast search or manual search. A/B Move can not be used with Sampler loop.

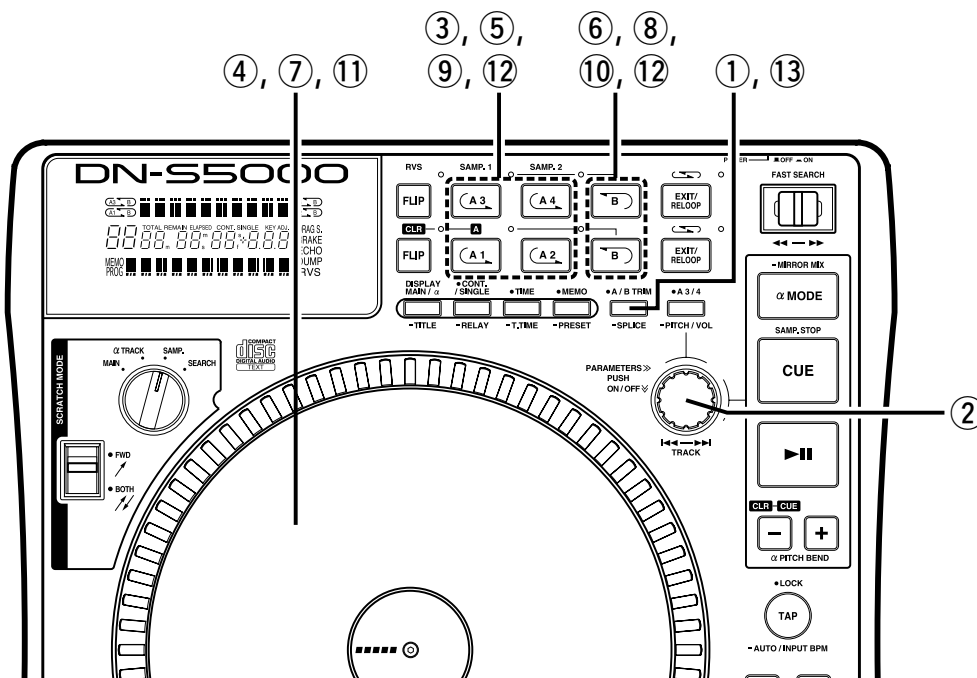

A/B Trim

<p>1</p>	<p>Select A-B trim mode</p> <p>First select whether to adjust the A and B points using the A-B trim mode or the A/B move mode.</p> <p>① Push the A/B TRIM button to set the A and B point position adjustment mode.</p> <p>② Now turn the PARAMETERS knob to select the A-B Trim or the A/B Move.</p>	<p>Trim A point</p> <p>④ Turn the Scratch Disc to move the A point 1 frame at a time.</p> <ul style="list-style-type: none"> • Range for trimming A point is limited as follows. <ul style="list-style-type: none"> A point for Loop: ±30 frames from the original A point. (However, when the A point was loaded from the standby mode, the A point cannot be moved backwards. So, use A/B Move function) A point for Splice: Between the beginning of the disc and 5 frames before B point. A point for Sampler: Between the original A point and 5 frames before B point.
<p>2</p>	<p>Select A point (in A-B Trim)</p> <p>③ Select the A-B Trim and push the corresponding A button for the loop to be trimmed. The A button illumination flashes and loop playback starts.</p> <ul style="list-style-type: none"> • In the splice trim mode, total 6 seconds of spliced section (started from 2 seconds before A point to 4 seconds after the B point) is played. 	<p>Save the A point</p> <p>⑤ Push the A button again to save new A point, and the unit automatically exit from the A-B Trim mode.</p>

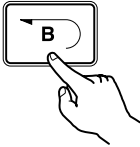
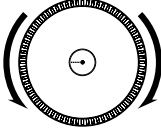
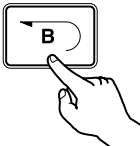
5	<p>Select B point (in A-B Trim)</p> <p>⑥ Select the A-B Trim mode and to select the B point, push the B button after selecting the A point. Then push the B button. The B LED flashes and the B point trim become enable.</p> 
6	<p>Trim B point</p> <p>⑦ Turn Scratch Disc to move the B point 1 frame at a time.</p>  <ul style="list-style-type: none"> • Range for trimming B point is limited as follows. <ul style="list-style-type: none"> B point for Loop: Between 5 frames after A point and disc end. B point for Splice: ±30 frames from the original B point. (However, when the B point was loaded from the standby mode, the B point cannot be moved backwards. So, use A/B Move function) B point for Sampler: Between 5 frames after A point and Sampler end.
7	<p>Save the B point</p> <p>⑧ Push the B button again to save new B point, and the unit automatically exit from finish the A-B Trim mode.</p> 

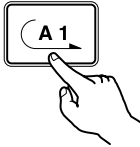
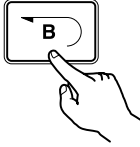
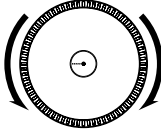
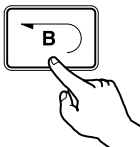
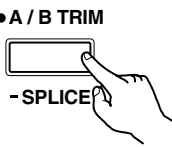
A/B move	
8	<p>Select A and B points</p> <p>⑨ Select or the A/B Move and push the A button for the A point you want to move. The standby mode is set at the A point and the A button illumination flashes.</p>  <p>⑩ To select the B point, push the B button after selecting the A point.</p>  <ul style="list-style-type: none"> • The B LED flashes. The Selected B point is used for the A1 or A2 point that was first selected.
9	<p>Move A or B points</p> <p>⑪ Turn the Scratch Disc to move the selected point using the manual search function.</p>  <ul style="list-style-type: none"> • Range for moving A point is limited as follows. <ul style="list-style-type: none"> A point for Loop: Between the beginning of the disc and 5 frames before B point. A point for Splice: Between the beginning of the disc and 5 frames before B point • Range for moving B point is limited as follows. <ul style="list-style-type: none"> B point for Loop: Between 5 frames after A point and disc end B point for Splice: Between 5 frames after A point and disc end
10	<p>Save the A or B points</p> <p>⑫ Push the A1/A2 or B button again. The LED stops flashing and the A1/A2 or B point is saved, and the unit automatically exit from the A/B Move mode.</p> 
11	<p>Cancel the A-B Trim or A/B Move</p> <p>⑬ Push the A/B TRIM button to cancel the mode.</p> 

11 A3/A4 FOR SAMPLER, 4 HOT START, ALPHA-TRACK HOT START

The buttons of A3, A4 and corresponding FLIP, B and EXIT/RELOOP are used for Sampler, 4 Hot Start and Alpha-Track Hot Start functions.

A3/A4 mode

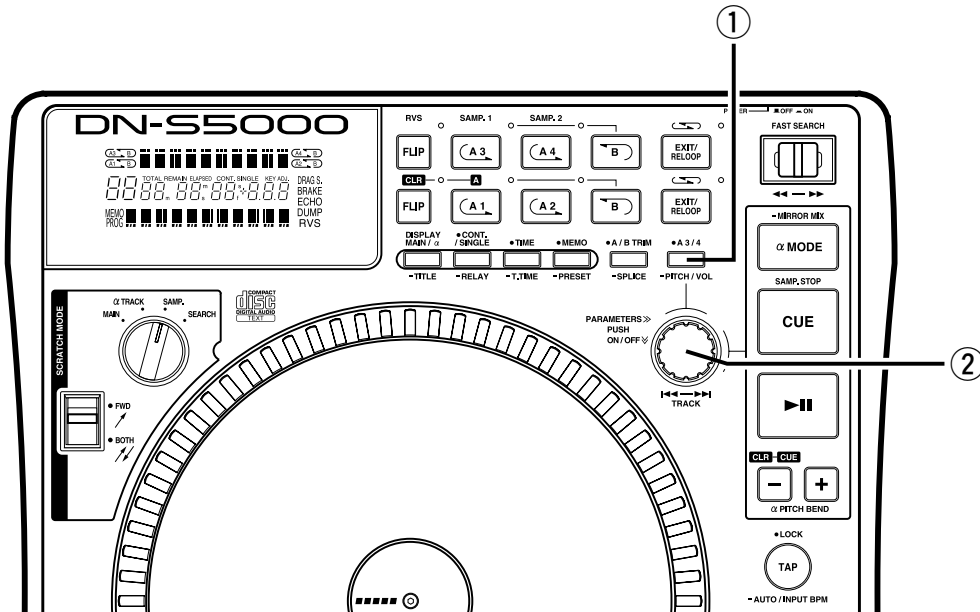

Select A3/A4 Mode

The A3 and A4 buttons can be used for one of the three modes described below.

- Sampler mode
- 4 Hot Start mode (A1, A2, A3 and A4)
- Alpha-Track Hot Start mode

① When the ● A 3/4 button is pushed, the operating mode can be selected with the

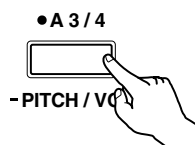

PARAMETERS knob. The PARAMETERS LED flashes and the A3/A4 mode is displayed on the character display.

② Turn the PARAMETERS knob and select the A3/A4 button mode, then push the PARAMETERS knob to set.

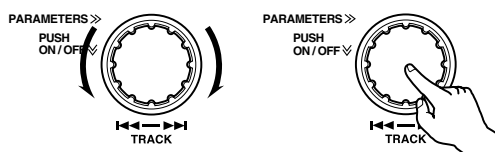

Sampler mode:

The A3 and A4 buttons light up in green.

- In Sampler mode, A3 button used for Sampler1 and A4 buttons are used for Sampler2.
- The sampled data is stored in the memory, even when the mode is changed.

4 Hot Start mode:

The A3 and A4 buttons light up in orange.

- Like the A1 and A2 buttons, the A3 and A4 buttons are also used for Hot Start, Stutter and Seamless loop playback. Then total 4 Hot Start points can be set, one each at buttons A1, A2, A3 and A4.
- The A3 and A4 points set in the 4 Hot Start mode can be used in Alpha-Track Hot Start mode as well.

Alpha-Track Hot Start mode:



The A3 and A4 buttons light in green.



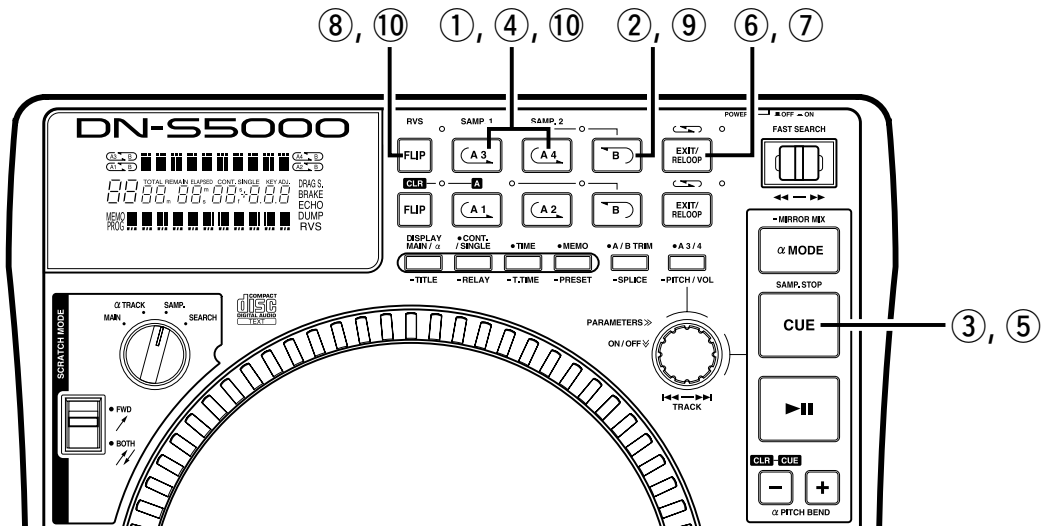

- Like the A1 and A2 buttons, the A3 and A4 buttons are also used for Hot Start, Stutter and Seamless loop playback. However, A3 and A4 Hot Start is played for the Alpha-Track.
- The A3 and A4 points set in the Alpha-Track Hot Start mode can be used in the 4 Hot Start mode as well.

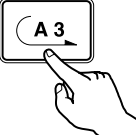
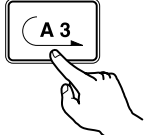
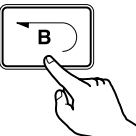
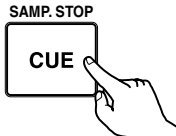
Sampler

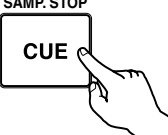
DN-S5000 has two Samplers of 15 seconds length. These Samplers are also used in looping playback.

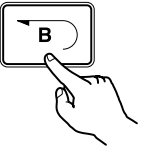

1	<p>Record in Sampler</p> <p>① When the SAMP button (SAMP1 (A3) or SAMP2 (A4)) is pushed in the standby or playing, the sound from A3 or A4 point is recorded to Sampler memory up to 15 seconds.</p> <ul style="list-style-type: none"> The SAMP1 or SAMP2 button is flashing while recording. When the recording is completed, the button turns off and the corresponding SAMP B LED lights up. 	<p>Play Sampler sound</p> <p>④ Playback of the Sampler sound starts when the SAMP button is pushed after recording has stopped.</p> <ul style="list-style-type: none"> Sampler playback continues in looping. With setting B point, playback loop between A and B point. Without B point setting Sampler loops whole recorded length (about 15 seconds). <p>NOTE: It is not possible to play Sampler1 and Sampler2 at the same time.</p> 
2	<p>Setting B point</p> <p>② When the B button is pushed during Sampler recording, the Sampler Loop B point is set and the loop mode turns on.</p> <ul style="list-style-type: none"> Recording continues for approximately 15 seconds without stopping after set B point. If the B point is not set, recording end point set as B point automatically. Also EXIT/RELOOP LED light to indicates Sampler Loop mode is set automatically. 	<p>⑤ To stop the Sampler sound push STOP (α CUE) button.</p>  <p>Select Sampler Loop mode</p> <p>You can select loop mode for Sampler when Sampler playback stop.</p> <p>Loop (default): Sampler playback continues with looping. (EXIT/RELOOP LED stays lit)</p> <p>Exit: Sampler playback continues over B point up to recording length. (EXIT/RELOOP LED flashes)</p> <p>Single: Sampler playback stops at B point. (EXIT/RELOOP LED turned off)</p> <p>⑥ To select loop mode, push EXIT/RELOOP button after recording and before playing.</p> 
3	<p>Stop recording</p> <p>③ To stop recording before recording finish automatically with memory full, push the STOP (α CUE) button.</p> <ul style="list-style-type: none"> The EXIT/RELOOP LED light to indicates Sampler Loop mode is set automatically. 	

6	<p>Exit and Reloop</p> <p>⑦ The EXIT/RELOOP button can be used same as Seamless Loop function.</p>	
7	<p>Reverse Play</p> <p>⑧ You can play Sampler sound in reverse with push RVS (FLIP) button. In reverse play mode RVS LED lights up.</p> <ul style="list-style-type: none"> Reverse playback will start with next playback starting after reverse mode turned on. 	
8	<p>Moving Sampler B point</p> <p>⑨ When the B button is pushed during Sampler playback, the B point moves to the point at which the button was pushed, and loop playback from point A starts.</p>	
9	<p>Setting the Sampler volume and pitch</p> <ul style="list-style-type: none"> The sound level (volume) and pitch can be set individually for Sampler1 and 2. See [7] - step 8 "Adjust sound level and pitch". 	
10	<p>Clearing the Sampler data</p> <p>⑩ While pressing the (RVS)/FLIP/(CLR) button, push the SAMP button (SAMP1 or SAMP2) to clear the Sampler.</p> <ul style="list-style-type: none"> By pushing the (RVS)/FLIP/(CLR) button for approx. 1 sec, you can clear both Samplers 1 and 2. 	

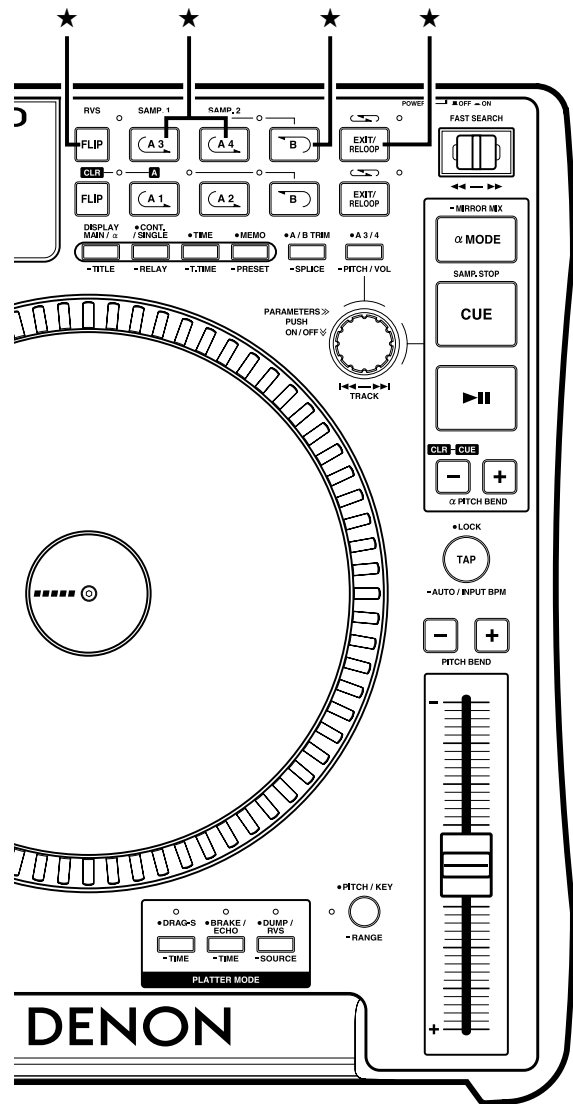

Hot start mode

Like with buttons A1 and A2, operation is performed using the (RVS)/FLIP/(CLR), A3, A4 and EXIT/RELOOP buttons. Operation is same as Hot Start with A1, A2 buttons. See page 16 for details.

Alpha-Track Hot Start mode

Like with buttons A1 and A2, operation is performed using the (RVS)/FLIP/(CLR), A3, A4 and EXIT/RELOOP buttons. (Refer to page 16.)

12 PLATTER EFFECT

This function is available for the Main Track and Alpha-Track.

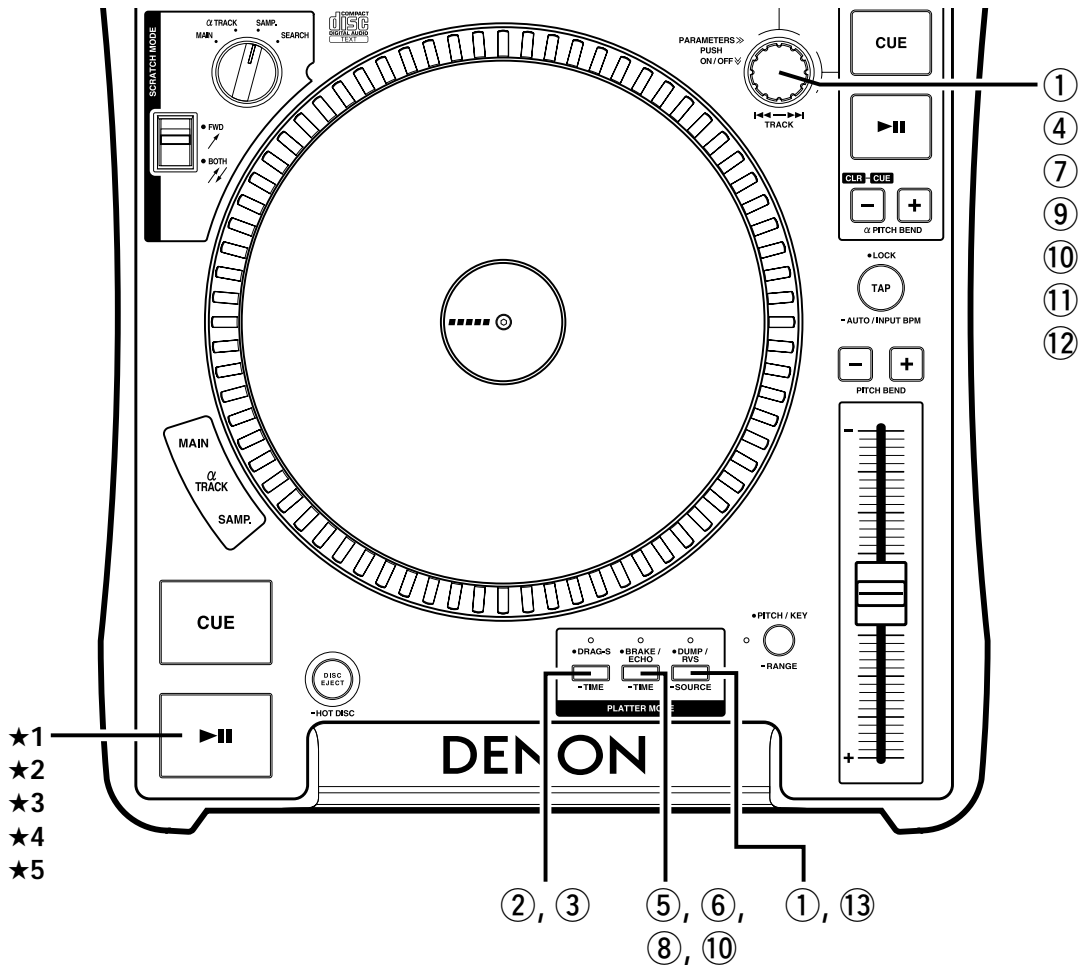

Select the Platter Effect Source

- When the SOURCE button is pressed and held in for more than 1 second, the source for which the Platter effect function is to be used can be selected with the PARAMETERS knob.

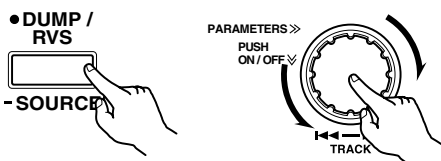

1 MAIN:

The Platter effect function only affects the Main Track.

α TRACK:

The Platter effect function only affects the Alpha-Track.

MAIN/α T:

The Platter effect function affects both the Main and Alpha-Track.

NOTE: The echo function cannot be used for the Main and Alpha-Tracks simultaneously.

DRAG-S (DRAG START):

Simulates the dragging sound of a belt drive turntable starting up from a stop mode.

2-1

- The DRAG-S function can be turned on and off by pressing the DRAG-S button.





DRAG-S TIME:

When the DRAG-S turn on, the PARAMETERS LED flashes and parameter are displayed. If you use with default settings, there is a 4 second time out of inactivity for the DRAG-S button once selected and PARAMETERS knob if adjusted. After 4 seconds, and exits out of the DRAG-S menu.

2-2

- Or when the TIME (DRAG-S) button is pressed and held in for more than 1 second, the DRAG-S time selection mode is set.

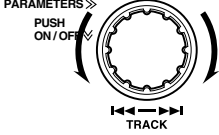

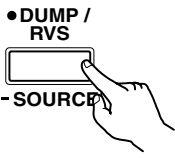
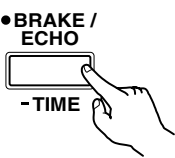
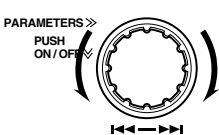
2-2	<p>④ The DRAG-S time can be selected with the PARAMETERS knob.</p>  <ul style="list-style-type: none"> When the PARAMETERS knob is pressed, the time is entered and the DRAG-S time selection mode is cancelled. <p>★1 The DRAG-S is activated when playback is started with the ► button.</p>	<p>ECHO TIME:</p> <p>⑧ Or when the TIME (BRAKE/ECHO) button is pressed and held in for more than 1 second while ECHO is selected, the mode for selecting the number of echo feedback times is set.</p> <p>⑨ The time of ECHO can be selected with the PARAMETERS knob.</p> <p>⑩ When the TIME (BRAKE/ECHO) button is pressed again (short press), the echo delay time can be selected with the PARAMETERS knob.</p> <p>⑪ The delay time of ECHO can be selected with the PARAMETERS knob.</p> <p>⑫ When the PARAMETERS knob is pressed, the data is entered and the echo time setting mode is cancelled.</p> <p>★3 The ECHO is activated when the ► button is pushed during playback.</p>
3-1	<p>BRAKE/ECHO</p> <p>BRAKE: Simulates a winding-down sound of a vinyl turntable coming to a full stop slowly.</p> <p>ECHO (TAIL ECHO): Adds a echo sound when playback stops.</p> <p>⑤ The mode switches in the following order each time the DRAG-S button is pressed: BRAKE → ECHO → off.</p> 	<p>DUMP/RVS</p> <p>⑬ The mode switches in the following order each time the DUMP/RVS button is pressed: DUMP → RVS → off.</p> 
3-2	<p>BRAKE TIME, ECHO TIME When the BRAKE or ECHO turn on, the PARAMETERS LED flashes and the BRAKE or ECHO parameter are displayed. If you use these 2 functions with default settings, there is a 4 second time out of inactivity for the BRAKE/ECHO button once selected and PARAMETERS knob if adjusted. After 4 seconds, and exits out of the BRAKE or ECHO menu.</p> <p>BRAKE TIME:</p> <p>⑥ Or when the TIME (BRAKE/ECHO) button is pressed and held in for more than 1 second while BRAKE is selected, the BRAKE time selection mode is set.</p>  <p>⑦ The BRAKE time can be selected with the PARAMETERS knob.</p> <ul style="list-style-type: none"> When the PARAMETERS knob is pressed, the time is entered and the BRAKE time selection mode is cancelled. <p>★2 The BRAKE is activated when the ► button is pushed during playback.</p> 	<p>DUMP: Reverse playback is performed for the specified time. Plays the sound backwards while continuing in a forward motion without losing "elapsed time" when you return back to normal (forward) play.</p> <p>⑭ Each pushing the ► button switches between DUMP playback and normal playback.</p> <ul style="list-style-type: none"> The reverse play turns off when the Hot Start or stutter is started.
4-3		<p>RVS (REVERSE):</p> <p>★5 Each pushing the ► button switches between reverse playback and normal playback.</p> <ul style="list-style-type: none"> The reverse play turns off when the Hot Start or stutter is started.
5		<p>PLATTER MODE MEMO The DRAG-S on/off setting and time data, the BRAKE/ECHO on/off setting and time data and the source for which the Platter effect function is to be used can be stored in the preset mode.</p> <p>• After making the desired settings, enter the preset mode and stores the settings at "PRESET (5)". Once the settings are stored, they are automatically set each time the power is turned on. (See "PRESET" on page 23.)</p>

13 MEMO (Custom Setting Memory)

CD setting information can be stored in the non-volatile memory. The stored information can be called out of the memory later, making it easy to prepare for your mixing.

1. About MEMO

- Up to 5000 memo points can be stored to internal memory for later recall.
The number of tracks on a particular CD only limits the amount of memo points available per that disc.
Example: If your CD has 22 tracks, you can only save up to 22 memos. (1 memo group per track.)

CAUTION:

5000 is the maximum possible number of tracks that can be stored to memory.

However, to simplify the MEMO operations, the memory system manages each 1250 MEMO data package as a minimum unit (the total 5000 memory capacity divided into 4 package units). When you want to clear just one MEMO data in the 1 MEMO CLEAR mode (see page 21), the unit will erase the memo information but not the internal memo allocation number. Accordingly, depending on conditions, the number of tracks that can be stored in the memory may be fewer than 5000.

Once you reached 5000 stored points, you will see a message that says "MEMO FULL!" . At this time you will need to "delete" old data to make room for new memo points. Therefore the oldest 1250 memo points will be deleted and become clear.

- Some data can be set and recalled from the memory in the Alpha-mode as well.
- The MEMO indicator on the display lights up when a track for which data is stored in the memory is selected.

2. MEMO ITEMS

The following items are max to be stored under 1 memory bank:

- ① Cue and Alpha-Cue point
- ② A1-B1 and A2-B2 points
- ③ A3-B3, A4-B4 points and A3/4 mode (not stored in the Sampler mode)
- ④ Playing pitch, pitch on/off, Key Adjust on/off setting

3. MEMO MODE SELECT

- ① Push the MEMO button in Cue mode to enter MEMO mode.
- ② Turn the PARAMETERS knob to select the various MEMO modes from as follows.

Memo Set, MemoCall, Memo Clr

Depending on conditions, some modes cannot be selected.

- ③ Push the MEMO button again to exit MEMO mode.

(1) Storing data in the memory [Memo Set]

- After make the settings to be stored in the memory, then push CUE button.
- When MEMO indicator on the display is off in Cue mode, push MEMO button to enable Memo set function.
- If MEMO indicator lights up, it is necessary to clear existing Memo before store new Memo.
- At last push PARAMETERS knob to fix. You can see "COMPLETE" message and MEMO indicator lights up.

MEMO FULL

- If the memory is full and no more data can be stored, "Memo Full!" and "Del 1250?" message appears.
- In this case, you need to clear memory of First 1250s Memo (number 1 to 1250) at a time to make space for new memos.
- To make space, push PARAMETERS knob while "Del 1250?" message is displayed.
- "Delete OK?" message appears then push PARAMETERS knob again to execute clearing.
- After the first 1250s Memo (number 1 to 1250) are cleared, number after 1251 Memo are renumbered as new 1, 2, 3...(now you have new 1250 empty space.)

(2) MEMO Call [Memo Call]

- When the CD includes tracks that DN-S5000 has Memo is inserted, MEMO indicator flashes 5 seconds.
- To call out the Memo data, select the track that you made MEMO. Then MEMO indicator lights up.
- Push the MEMO button to enable Memo call function.
- When the PARAMETERS knob is pushed in the Memo call mode, all the data stored in the memory is loaded. DN-S5000 goes to standby mode at the called Cue point.

- When the playing pitch is loaded from the Memo with PITCH LED flashes, playing Pitch is locked until Pitch Slider comes same Pitch. While playing Pitch is locked, PITCH LED keeps flashing.

Memo Call in Alpha-Mode

- In the Alpha-Mode, Memo call function can be used when Main Track is not Cue. And Memo call function can be used without changing the Main Track operations.

(3) 1 MEMO CLEAR [Memo Clr]

- To clear one Memo data, select the track that you made MEMO. Then MEMO indicator lights up.
- Push the MEMO button to enable Memo clear function.
- When the PARAMETERS knob is pushed in MEMO CLEAR mode, the Memo data is cleared and the MEMO indicator on the display turns off.

ALL MEMO CLEAR

- All memory data can be cleared.
- For instructions, see "14 PRESET (15) MEMO ALL CLEAR".

4. Copying all MEMO

- The MEMO data can be copied between DN-S5000s or DN-S5000 and DN-D9000.
- Also DN-2600F MEMO data can be copied onto the DN-S5000.
- For instructions, see "14 PRESET (16) MEMO ALL COPY".

5. X-EFFECT

- The MEMO datas of two DN-S5000 can be compared when the DN-S5000s are connected by X-EFFECT.

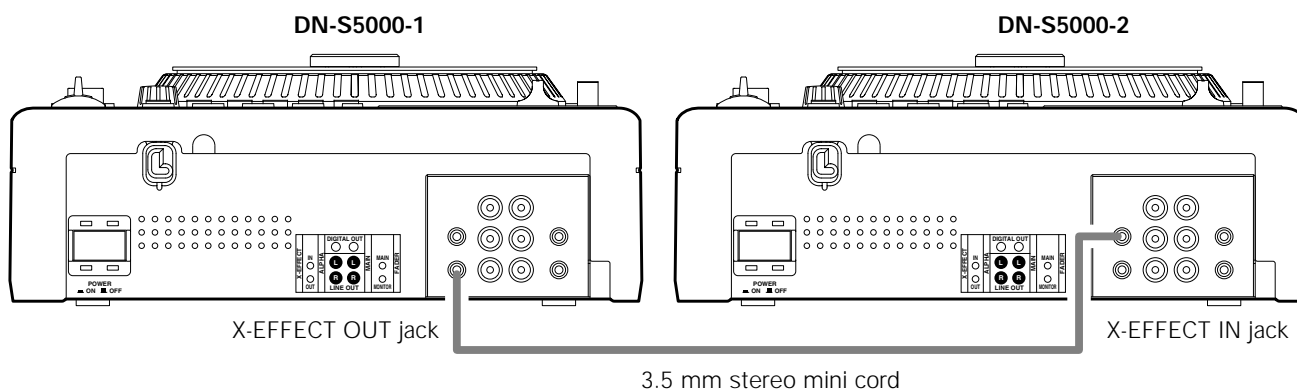

NOTE:

The MEMO data of the two DN-S5000 units is checked when the disc is loaded.

14 PRESET

1. Preset mode

- ① The preset mode is available when PRESET button is pushed for more than 1 sec while DN-S5000 is in Cue, pause or no disc mode.
- ② Turn the PARAMETERS knob to select the preset item.
- ③ After selecting an item, push the PARAMETERS knob to select the preset data.
- ④ To change other Preset items, repeat these steps.
- ⑤ Push the PRESET, CUE or PLAY/PAUSE (▶||) button to exit from the Preset mode.

2. Preset items and data

The "*" mark next to the data indicates the default value.

- (1) AUTO CUE : Auto Cue level search on/off. (ON* / OFF)
- (2) PITCH RANGE : Select the playing pitch range when the power is turned on. (± 4 / $\pm 10^*$ / ± 16 / $\pm 24\%$)
- (3) ALPHA-TRACK OUTPUT : Alpha-Track playback output destination. (Main out* / Alpha out)
- (4) PLATTER : Select whether or not the Platter is to rotate during playback. (Turn round* / Turn stop)
- (5) PLATTER MODE MEMO :
When the Platter mode (DRAG-S, BRAKE and ECHO) parameters, the source and the on/off setting are stored, the stored data is set each time the power is turned on.
 - ① To set the effect data, push the PARAMETERS knob and select "YES".
 - "Set OK?" flashes on the character display.
 - ② Push the PARAMETERS knob again and select "OK" to execute setting the data.
 - ③ Once setting is completed, "Complete!" is displayed.
- (6) AUTO LOAD : Time for automatically loading disc. (OFF / 10 / 30 / 60* seconds)
- (7) EOM : Track end message start time. (OFF / 10* / 15 / 20 / 30 / 60 / 90 seconds)
- (8) DIGITAL OUT OUTPUT LEVEL : Select the digital out output level. (Normal* / -6 dB Down)
NOTE: Use -6dB if the playback output is clipped when the Main and Alpha-Tracks are played simultaneously at the same position.
- (9) FADER START MODE: Select 2-line type (Cue and Play) or 1 line type (Play and Pause).
(Play / Cue* / Play/Pause)
- (10) POWER ON PLAY : Playback starts when the power is turned on if a disc is loaded. (On / Off*)
- (11) A3/4 MODE : Select the A3 and A4 button operating modes when the power is turned on.
(Sampler* / 4H/S / Alpha-Track H/S)
- (12) SINGLE/CONTINUOUS : Select the play mode when the power is turned on. (Single* / Continuous)
- (13) ELAPSED/REMAIN: Select the time mode when the power is turned on.
(Elapsed* / Remain)
- (14) PROGRAM ALL CLEAR : Clear all program play data in the non-volatile memory.
 - ① To clear the program, push the PARAMETERS knob and select "YES".
 - "Clear OK?" flashes on the character display.
 - ② Push the PARAMETERS knob again and select "OK" to execute clearing the program.
"Prog. Clear" is displayed on the character display while data clearing.
 - ③ Once clearing is completed, "Complete!" is displayed.
- (15) MEMO ALL CLEAR : Clear all MEMO data in the non-volatile memory.
 - ① To clear all MEMO data, push the PARAMETERS knob and select "YES".
 - "Clear OK?" flashes on the character display.
 - ② Push the PARAMETERS knob again and select "OK" to execute clearing all MEMO data.
 - "Memo Clear" is displayed on the character display while clearing.
 - ③ Once clearing is completed, "Complete!" is displayed.

(16) MEMO ALL COPY :

Copy all MEMO data from the master unit of DN-S5000 (or DN-D9000, DN-2600F) to the slave unit of DN-S5000 (or DN-D9000) when both unit are connected by the normal straight Cable. (See diagram for the cable.)

NOTE: Be sure CD player have no discs inside.

A straight cable used:

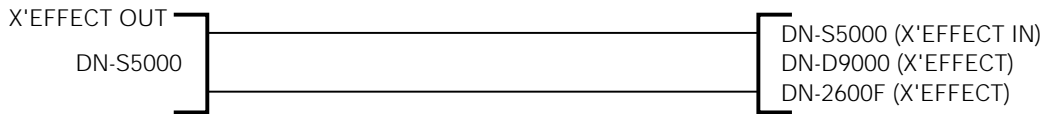

- Using the straight cable, connect the X-EFFECT terminals between two DN-S5000 units or between one DN-2600F and one DN-S5000 unit or between one DN-D9000 and one DN-S5000 unit.
- If a DN-2600F is the master unit, take the procedures below in the Preset mode of the DN-2600F beforehand. (For details, refer to the DN-2600F's operating instructions.)
 - * Set the "Copy Master" for the Preset item (14).
Then, step to the ① below on the slave unit of DN-S5000.
- Copying can be performed using the DN-S5000 and DN-D9000 in the same way as when using two units of the DN-S5000.

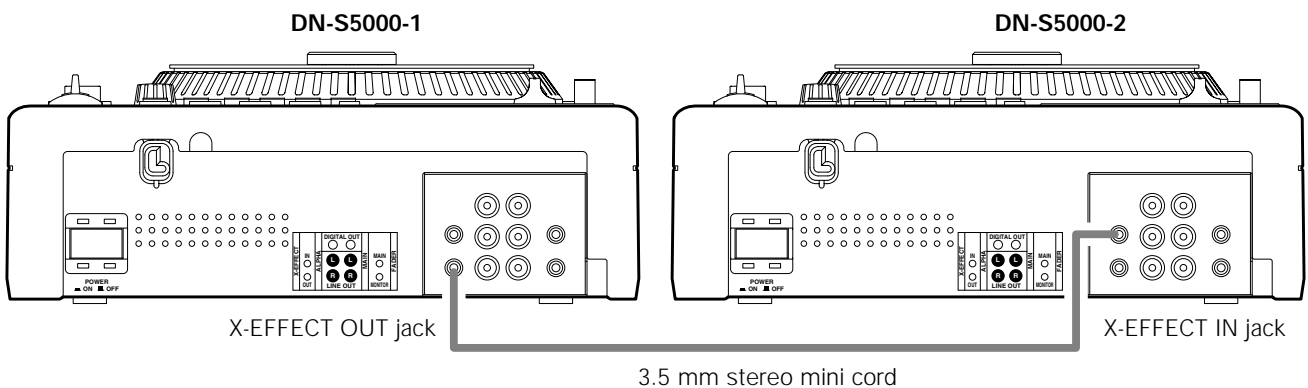

- Perform the copying operation as below on the slave unit of DN-S5000.
 - ① To start copying, push the PARAMETERS knob and select "YES". Now "Copy OK?" messages flashes on the character display.
 - ② Push the PARAMETERS knob again to confirm. Now "Start OK?" is displayed.
NOTE: If a DN-2600F is the master unit, take the procedures below in the Preset mode of the DN-2600F here.
In the Preset item (15), first start copying on the DN-2600F. Then, step to ③ below on the slave unit of DN-S5000.
 - ③ Push the PARAMETERS knob once again, and the unit starts copying when the MEMO data are received from the master unit. Now "Copying" is displayed.
 - If the master unit and the slave unit are not connected properly or the DN-2600F is not prepared to start sending data, "Not Connect" is displayed on the character display.
 - ④ When copying is completed correctly, "Complete!" is displayed.
 - "Copy Error" is displayed on the character display if copying was not completed correctly.

In this case, try the above procedure again.

- The copied MEMO data are added to the highest number area of the slave DN-S5000 unit.

(17) The DN-S5000's software version is displayed. (SYSTEM / DSP / CD DRIVE)

(18) PRESET CLEAR : Set all the preset data back to the factory defaults.

- ① To clear the PRESET data, push the PARAMETERS.
"Initial OK?" flashes on the character display.
- ② Push the PARAMETERS knob again and select "OK" to start clear the preset data.
"Preset Int" is displayed on the character display while data clearing.
- ③ Once clearing is completed, "Complete!" is displayed.

15 PROGRAM/RANDOM/RELAY PLAY/POWER ON PLAY

Program play

- Up to 25 tracks from one disc can be programmed.
- Programs for up to six discs (one program per disc) can be stored in the non-volatile memory for later recall.

NOTE: Such functions as Hot Start, Sampler, Mirror Mix, and Platter Effect do not operate during programmed playback.

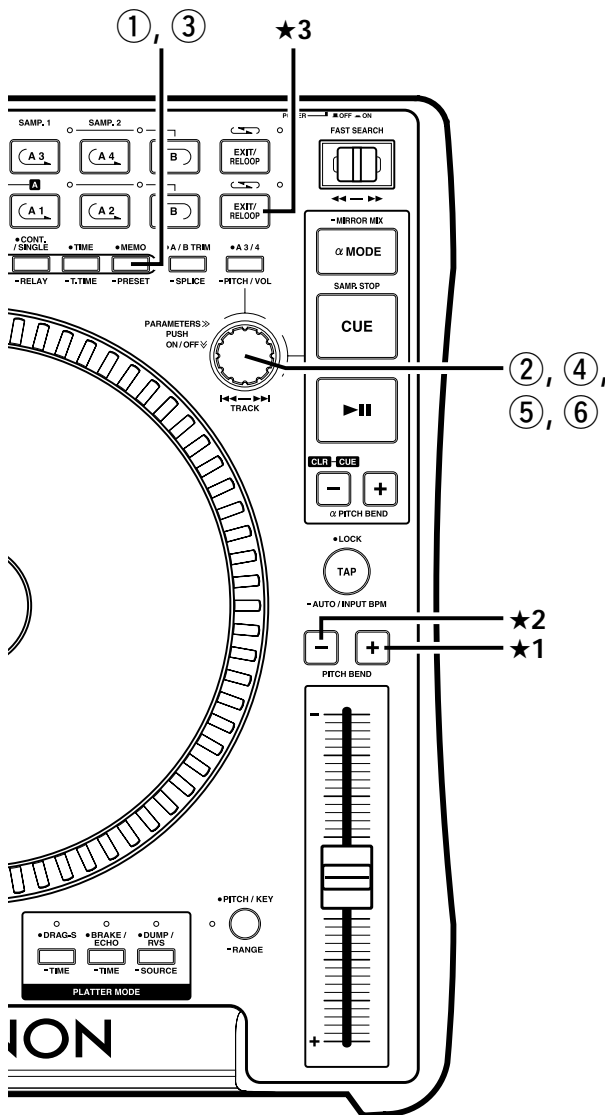

Program mode select

- ① In the Cue or pause mode, push the PRESET button for more than 1 sec to select preset mode.

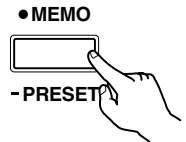

When the PRESET button is pressed at this time, the program mode is selected.

* The mode switches in the following order each time the PRESET button is pressed (short press): preset mode → program mode → random mode → off.

- ② Turn the PARAMETERS knob to select the various program setting modes as follows.

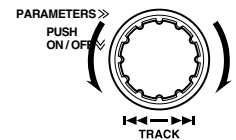

Prog.In, Prog.On, Prog.Off, MemoSet, MemoCall, MemoClr

Depending on conditions, some modes cannot be selected.

- ③ Push the PRESET button again to exit program mode.

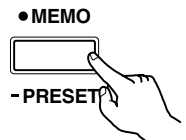

Input Program (Prog.In)

Input the program for program playback.

- ④ Turn the PARAMETERS knob to select the track.

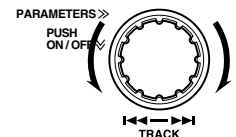

- ⑤ Push the PARAMETERS knob to input the selected track to the program.

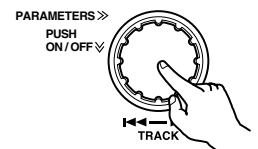

★1 Insert Tracks to Program

- You can insert tracks to the previously programmed tracks.
- One track can be inserted at a time using the PITCH BEND + button and return ④.

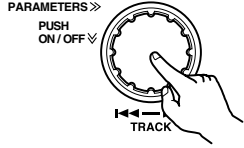
2-2	<p>★2 Clear Tracks from Program</p> <ul style="list-style-type: none"> You can clear tracks from the previously programmed tracks. One track can be cleared at a time using the PITCH BEND – button.
3	<p>⑥ Push the PARAMETERS knob again to return step 2-1 – ④.</p>  <ul style="list-style-type: none"> Repeat these steps to input whole program. Push the PRESET button to end the program input mode, then proceed to Start Program Play (Prog.On).
4	<p>Start Program Play (Prog.On)</p> <ul style="list-style-type: none"> When “Prog.On” is selected, DN-S5000 will cue up at the first track in the program. Program playback starts when the ► button is pushed. <p>★3 You can use program repeat play function with push EXIT/RELOOP button.</p>
5	<p>Cancel Program mode (Prog.Off)</p> <ul style="list-style-type: none"> When “Prog.Off” is selected, the program play mode turns off and returns to normal play mode.
6	<p>Store Program (MemoSet)</p> <ul style="list-style-type: none"> When “Memo Set” is selected, the program that has been set is stored in the non-volatile memory.
7	<p>Call Program (MemoCall)</p> <ul style="list-style-type: none"> When “MemoCall” is selected, the program stored in the non-volatile memory is loaded and the program play mode is set.
8	<p>Clear Program (Memo Clr)</p> <ul style="list-style-type: none"> When “Memo Clr” is selected, the program for the loaded disc is cleared. To clear all Program Memo use Preset function.

Random playback

- With the random play function, tracks are selected at random and played from the disc.

NOTE: Such functions as Hot Start, Sampler, Mirror Mix and Platter Effect do not operate during random playback.

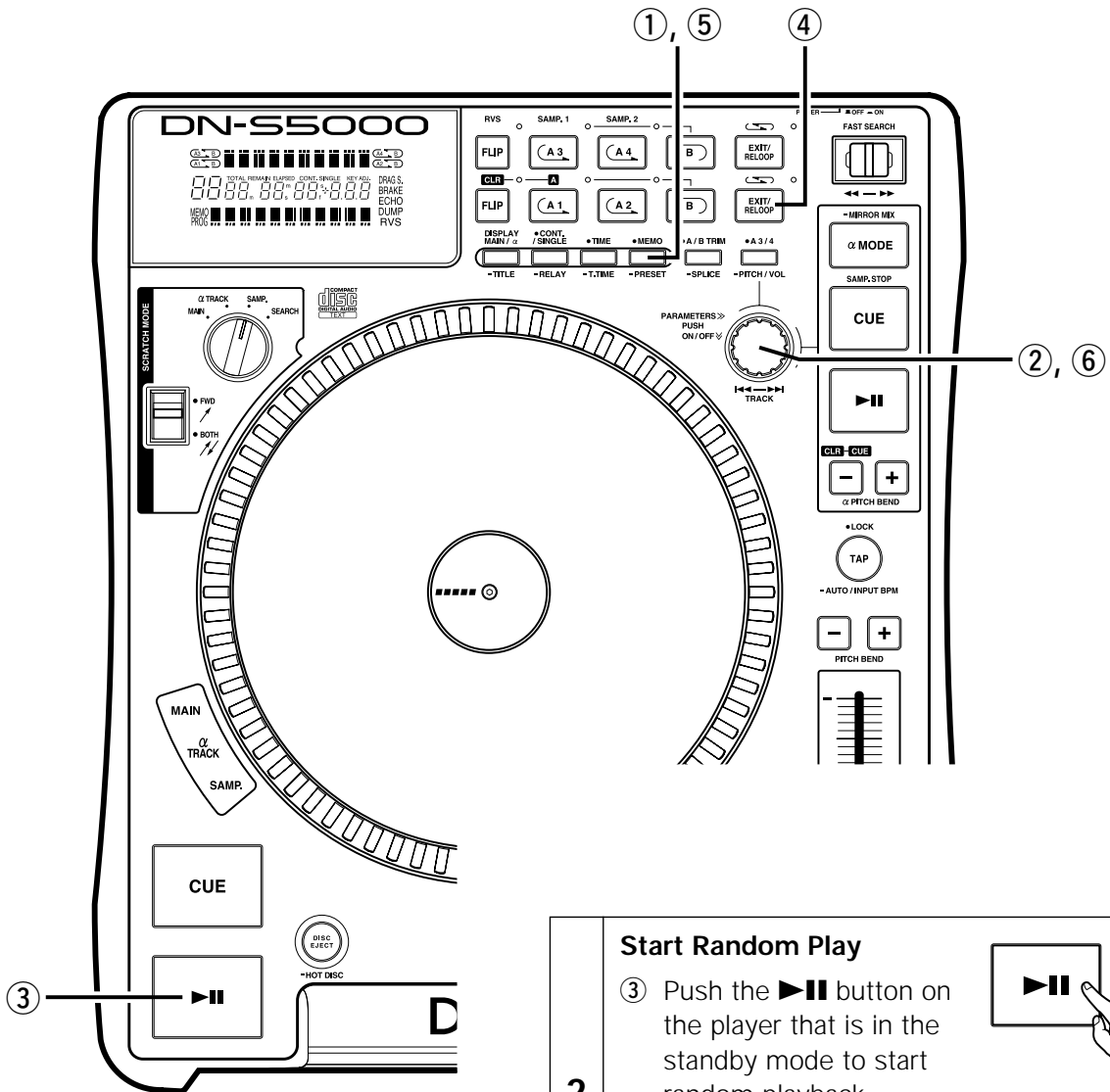

1 Random Play mode (Random On)

① In the Cue or pause mode, push the PRESET button for more than 1 sec to select preset mode. "Random On?" is selected when the PRESET button is pressed twice at this time.

② Push PARAMETERS knob to set the random play mode. The unit will standby at a track selected at random.

2 Start Random Play

③ Push the ►|| button on the player that is in the standby mode to start random playback.

④ You can use random repeat play function by pushing the EXIT/RELOOP button.

3 Cancel Random Play (RandomOff)

⑤ "Random Off" can be selected when the PRESET button is pushed during random playback.

⑥ Push PARAMETERS knob to cancel Random play. The unit will return to the normal play mode.

Relay playback

- Relay Play function is a playback mode to continue play tracks of CDs in two DN-S5000s.
- Connect the X-EFFECT IN/OUT terminals between two DN-S5000s.

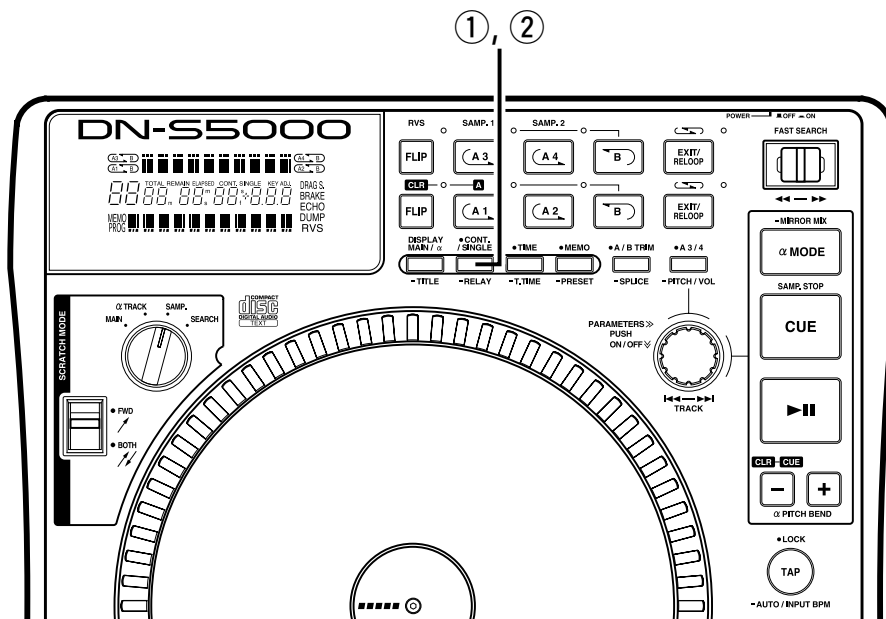

Start Relay Play

- 1 Push the RELAY button for more than 1 sec to enable Relay play mode. You can set Relay mode as below.

- In the single play mode, when the one player's playback reaches end of track, another DN-S5000 starts playing.
- In the continuous play mode, when the whole tracks on one side are finished, another DN-S5000 starts.
- The discs in two DN-S5000s can be played alternately by setting both DN-S5000 to the relay play mode.
- Relay play can be set in the program and random play modes.

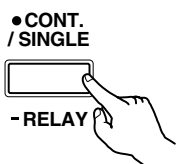

Stop Relay Play

- 2 When the RELAY button is pushed for more than 1 sec while in the relay play mode, the relay play mode is turned off.

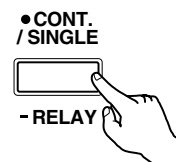

Power on play

- When "POWER ON PLAY" is set to "ON" at "14 PRESET (10)", playback starts from the first track on the disc when the power is turned on.

16 SPECIFICATIONS

GENERAL

Type:	Compact disc player
Disc type:	Standard compact discs (12 cm discs), CD-TEXT CD-R, CD-RW discs NOTE: Finalized CD-R or CD-RW discs can be played back in this unit. However, according to recording quality, some CD-R/RW discs cannot be played.
Dimensions:	Player unit: 285 (W) x 111.5 (H) x 327 (D) mm (without feet) 11-7/32" (W) x 4-25/64" (H) x 12-7/8" (D)
Installation:	Table top type
Mass:	Player unit: 5.7 kg (12 lbs 9 oz)
Power supply:	U.S.A., Canada and Taiwan R.O.C. models: 120 V AC $\pm 10\%$, 60 Hz European models: 230 V AC $\pm 10\%$, 50 Hz
Power consumption:	18 W
Environmental conditions:	Operational temperature: 5 to 35°C (41 to 95°F) Operational humidity: 25 to 85% (no condensation) Storage temperature: -20 to 60°C (4 to 140°F)

AUDIO SECTION

Main out, Monitor out

Quantization:	24-bit linear per channel
Sampling frequency:	44.1 kHz at normal pitch
Oversampling rate:	8 times
Total harmonic distortion:	0.01% or less
Signal to noise ratio:	90 dB or more
Channel separation:	85 dB or more
Frequency response:	20 to 20,000 Hz

Analog output

Output level:	2.0 V r.m.s.
Load impedance:	10 k Ω /kohms or more

Digital output

Signal format:	SPDIF
Output level:	0.5 Vp-p 75 Ω /ohms

FUNCTIONS

Instant start:	Within 20 msec.
Variable pitch:	$\pm 4\%$ (0.05% pitch), $\pm 10\%$ (0.1% pitch), $\pm 16\%$ (0.1% pitch) $\pm 24\%$ (0.1% pitch), $\pm 100\%$ (1.0% pitch)
Pitch bend:	Pitch range $\pm 32\%$ Pitch range $\pm 100\%$: $\pm 99\%$
Sampler	
Sampling:	44.1 kHz
Length:	15 sec.
Output level:	2.0 V r.m.s. (Variable / -14 ~ +6 dB)
Variable pitch:	$\pm 24\%$ (0.1% pitch)
Search precision:	1/75 sec. (1 subcode frame)
Max. scan speed:	Over 20 times normal speed
Max. MEMO memory steps:	5000 steps

* Specifications and design are subject to change without notice for purpose of improvement.

17 REPLACING THE BELT

- On the DN-S5000, the platter is driven by a belt.
- In the unlikely case of trouble, use the procedure described below to replace the belt.

1. Remove a screw **(A)** (Hexagon socket head) and pull out Scratch Disc and Slip Mat.

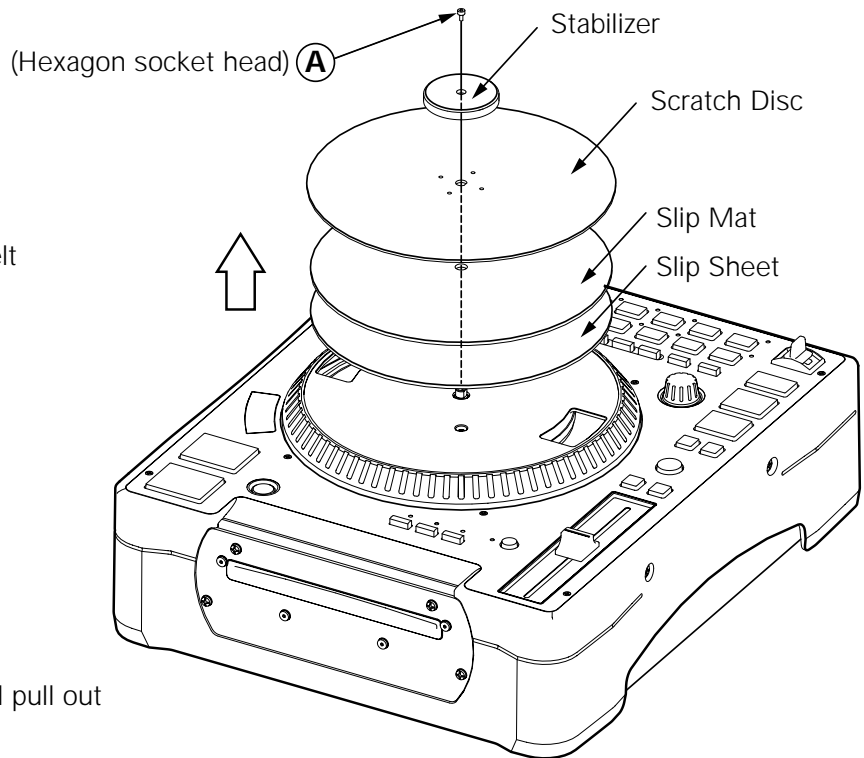

2. Remove Belt from Motor Pully.

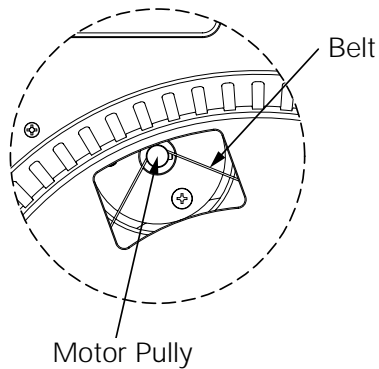

3. Remove 3 screws **(B)** (\oplus head) and pull out Platter.

4. Remove Belt from Platter.

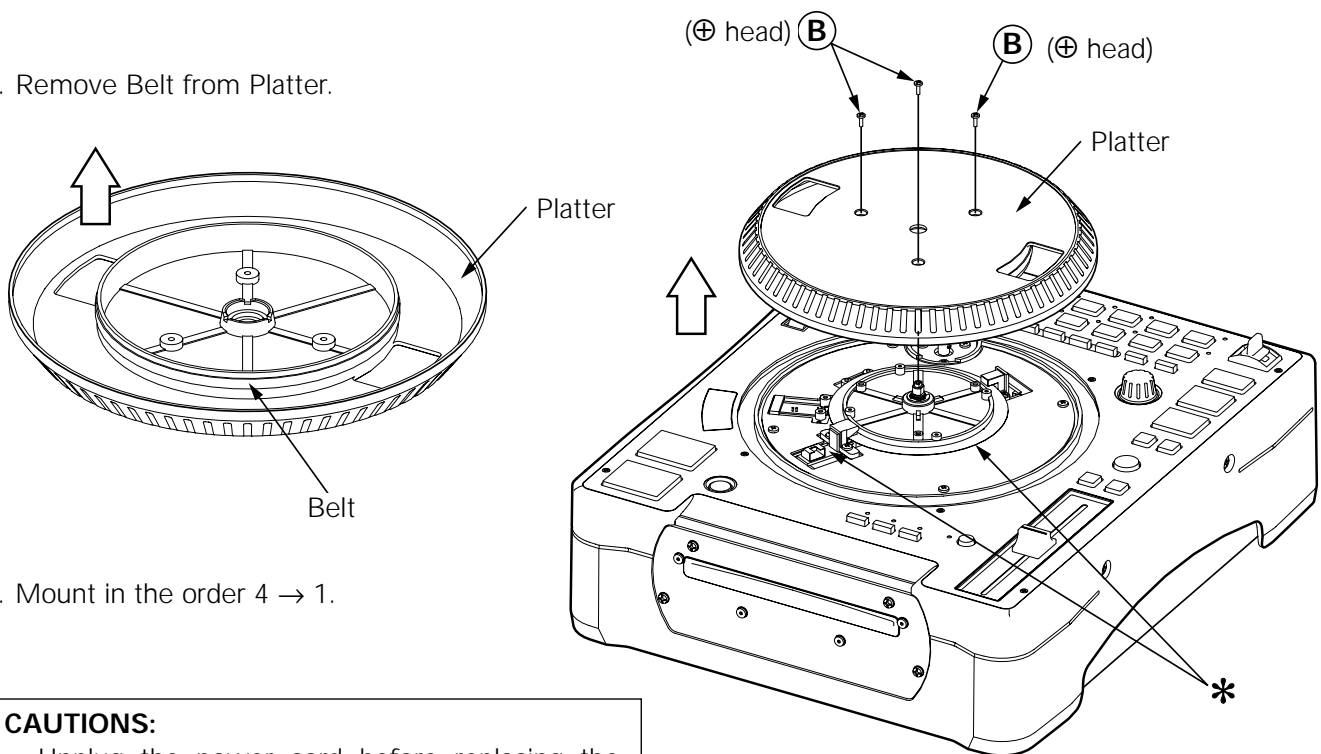

5. Mount in the order 4 \rightarrow 1.

CAUTIONS:

- Unplug the power cord before replacing the belt.
- Do not touch the sensor or scale(*) when removing the Platter.
- Do not apply oil or grease to the belt when replacing it.

D&M Holdings Inc.
PROFESSIONAL BUSINESS COMPANY

7-35-1 Sagamiono, Sagamihara-shi, Kanagawa 228-8505, JAPAN