



Sub1 & Sub2

Powered Bass Modules

Owner's Guide







Please read and keep all safety and use instructions.

Important Safety Instructions

 Bose Corporation hereby declares that this product is in compliance with the essential requirements and other relevant provisions of Directive 2014/53/EU and all other applicable EU directive requirements. The complete declaration of conformity can be found at: www.bose.com/compliance.

1. Read these instructions.
2. Keep these instructions.
3. Heed all warnings.
4. Follow all instructions.
5. Do not use this apparatus near water.
6. Clean only with a dry cloth.
7. Do not block any ventilation openings. Install in accordance with the manufacturer's instructions.
8. Do not install near any heat sources such as radiators, heat registers, stoves, or other apparatus (including amplifiers) that produce heat.
9. Do not defeat the safety purpose of the polarized or grounding-type plug. A polarized plug has two blades with one wider than the other. A grounding type plug has two blades and a third grounding prong. The wide blade or the third prong are provided for your safety. If the provided plug does not fit into your outlet, consult an electrician for replacement of the obsolete outlet.
10. Protect the power cord from being walked on or pinched, particularly at plugs, convenience receptacles, and the point where it exits from the apparatus.
11. Only use attachments/accessories specified by the manufacturer.
12.  Use only with the cart, stand, tripod, bracket, or table specified by the manufacturer or sold with the apparatus. When a cart is used, use caution when moving the cart/apparatus combination to avoid injury from tip-over.
13. Unplug this apparatus during lightning storms or when unused for long periods of time.
14. Refer all servicing to qualified personnel. Servicing is required when the apparatus has been damaged in any way such as power-supply cord or plug is damaged, liquid has been spilled or objects have fallen into the apparatus, the apparatus has been exposed to rain or moisture, does not operate normally, or has been dropped.

WARNINGS/CAUTIONS

-  This symbol on the product means there is uninsulated, dangerous voltage within the product enclosure that may present a risk of electrical shock.
-  This symbol on the product means there are important operating and maintenance instructions in this guide.
-  Contains small parts which may be a choking hazard. Not suitable for children under age 3.
-  This product contains magnetic material. Consult your physician on whether this might affect your implantable medical device.
-  Use at altitude less than 2000 meters only.
-  This symbol on the product means there is a tip-over hazard when using a pole mount.
-  Do not alter, modify, or remove the sliding cover over the power input of the Sub1/Sub2. There is uninsulated, dangerous voltage within the product enclosure that may present a risk of electrical shock.

- The pole-mount M20 threaded insert on the Sub1 and Sub2 is designed to support a pole of up to 1.3 meters (51 inches) with a Bose S1 Pro mounted on the pole. Do not use the Sub1 or Sub2 with a pole exceeding 1.3 meters (51 inches) in height or a loudspeaker weight that exceeds 71 kilograms (15.7 pounds). Using a pole/loudspeaker combination that exceeds either of these limits or creates an unstable mounting scenario may lead to a hazardous condition that could result in injury.
- Do NOT make unauthorized alterations to this product.
- Do NOT use in vehicles or boats.
- Do NOT place the product in a confined space such as in a wall cavity or in an enclosed cabinet while in use.
- Keep the product away from fire and heat sources. Do NOT place naked flame sources,

such as lighted candles, on or near the product.

- To reduce the risk of fire or electrical shock, do NOT expose the product to rain, liquids, or moisture.
- Do NOT expose this product to dripping or splashing and do not place objects filled with liquids, such as vases, on or near the product.
- Do NOT use a power inverter with this product.
- Provide an earth connection or ensure the socket outlet incorporates a protective earthing connection before connecting the plug to the mains socket outlet.
- Where the mains plug or an appliance coupler is used as the disconnect device, the disconnect device shall remain readily operable.

Regulatory Information

The product, in accordance with the Ecodesign Requirements for Energy Related Products Directive 2009/125/EC, is in compliance with the following norm(s) or document(s): Regulation (EC) No. 1275/2008, as amended by Regulation (EU) No. 801/2013.

Required Power State Information	Power Modes	
	Standby	Networked Standby
Power consumption in specified power mode, at 230V/50Hz input	≤ 0.5 W	N/A*
Time after which equipment is automatically switched into mode	4 hours	N/A*
Power consumption in networked standby if all wired network ports are connected and all wireless network ports are activated, at 230V/50Hz input	N/A*	
Network port deactivation/activation procedures. Deactivating all networks will enable standby mode.	*Product does not utilize a networked standby mode for a Bluetooth® connection and does not have the ability to be configured to a network via Wi-Fi® or Ethernet	

	Sub1	Sub2
Dimensions (H × W × D)	53.0 × 25.0 × 53.0 cm (20.9 × 9.8 × 20.9 in)	69.0 × 30.5 × 55.0 cm (27.2 × 12.0 × 21.7 in)
Net Weight	16.1 kg (35.5 lb)	23.4 kg (51.7 lb)
Input Rating	100–240 VAC, 3 A, 50/60 Hz	100–240 VAC, 4 A, 50/60 Hz
Initial turn on inrush current	14.9 A at 120 V; 29.3 A at 230 V	15.2 A at 120 V; 28.6 A at 230 V
Inrush current after AC mains interruption of 5 s	5.8 A at 120 V; 32.0 A at 230 V	2.6 A at 120 V; 6.1 A at 230 V

Shielded cables are required to maintain regulatory compliance.

The product label is located on the bottom of the product.

Model: 431389G1 / 431389G2. The CMIIT ID is located on the bottom of the product.

CAN ICES-3 (B)/NMB-3(B)

Information About Products That Generate Electrical Noise (FCC Compliance Notice for US)

NOTE: This equipment has been tested and found to comply with the limits for a Class B digital device, pursuant to Part 15 of the FCC Rules. These limits are designed to provide reasonable protection against harmful interference in a residential installation. This equipment generates, uses, and can radiate radio frequency energy and, if not installed and used in accordance with the instructions, may cause harmful interference to radio communications. However, there is no guarantee that interference will not occur in a particular installation. If this equipment does cause harmful interference to radio or television reception, which can be determined by turning the equipment off and on, the user is encouraged to try to correct the interference by one or more of the following measures:

- Reorient or relocate the receiving antenna.
- Increase the separation between the equipment and receiver.
- Connect the equipment into an outlet on a circuit different from that to which the receiver is connected.
- Consult the dealer or an experienced radio/TV technician for help.

Changes or modifications not expressly approved by Bose Corporation could void the user's authority to operate this equipment.

This device complies with part 15 of the FCC Rules and with ISED Canada's license-exempt RSS standard(s). Operation is subject to the following two conditions: (1) This device may not cause harmful interference, and (2) this device must accept any interference received, including interference that may cause undesired operation.



This symbol means the product must not be discarded as household waste, and should be delivered to an appropriate collection facility for recycling. Proper disposal and recycling helps protect natural resources, human health, and the environment. For more information on disposal and recycling of this product, contact your local municipality, disposal service, or the shop where you bought this product.

China Restriction of Hazardous Substances Table

Names and Contents of Toxic or Hazardous Substances or Elements						
Toxic or Hazardous Substances and Elements						
Part Name	Lead (Pb)	Mercury (Hg)	Cadmium (Cd)	Hexavalent (CR(VI))	Polybrominated Biphenyl (PBB)	Polybrominated diphenylether (PBDE)
PCBs	X	0	0	0	0	0
Metal Parts	X	0	0	0	0	0
Plastic Parts	0	0	0	0	0	0
Speakers	X	0	0	0	0	0
Cables	X	0	0	0	0	0

This table is prepared in accordance with the provisions of SJ/T 11364.
 O: Indicates that this toxic or hazardous substance contained in all of the homogeneous materials for this part is below the limit requirement of GB/T 26572.
 X: Indicates that this toxic or hazardous substance contained in at least one of the homogeneous materials used for this part is above the limit requirement of GB/T 26572.

Taiwan Restriction of Hazardous Substances Table

Equipment name: Sub1/Sub2 Type designation: 431389G1 / 431389G2						
Restricted substances and its chemical symbols						
Unit	Lead (Pb)	Mercury (Hg)	Cadmium (Cd)	Hexavalent chromium (Cr+6)	Polybrominated biphenyls (PBB)	Polybrominated diphenyl ethers (PBDE)
PCBs	-	o	o	o	o	o
Metal Parts	-	o	o	o	o	o
Plastic Parts	o	o	o	o	o	o
Speakers	-	o	o	o	o	o
Cables	-	o	o	o	o	o

Note 1: "o" indicates that the percentage content of the restricted substance does not exceed the percentage of reference value of presence.
Note 2: The "-" indicates that the restricted substance corresponds to the exemption.



Date of Manufacture: The eighth digit in the serial number indicates the year of manufacture; "0" is 2010 or 2020.

China Importer: Bose Electronics (Shanghai) Company Limited, Part C, Plant 9, No. 353 North Ruying Road, China (Shanghai) Pilot Free Trade Zone

EU Importer: Bose Products B.V., Gorslaan 60, 1441 RG Purmerend, The Netherlands

Mexico Importer: Bose de México, S. de R.L. de C.V. , Paseo de las Palmas 405-204, Lomas de Chapultepec, 11000 México, D.F. For service or importer information, call +5255 (5202) 3545

Taiwan Importer: Bose Taiwan Branch, 9F-A1, No. 10, Section 3, Minsheng East Road, Taipei City 104, Taiwan. Phone Number: +886-2-2514 7676

Bose Corporation Headquarters: 1-877-230-5639

Wi-Fi is a registered trademark of Wi-Fi Alliance®

Bose, LI, and SubMatch are trademarks of Bose Corporation.

All other trademarks are the property of their respective owners.

The Bose Privacy Policy is available on the Bose website.

©2020 Bose Corporation. No part of this work may be reproduced, modified, distributed or otherwise used without prior written permission.

Please complete and retain for your records.

The serial and model numbers are located on the product label on the bottom of the product.

Serial number: _____

Model number: _____

Warranty Information

This product is covered by a limited warranty.
 For warranty details, visit global.bose.com/warranty.

Overview	5
Package Contents	5
Optional Accessories	5
Setup	6
Connections and Controls	6
Connecting Power.....	7
Connecting Directly to a Power Outlet.....	7
Connecting to an L1 Pro32 with a SubMatch Cable.....	8
AutoOff/Low-power Standby.....	8
Inputs and Outputs.....	9
Line Input	9
Line Output	9
Settings.....	9
Phase/Pattern.....	9
Level	10
Line Input EQ.....	10
Line Output EQ.....	10
Sub1/Sub2 Orientation	10
Using the Pole-mount Insert with an S1 Pro	11
Care & Maintenance	12
Cleaning Your Sub.....	12
Troubleshooting	12

Overview

Package Contents

Sub1

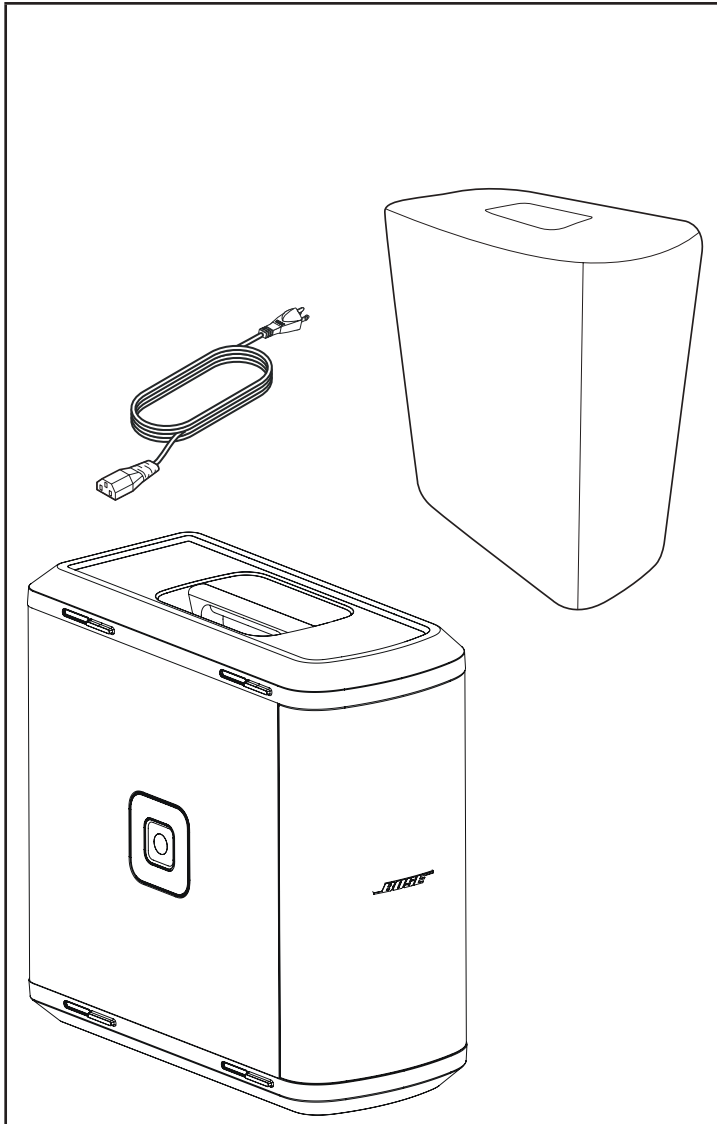

Sub2

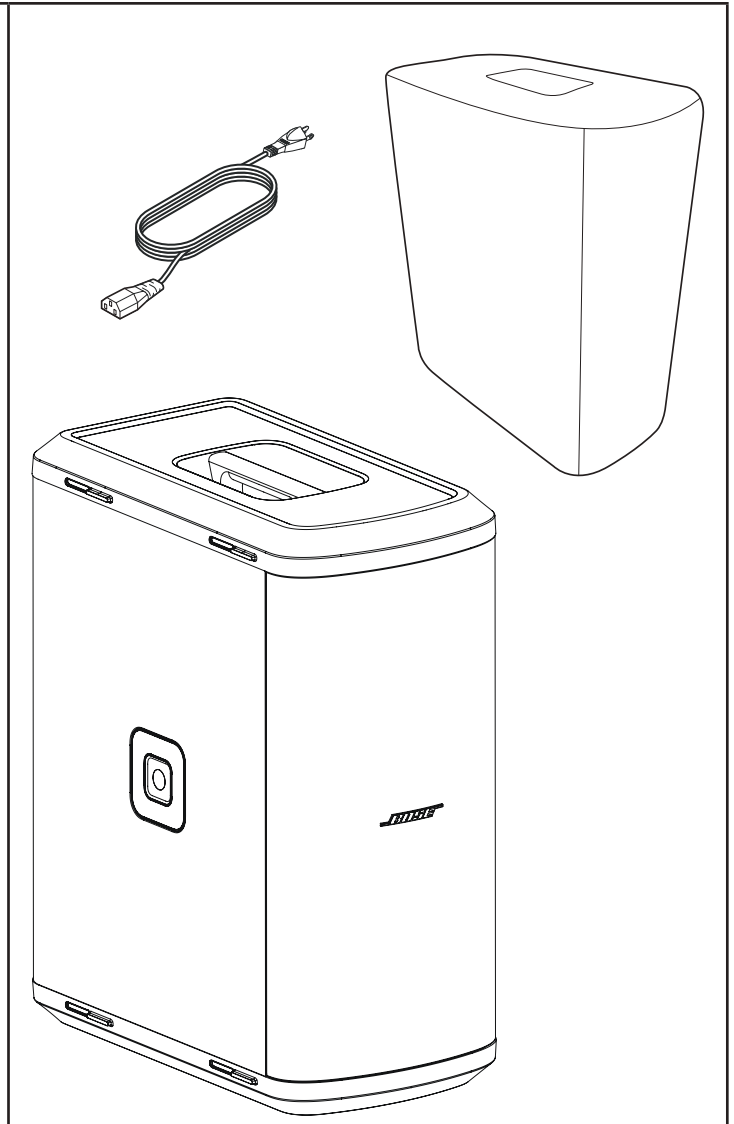

Optional Accessories

- Sub1/Sub2 Roller Bag
- Sub1/Sub2 Adjustable Speaker Pole
- SubMatch Cable

For additional information on Sub1/Sub2 accessories, visit PRO.BOSE.COM.

Setup

Connections and Controls

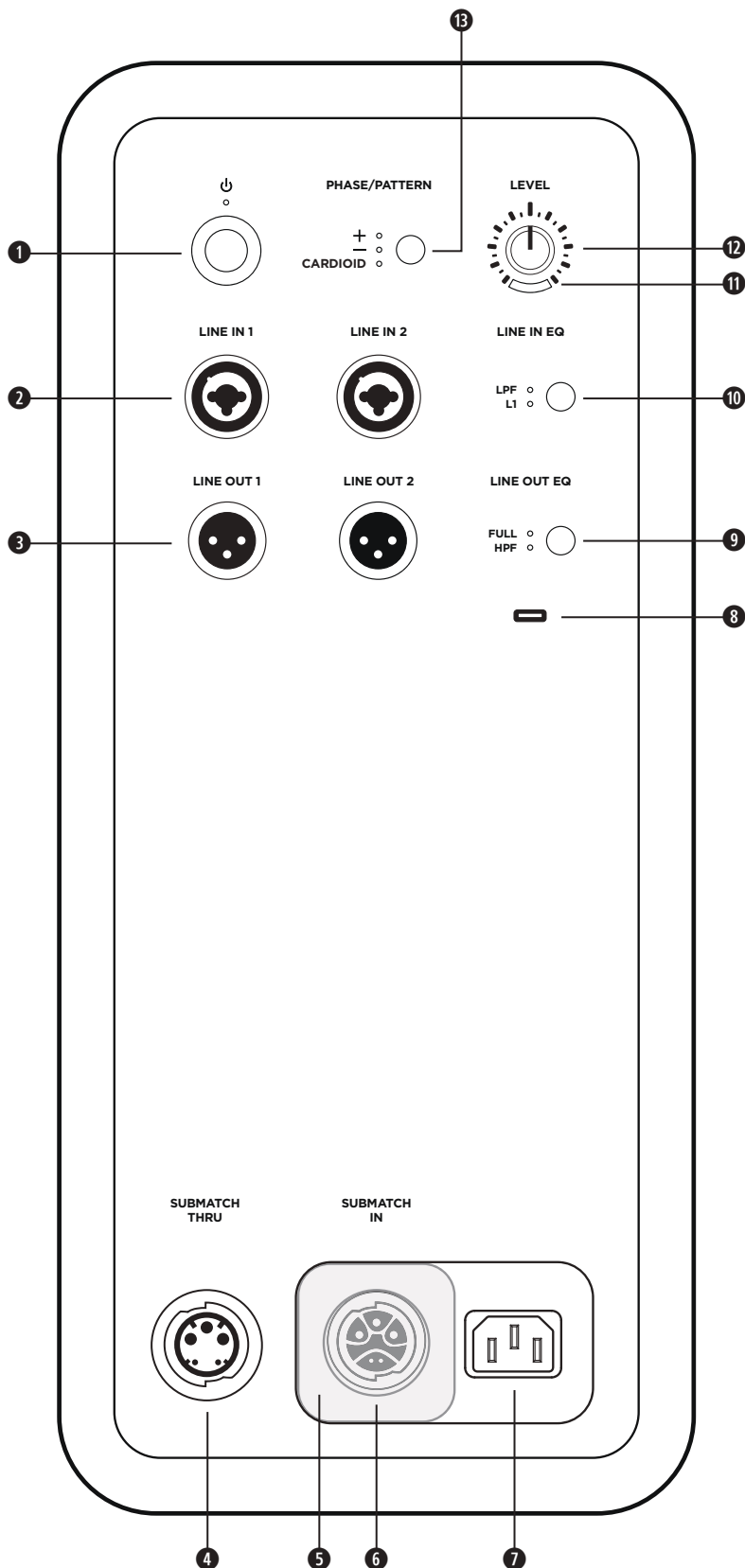

- 1 **Standby Button:** Press the button to power on the Sub. The LED will illuminate white while the Sub is on.
- 2 **Line Inputs:** Analog input for connecting an L1 Pro or other line-level audio source. Compatible with XLR, TRS balanced, and TS unbalanced cables.
- 3 **Line Outputs:** Use an XLR cable to connect the line-level output to a loudspeaker.
- 4 **SubMatch ThruPut:** Connect an additional Sub bass module with a SubMatch cable. Up to two Sub1 or Sub2 powered bass modules can be powered by a single L1 Pro32 via SubMatch connection.
- 5 **Power Input Cover:** Prevents simultaneous use of the **SubMatch Input** and **Power Input**. Slide the cover to reveal the power input that is needed for setup.
- 6 **SubMatch Input:** Connect the Sub to an L1 Pro32 with a SubMatch cable.
- 7 **Power Input:** IEC power cord connection.
- 8 **USB Port:** USB-C connector for Bose service use and firmware updates.
Note: This port is not compatible with Thunderbolt 3 cables.
- 9 **Line Output EQ:** Select between **FULL** bandwidth or a multi-purpose HPF when using **Line Outputs**. Press the button to switch EQ settings. The corresponding LED will illuminate white while selected.
- 10 **Line Input EQ:** Select between an optimized EQ for an L1 Pro or a multi-purpose LPF when using **Line Inputs**. Press the button to switch EQ settings. The corresponding LED will illuminate white while selected.
- 11 **Signal/Clip Indicator:** The LED will illuminate green when a signal is present and will illuminate red when the signal is clipping or the Sub is entering limiting. Reduce the level or signal volume to prevent signal clipping or limiting.
- 12 **Level Control:** Adjust the level of audio output. The **Level Control** does not affect the **Line Outputs**. The 12 o'clock position is recommended when in use with an L1 Pro32.
- 13 **Phase/Pattern Button:** Adjust the polarity of the Sub. Press the button to switch polarity. The corresponding LED will illuminate white while selected. Also allows access to Cardioid mode when using two identical Sub modules.

Connecting Power

There are two ways to connect a Sub to power: connecting to a power outlet or connecting to an L1 Pro32 with a SubMatch cable. The **Power Input Cover** prevents simultaneous connection of both power inputs. Only one of the two power connections should be used at a time.

If connecting directly to a power outlet, slide the **Power Input Cover** to the left, concealing the SubMatch Input. If connecting to an L1 Pro32 with a SubMatch cable, slide the **Power Input Cover** to the right, concealing the **Power Input**.

 **WARNING:** Do not alter, modify, or remove the sliding cover over the power input of the Sub1/Sub2. There is uninsulated, dangerous voltage within the product enclosure that may present a risk of electrical shock.

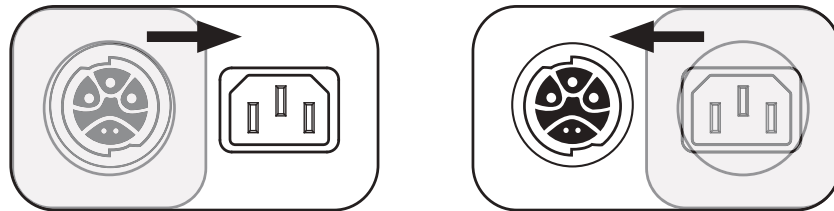

Connecting Directly to a Power Outlet

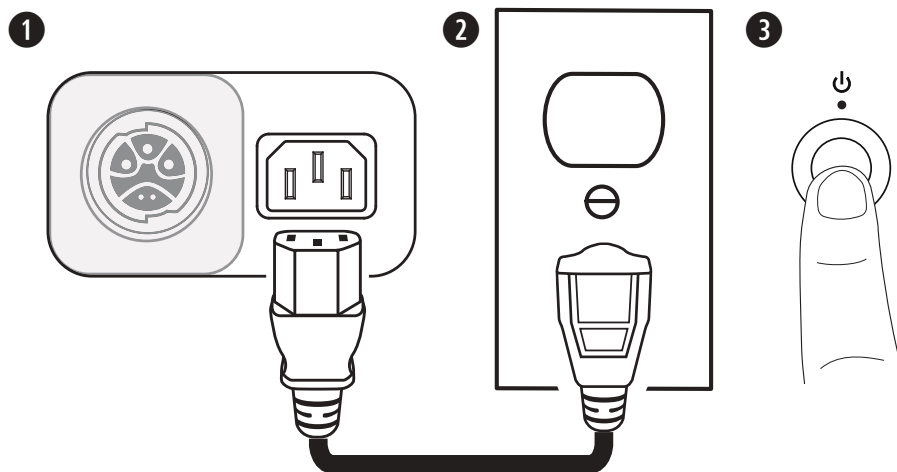

1. Plug the power cord into the **Power Input**.
2. Plug the other end of the power cord into a live electrical outlet.

Note: Do not power on the Sub until after you've connected your sources.

3. Press the **Standby Button**. The LED will illuminate white while the Sub is on.

Connecting to an L1 Pro32 with a SubMatch Cable

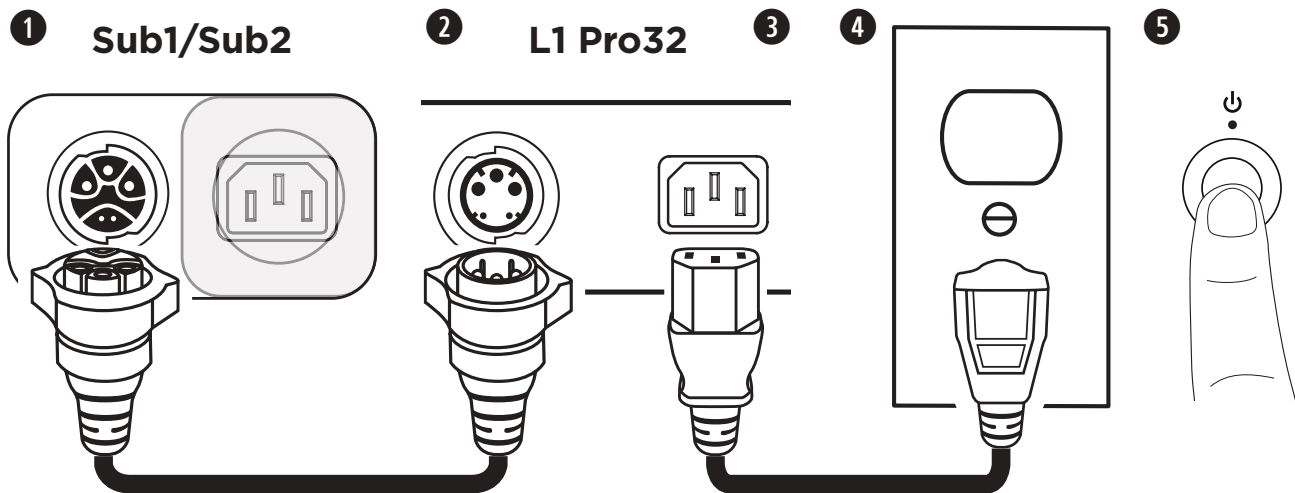

1. Plug the SubMatch cable into the **SubMatch Input** on a Sub1/Sub2.
2. Plug the other end of the SubMatch cable into the **SubMatch Output** of the L1 Pro32.
3. Plug the power cord into the **Power Input** on the L1 Pro32.
4. Plug the other end of the power cord into a live electrical outlet.

Note: Do not power on the L1 Pro or the Sub until after you've connected your sources. See the L1 Pro32 owner's guide at PRO.BOSE.COM for more information about connecting sources to an L1 Pro32.

5. Press the **Standby Button** on the L1 Pro32 then press the **Standby Button** on the Sub. The LEDs will illuminate white while the L1 Pro and Sub are on.

Note: Press and hold the **Standby Button** for 10 seconds to reset the Sub to factory settings.

When using two Subs via SubMatch cable connection, first turn on the Sub connected directly to the L1 Pro32, then turn on the second Sub.

AutoOff/Low-power Standby

After four hours of no use, the Sub will enter AutoOff/Low-power Standby mode to save power. To wake the Sub from AutoOff/Low-power Standby mode, press the **Standby Button**.

Note: Disable AutoOff/Low-power Standby mode by pressing and holding the **Phase/Pattern Button** and **Line Output EQ** button simultaneously for 10 seconds. Enable AutoOff/Low-power Standby mode by repeating this step. Disabling AutoOff/Low-power Standby mode will result in higher energy usage when the Sub is not in use.

Inputs and Outputs

Line Input

Analog input for connecting an L1 Pro or other line-level audio source. Compatible with XLR, TRS balanced, and TS unbalanced cables. Use **Line Input 1** (Left) and **Line Input 2** (Right) together for stereo applications.

Line Output

Use an XLR cable to connect the line-level output to a loudspeaker. Use **Line Output 1** (Left) and **Line Output 2** (Right) together for stereo applications.

Settings

Phase/Pattern

Adjust the polarity of the Sub. Press the button to switch between positive polarity (+) and inverted polarity (-). The corresponding LED will illuminate white while selected. Choose the polarity that sounds best for your application.

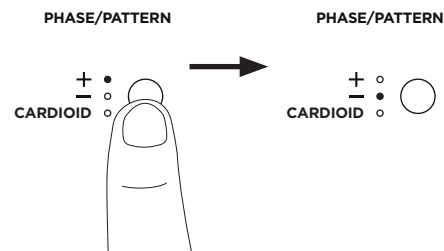

Cardioid Mode

Cardioid mode is for use with a stack of two identical Sub modules, which allows for most of the sound energy to be focused in front of the Sub stack while reducing the sound energy that is generated behind the Sub stack. Press and hold the button for four seconds to select **CARDIOID**. The LED will illuminate white while selected. Press and hold again to switch back to +. Cardioid mode should only be used in a stacked configuration of two identical Sub modules, with the top Sub facing the coverage area and the bottom Sub facing the non-coverage area. Set the **Phase/Pattern** of the top Sub to + and the **Phase/Pattern** of the bottom Sub to **CARDIOID**. When adjusting the level of the stacked subs in Cardioid mode, be sure that the **Level Control** is set to the same position on both Subs. See the below diagrams for Sub stack orientation and coverage patterns.

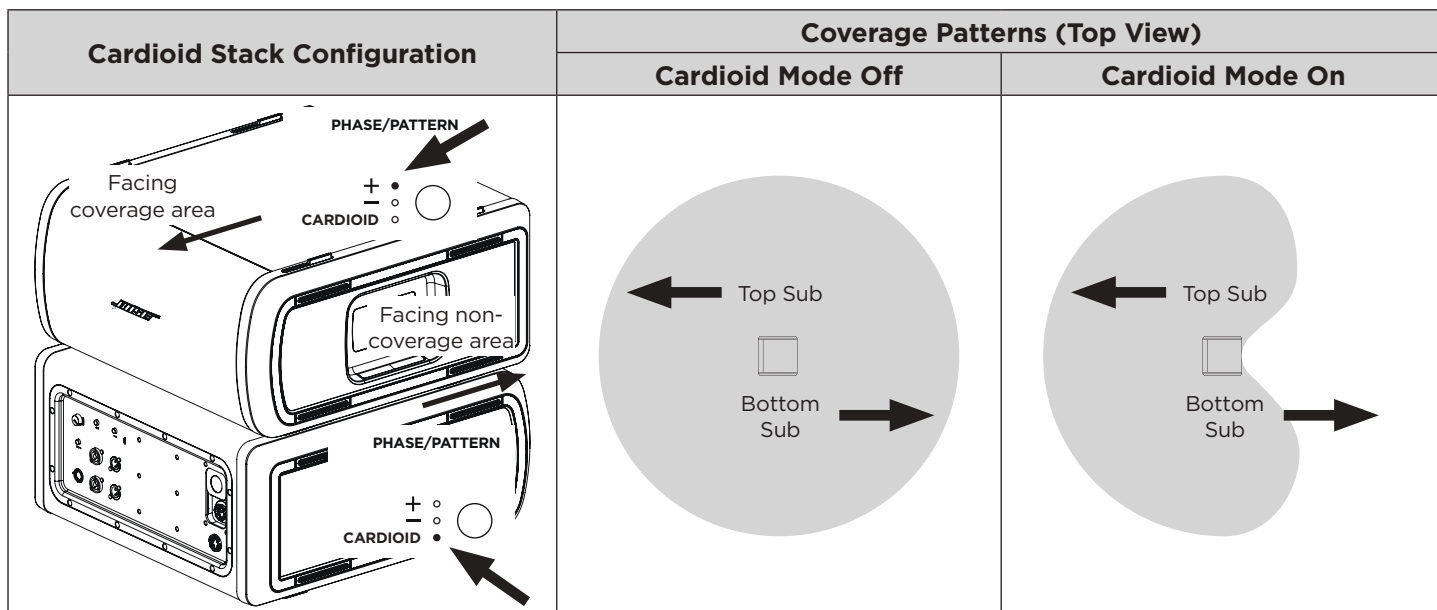

Level

Adjust the level of audio output from the Sub. Begin with the **Level Control** set to a low setting and increase the level until the **Signal/Clip Indicator** illuminates green. The **Level Control** does not affect the **Line Outputs**. The 12 o'clock position is recommended when in use with an L1 Pro32. If using two Subs with a single L1 Pro, it is recommended that the **Level Control** is set to the same position on both Subs.

Line Input EQ

Change the EQ of both **Line Inputs** by pressing the **Line Input EQ** button until the corresponding LED for your desired EQ illuminates white. Use **L1** to apply an input EQ optimized for L1 Pro products; use **LPF** to apply a low-pass filter to the inputs. When a Sub is connected to an L1 Pro32 with a SubMatch cable, the **Line Input EQ** will be fixed to **L1**.

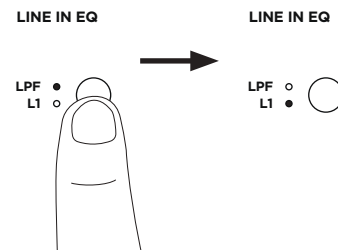

Line Output EQ

Change the EQ of both **Line Outputs** by pressing the **Line Output EQ** button until the corresponding LED for your desired EQ illuminates white. Use **FULL** for full frequency or **HPF** to apply a high-pass filter to the outputs.

Note: If using the Sub with an S1 Pro, press and hold the **Line Output EQ** button for four seconds to enable an EQ specifically optimized for use with an S1 Pro. The **HPF** LED will illuminate green. To deactivate the S1 Pro EQ, press and hold for four seconds.

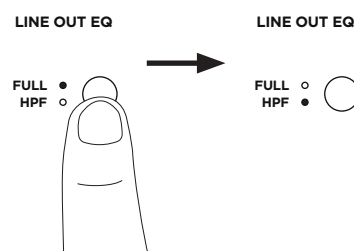

Sub1/Sub2 Orientation

WARNING: Do not place the equipment in an unstable location. The equipment could become unstable leading to a hazardous condition, which could result in injury.

CAUTION: Do not stack more than two Subs together. Only stack two Subs of the same model.

For horizontal configurations, adjust the logo by rotating it.

For stacked configurations, the Sub includes four interlocking feet that will attach to another Sub of the same model. When stacking Subs horizontally, always make sure the feet lock together before connecting power and sources.

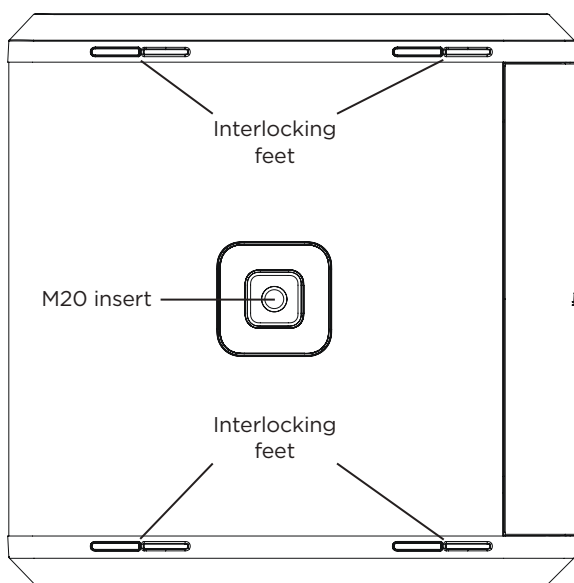

Using the Pole-mount Insert with an S1 Pro

! **WARNING:** The pole-mount M20 threaded insert on the Sub1 and Sub2 is designed to support a pole of up to 1.3 meters (51 inches) with a Bose S1 Pro mounted on the pole. Do not use the Sub1 or Sub2 with a pole exceeding 1.3 meters (51 inches) in height or a loudspeaker weight that exceeds 7.1 kilograms (15.7 pounds). Using a pole/loudspeaker combination that exceeds either of these limits or creates an unstable mounting scenario may lead to a hazardous condition that could result in injury.

The Sub1/Sub2 includes a pole-mount M20 threaded insert. The insert is compatible with the Bose Sub1/Sub2 Adjustable Speaker Pole accessory, designed for use with the Bose S1 Pro system (for more information, see the Adjustable Speaker Pole owner's guide at PRO.BOSE.COM).

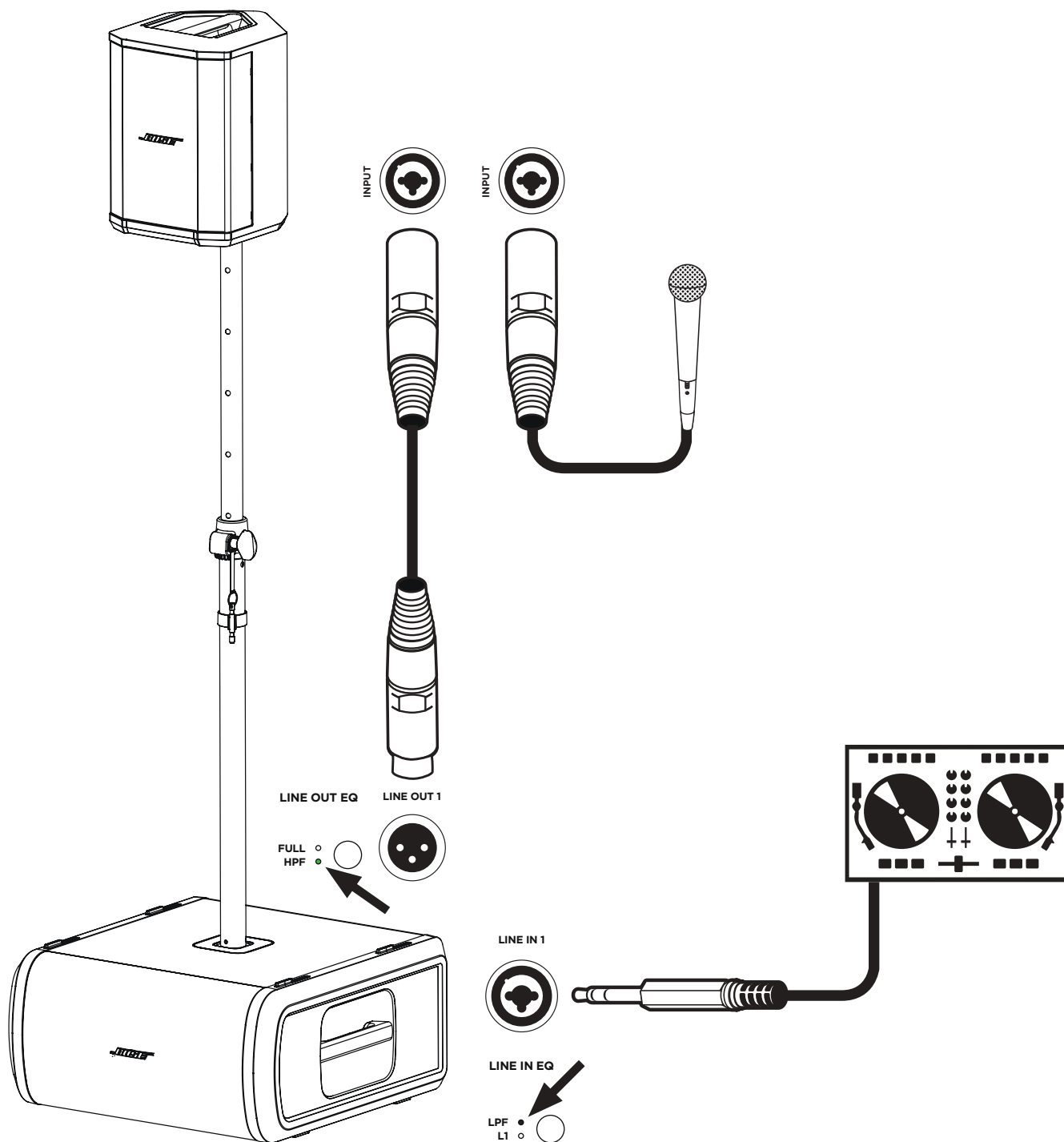

Care & Maintenance

Cleaning Your Sub

Clean the product enclosure using only a soft, dry cloth. If necessary, carefully vacuum the grille of the Sub.

 **CAUTION:** Do not use any solvents, chemicals, or cleaning solutions containing alcohol, ammonia, or abrasives.

CAUTION: Do not use any sprays near the product or allow liquids to spill into any openings.

Troubleshooting

Problem	What to do
No power	<ul style="list-style-type: none"> Make sure you have power at the AC outlet. Try operating a lamp or other equipment from the same AC outlet or test the outlet using an AC outlet tester. If powered from an L1 Pro32 with a SubMatch cable, ensure the L1 Pro32 is turned on, and not in AutoOff/Low-power Standby mode.
No sound	<ul style="list-style-type: none"> Make sure your Sub is turned on. Make sure your source is plugged into the Line Input. Make sure the volume is turned up on your source. Make sure the Level Control is turned up on the Sub. Make sure the Sub isn't in AutoOff/Low-power Standby mode.
Standby LED is flashing red (thermal fault)	<ul style="list-style-type: none"> Turn off the Sub and wait 30 minutes before turning it back on. Move the Sub to a cooler location. Move the Sub to a location that has more ventilation.
Standby LED is solid red (system fault)	<ul style="list-style-type: none"> Contact Bose customer service. Visit worldwide.bose.com/contact.
With nothing plugged into the Sub, a light hum or buzz is heard	<ul style="list-style-type: none"> Using an AC outlet tester, test the AC outlet the Sub is plugged into for reversed or open (hot, neutral, and/or ground) contacts. If using an extension cord, plug the Sub directly into the outlet.
Audio source sounds distorted	<ul style="list-style-type: none"> Turn down volume on the source. Turn down Level Control. Try a different source.
Excessive hum when daisy-chaining multiple units	<ul style="list-style-type: none"> Ensure the level on the daisy-chained unit(s) is not set too high.



853574-0010

©2020 Bose Corporation, All rights reserved.
Framingham, MA 01701-9168 USA
www.Bose.com
AM853574 Rev. 01
October 2020

