

# RoomMatch® Utility RMU208

## small-format foreground/fill loudspeaker



### Key Features

**Award-winning RoomMatch sound** – now in smaller 2-way point-source designs for high-level foreground music, under-balcony, zone-fill and vocal-range floor monitor applications

**Bose EMB2 compression driver** – for lower distortion and improved vocal clarity compared to conventional foreground/fill models; also provides consistent mid/high sonic character compared to that of RoomMatch full-range and other RoomMatch Utility models

**90° x 60° constant-directivity high-frequency horn** – gives wide, even coverage and may be rotated in enclosure

**2 x Bose LF8 8-inch woofer** – with 2.0-inch extended-excursion voice coil extends response to 70 Hz for lowest vocal range

**Quasi-3-way passive crossover with separate filters for each transducer** – provides more consistent frequency and polar response compared to conventional crossover designs

**70 Hz – 16 kHz frequency response and 126 dB maximum peak SPL** – deliver the performance required for most demanding applications

**Flexible mounting with included U-bracket** – rear enclosure panel also includes 4 x M8 threaded inserts in 5.0" x 2.75" (127mm x 70mm) pattern to accept third-party accessory mounting brackets

### Product Overview

The RoomMatch Utility RMU208 small-format sound reinforcement loudspeaker is intended for use in high-quality foreground music, under-balcony, zone fill and vocal-range floor monitor applications. The design features a single Bose® EMB2 compression driver to provide mid/high frequency voicing similar to that of RoomMatch full-range array modules. Dual 8-inch woofers provide full-range output and a multi-angle enclosure increases mounting flexibility.



TECHNICAL DATA SHEET

### Technical Specifications

System Performance		
Frequency Response (+/-3 dB) <sup>1</sup>	80 Hz - 16 kHz	
Frequency Range (-10 dB)	70 Hz - 16 kHz	
Recommended High-Pass Protection Filter	70 Hz with minimum 12-dB/octave filter	
Nominal Coverage Pattern (H x V)	90° x 60° (rotatable high frequency horn)	
Crossover Type	passive; separate bandpass filters per transducer	
	<b>Bose extended-lifecycle test<sup>4</sup></b>	<b>AES transducer test<sup>5</sup></b>
Power Handling, long-term continuous	300 W	400 W
Power Handling, Peak	1200 W	1600 W
Sensitivity (SPL / 1 W @ 1 m) <sup>2</sup>	94 dB	94 dB
Calculated Maximum SPL @ 1 m <sup>3</sup>	119 dB	120 dB
Calculated Maximum SPL @ 1 m, peak	125 dB	126 dB
Transducers		
Low Frequency	2 x Bose LF8 high-excursion 8-inch woofers (2-inch voice coil)	
High Frequency	1 x Bose EMB2 extended-midband high-frequency compression driver (2-inch voice coil)	
Nominal Impedance	8 Ω	
Physical		
Finish	Two-part spray polyurethane coating, black or white	
Grille	18-gauge (1.2 mm) perforated steel, powder-coated finish, black or white	
Environmental	Indoor use only	
Connectors	2 x Neutrik® NL4 and 1 x barrier strip, wired parallel	
Suspension / Mounting	2 x M8 threaded inserts (1 each side) for U-bracket; 2 x M8 threaded inserts (1 each side) for vertical yoke mount, 4 x M8 threaded inserts on rear surface (127 x 70 mm, 4-bolt pattern)	
Dimensions (Enclosure only)	9.3" H x 27.0" W x 10.5" D (236 mm H x 686 mm W x 267 mm D)	
Net Weight	37 lbs (16.8 kg) / 43 lbs (19.5 kg) with U-bracket	
Shipping Weight	49 lbs (22.2 kg)	
Product Code		
Black	371836-0120	
White	371836-0220	

# RoomMatch® Utility RMU208

small-format foreground/fill loudspeaker



**Footnotes:**

- 1 Frequency response and range measured on-axis with passive crossover in an anechoic environment.
- 2 Sensitivity measured in half-space boundary conditions with passive EQ, referenced to 1W/m.
- 3 Maximum SPL calculated from sensitivity and power handling specifications, exclusive of power compression.
- 4 Bose extended-lifecycle test using pink noise filtered to meet IEC268-5, 6-dB crest factor, 500-hour duration.
- 5 AES standard 2-hour duration with IEC system noise.

TECHNICAL DATA SHEET

# RoomMatch® Utility RMU208

small-format foreground/fill loudspeaker



## Directivity Index and Q

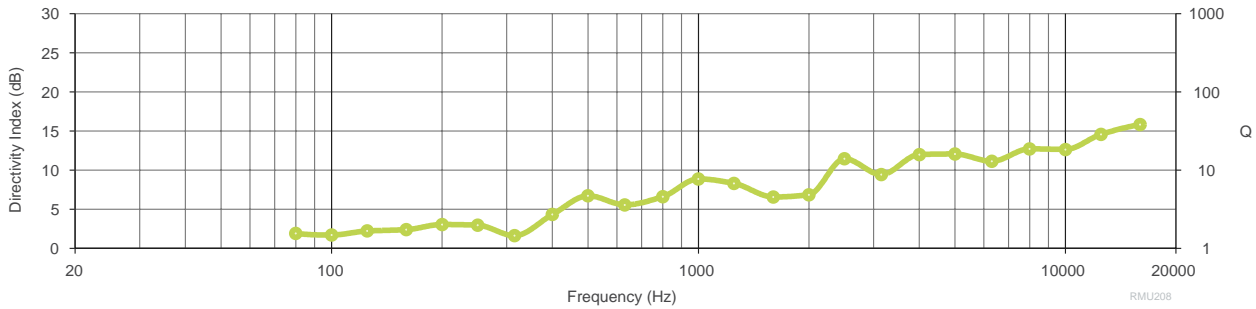

## Beamwidth

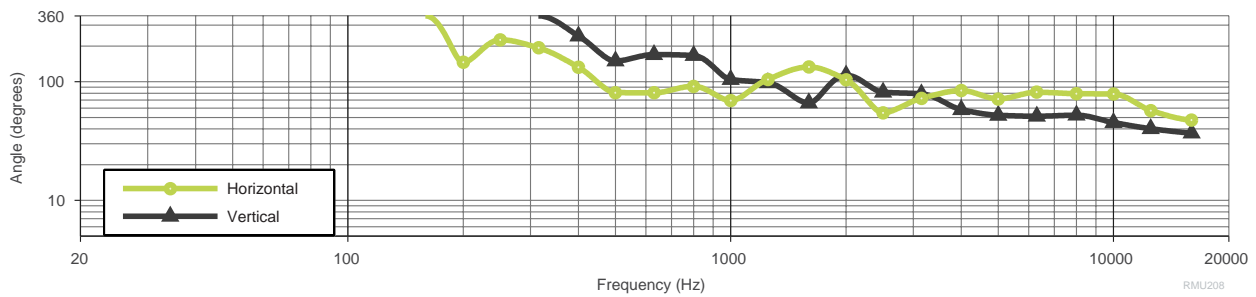

## Impedance

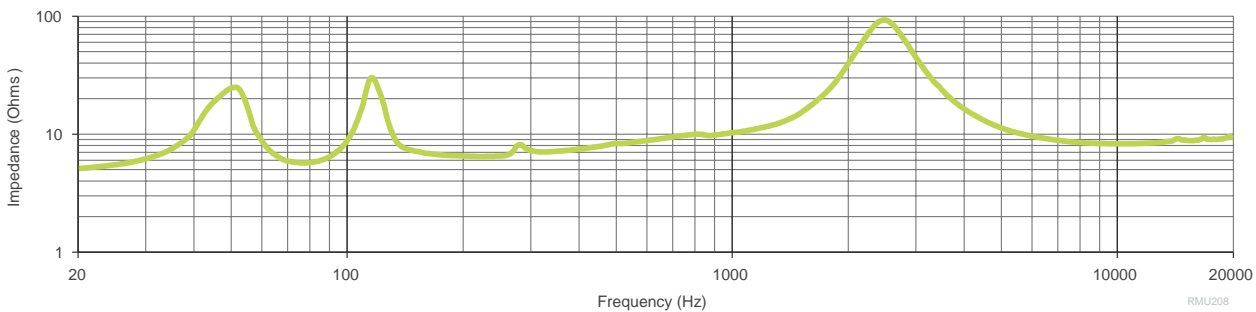

## On-Axis Response

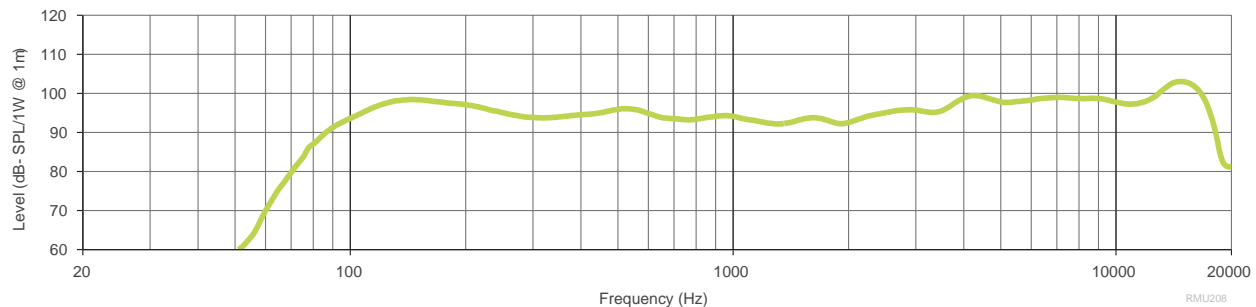

# RoomMatch® Utility RMU208

small-format foreground/fill loudspeaker



## Wiring Diagram

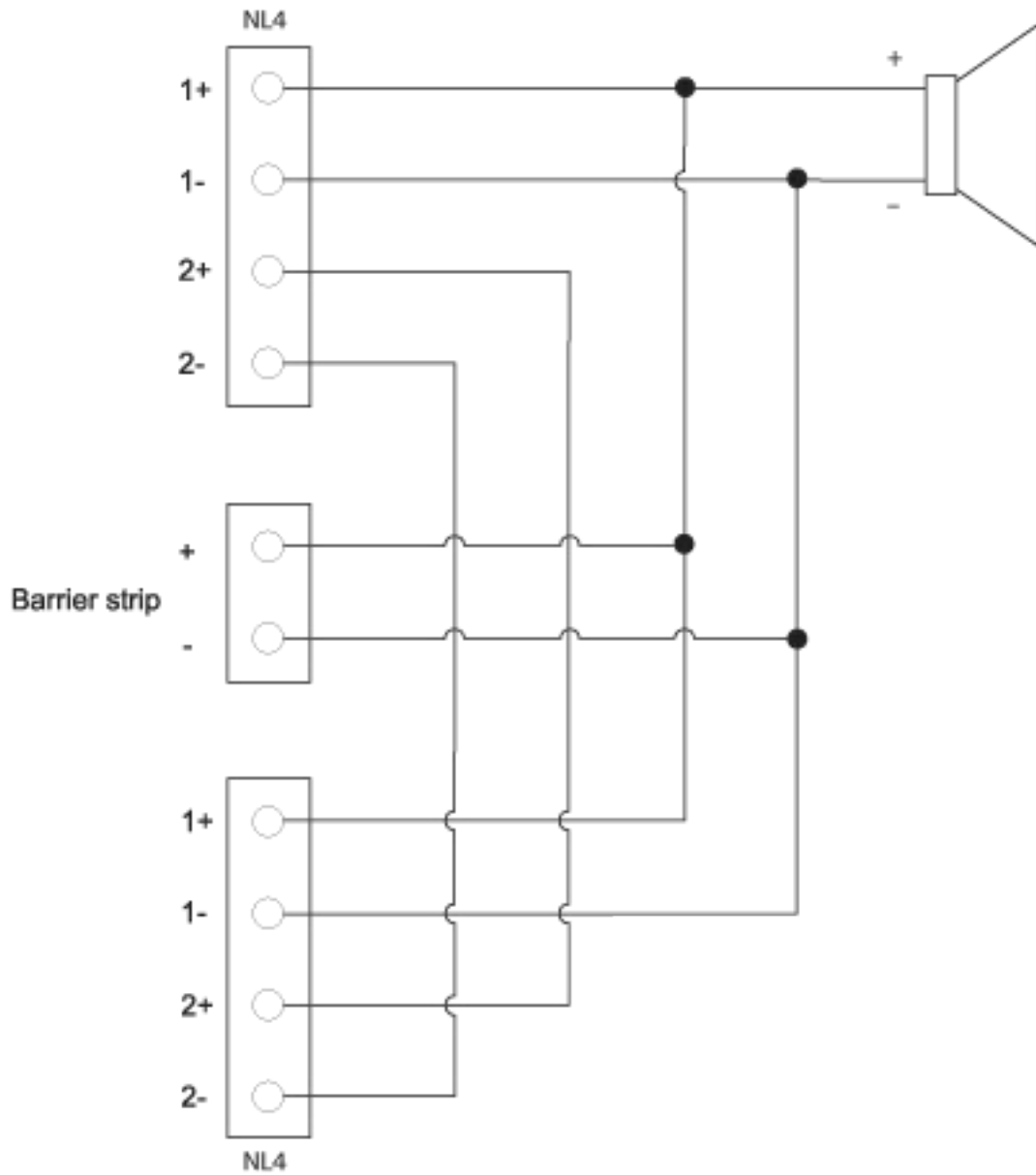

TECHNICAL DATA SHEET

# RoomMatch® Utility RMU208

small-format foreground/fill loudspeaker



## Mechanical Diagrams

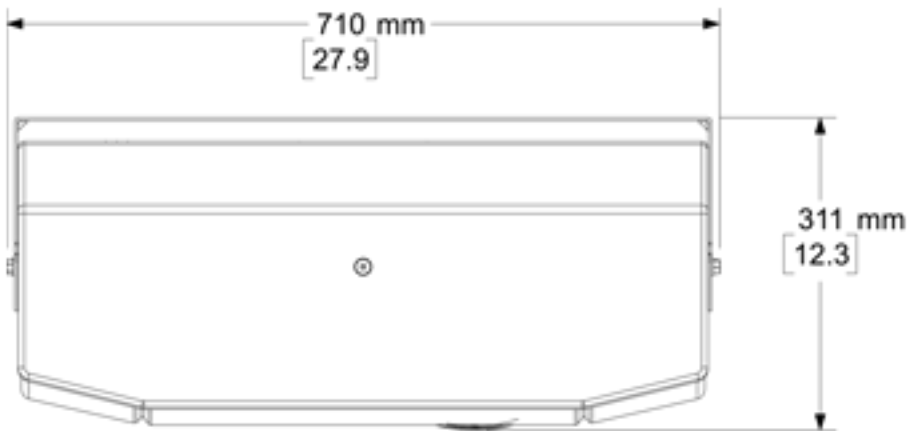

Top View



Front View

Right View

# RoomMatch® Utility RMU208

small-format foreground/fill loudspeaker



## Horizontal Plots

TECHNICAL DATA SHEET

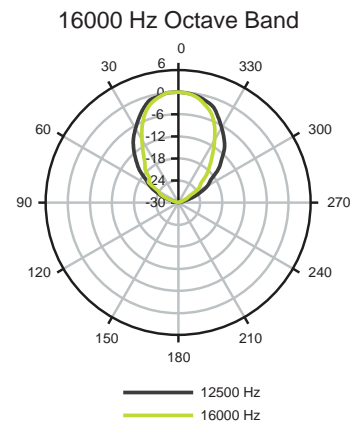
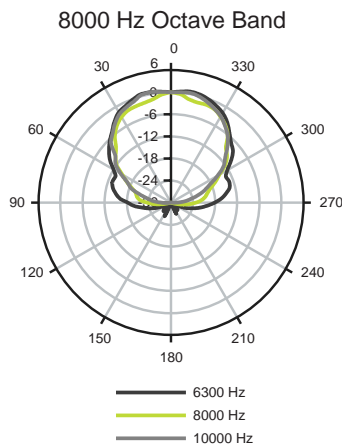
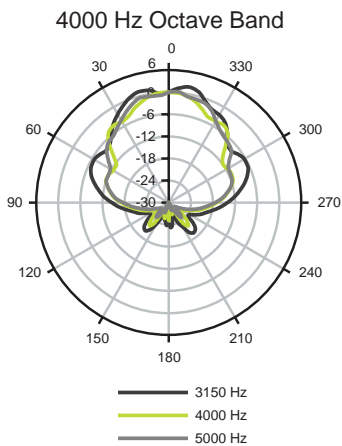
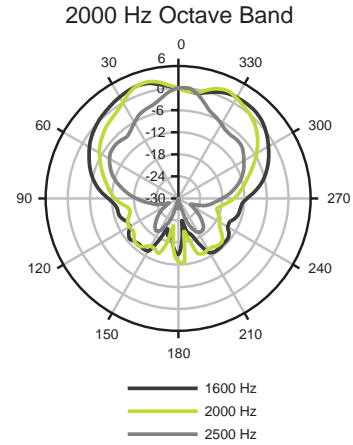
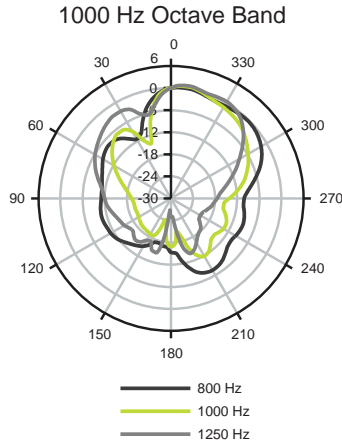
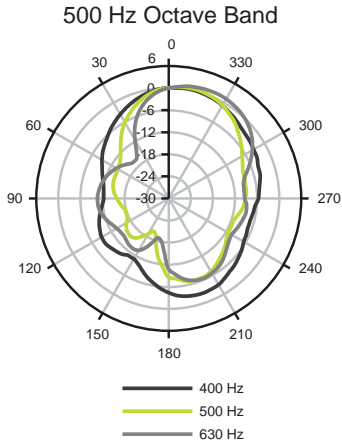
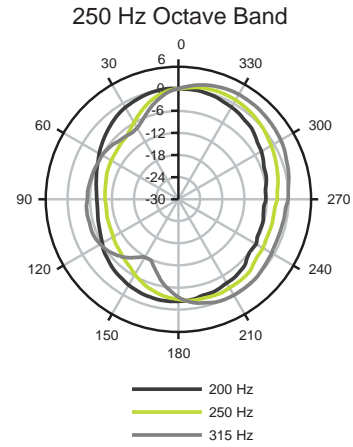
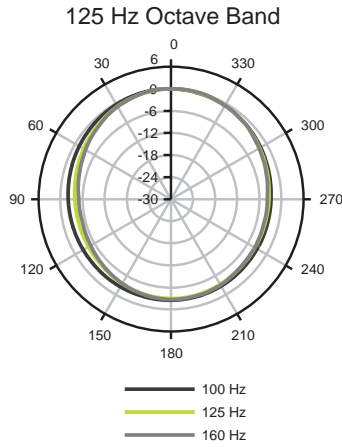
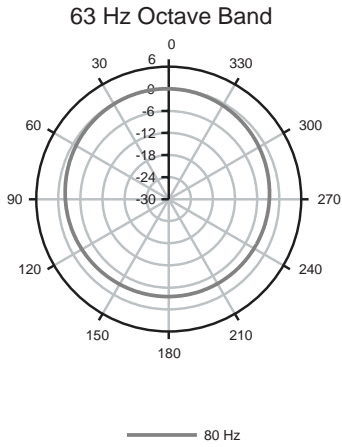

# RoomMatch® Utility RMU208

small-format foreground/fill loudspeaker



## Vertical Plots

TECHNICAL DATA SHEET

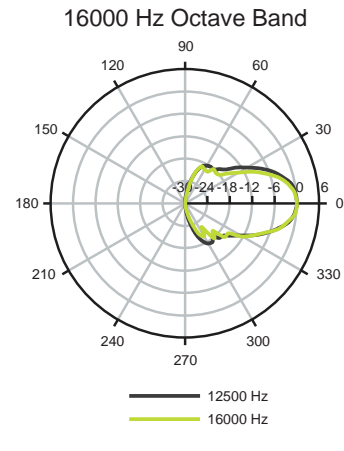
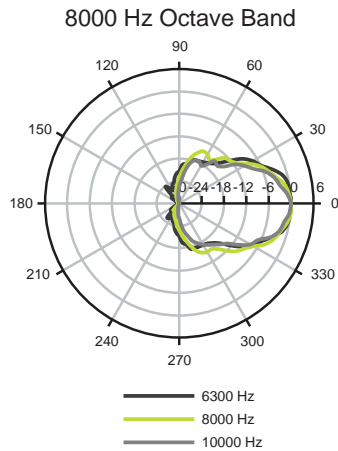
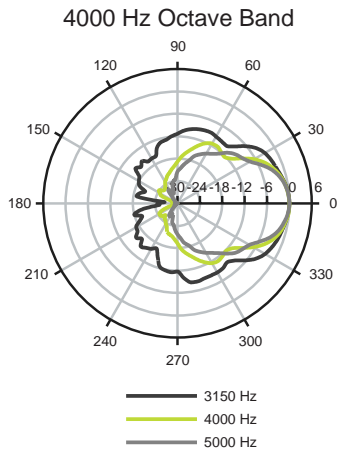
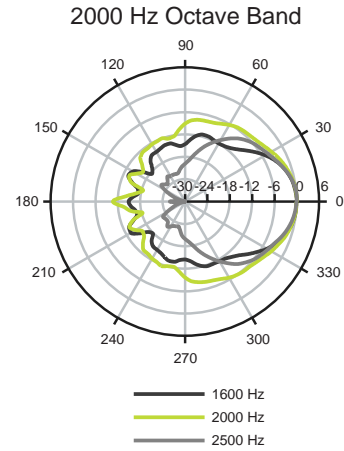
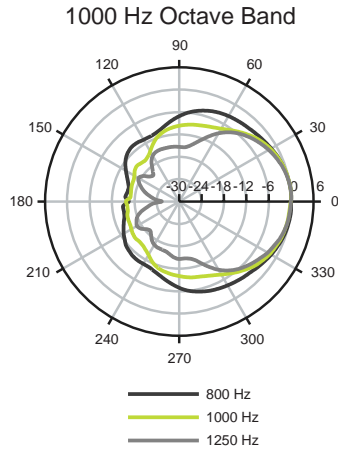
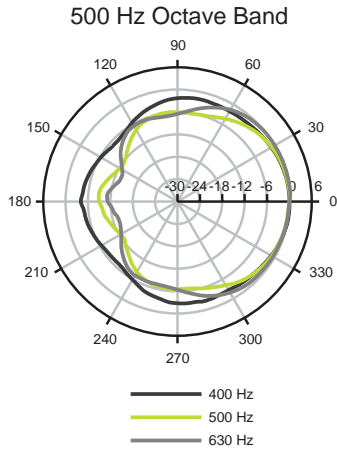
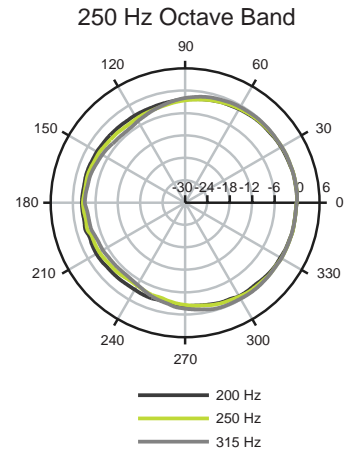
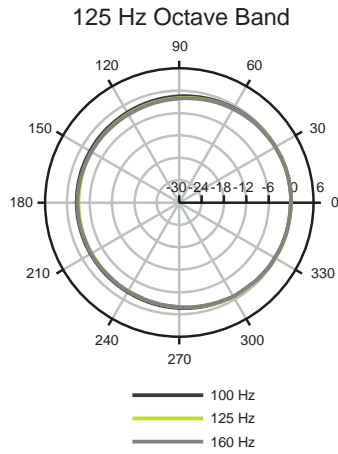
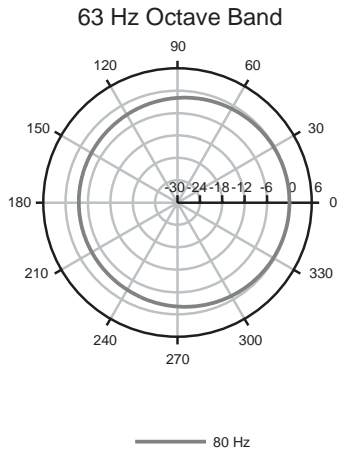

# RoomMatch® Utility RMU208

## small-format foreground/fill loudspeaker



### Architects' and Engineers' Specifications

The 2-way, full-range loudspeaker shall contain a single 2-inch titanium-diaphragm compression driver and two (2) 8-inch cone transducers with 2-inch voice coils. The loudspeaker shall contain a quasi-3-way passive crossover network in which each woofer and compression driver have separate networks with 200 Hz low-pass filter applied to one woofer, 1200 Hz low-pass filter applied to the other woofer, and 1200 Hz high-pass filter applied to the compression driver. The passive network will provide a consistent coverage pattern and frequency response near crossover region.

The 2-way, full-range loudspeaker shall meet the following performance specifications: On-axis system frequency response shall be 80 Hz to 16 kHz (+/- 3 dB) without need for active equalization. The loudspeaker sensitivity shall be 94dB SPL in free field with 1 W input at 1 meter. The long-term power handling rating shall be 400 W (AES test methodology using pink noise, 6 dB crest factor, 2-hour duration). Maximum continuous output shall be 120 dB SPL and the maximum peak output shall be 126 dB SPL, both in free field. The nominal coverage pattern of the high-frequency horn shall be 90° horizontal and 60° vertical, with the horn capable of being rotated 90° in the enclosure by the installer.

The loudspeaker enclosure shall be constructed of Baltic birch plywood, protected by a two-part polyurethane coating. The multi-angle enclosure will allow placement on floors with an approximate 45° acoustic axis referenced to the floor surface. The transducers shall be protected by a 1.5-mm perforated steel grille with powder-coated finish. Input connectors shall be two (2) Neutrik® NL4 Speakon® connectors and one barrier strip terminal, wired in parallel. The finish will be available in black or white (paintable). Loudspeaker dimensions shall be 9.3" x 27.0" x 10.5" (236 x 686 x 267 mm) and net weight shall be 36 lb. (16.3 kg). The loudspeaker shall be the Bose RoomMatch Utility RMU208 model.