

***BOSE***<sup>®</sup>

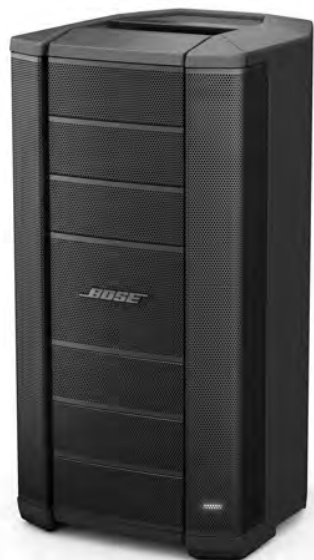

# F1 Flexible Array Loudspeaker System

F1 Model 812 and F1 Subwoofer

Owner's Guide

**BOSE PROFESSIONAL**

[pro.bose.com](http://pro.bose.com)

# Important Safety Instructions

Please read this owner's guide carefully and save it for future reference.

## WARNINGS:

- To reduce the risk of fire or electrical shock, do not expose the product to rain or moisture.
- Do not expose this apparatus to dripping or splashing, and do not place objects filled with liquids, such as vases, on or near the apparatus. As with any electronic products, use care not to spill liquids into any part of the system. Liquids can cause a failure and/or a fire hazard.
- Do not place any naked flame sources, such as lighted candles, on or near the apparatus.



The lightning flash with arrowhead symbol within an equilateral triangle alerts the user to the presence of uninsulated dangerous voltage within the system enclosure that may be of sufficient magnitude to constitute a risk of electrical shock.



The exclamation point within an equilateral triangle, as marked on the system, is intended to alert the user to the presence of important operating and maintenance instructions in this owner's guide.



This product contains magnetic material. Please contact your physician if you have any questions on whether this might affect the operation of your implantable medical device.



Contains small parts which may be a choking hazard. Not suitable for children under age 3.

## CAUTIONS:

- This product shall be connected to a mains socket outlet with a protective earthing connection.
- Do not make unauthorized alterations to the product; doing so may compromise safety, regulatory compliance, system performance, and may void the warranty.

## Notes:

- Where the mains plug or appliance coupler is used as the disconnect device, such disconnect device shall remain readily operable.
- The product must be used indoors. It is neither designed nor tested for use outdoors, in recreational vehicles, or on boats.



This product conforms to all applicable EU directive requirements. The complete Declaration of Conformity can be found at [www.Bose.com/compliance](http://www.Bose.com/compliance).



This symbol means the product must not be discarded as household waste, and should be delivered to an appropriate collection facility for recycling. Proper disposal and recycling helps protect natural resources, human health and the environment. For more information on disposal and recycling of this product, Contact your local municipality, disposal service, or the shop where you bought this product.

**NOTE:** This equipment has been tested and found to comply with the limits for a Class A digital device, pursuant to part 15 of the FCC Rules. These limits are designed to provide reasonable protection against harmful interference when the equipment is operated in a commercial environment. This equipment generates, uses, and can radiate radio frequency energy and, if not installed and used in accordance with the instruction manual, may cause harmful interference to radio communications. Operation of this equipment in a residential area is likely to cause harmful interference in which case the user will be required to correct the interference at their own expense.

This Class A digital apparatus complies with Canadian ICES-003.

Changes or modifications not expressly approved by Bose Corporation could void the user's authority to operate this equipment.

1. Read these instructions.
2. Keep these instructions.
3. Heed all warnings.
4. Follow all instructions.
5. Do not use this apparatus near water.
6. Clean only with a dry cloth.
7. Do not block any ventilation openings. Install in accordance with the manufacturer's instructions.
8. Do not install near any heat sources, such as radiators, heat registers, stoves or other apparatus (including amplifiers) that produce heat.
9. Do not defeat the safety purpose of the polarized or grounding-type plug. A polarized plug has two blades with one wider than the other. A grounding type plug has two blades and a third grounding prong. The wide blade or the third prong are provided for your safety. If the provided plug does not fit into your outlet, consult an electrician for replacement of the obsolete outlet.
10. Protect the power cord from being walked on or pinched, particularly at plugs, convenience receptacles, and the point where they exit from the apparatus.
11. Only use attachments/accessories specified by the manufacturer.
12. Use only with the cart, stand, tripod, bracket, or table specified by the manufacturer, or sold with the apparatus. When a cart is used, use caution when moving the cart/apparatus combination to avoid injury from tip-over.
13. Unplug this apparatus during lightning storms or when unused for long periods of time.
14. Refer all servicing to qualified service personnel. Servicing is required when the apparatus has been damaged in any way: such as power supply cord or plug is damaged; liquid has been spilled or objects have fallen into the apparatus; the apparatus has been exposed to rain or moisture, does not operate normally, or has been dropped.



## For Japan only:

Provide an earth connection before the main plug is connected to the mains.

## For Finland, Norway, and Sweden:

- In Finnish: "Laitte on liitettävä suojamaadoituskoskettimilla varustettuun pistorasiaan"
- In Norwegian: "Apparatet må tilkoples jordet stikkontakt"
- In Svenska: "Apparaten skall anslutas till jordat uttag"

## For China only:

**CAUTION:** Only suitable for use at areas with altitude less than 2000m.

## Please complete and retain for your records

Now is a good time to record the serial numbers of your product. Serial numbers can be found on the rear panel. You can register your product online at [www.Bose.com/register](http://www.Bose.com/register) or by calling 877-335-2673. Failure to do so will not affect your warranty rights.

F1 Model 812 Loudspeaker \_\_\_\_\_

F1 Subwoofer \_\_\_\_\_

# Contents

---

## Introduction

Product Description .....	4
Features and Benefits .....	4
Carton Contents .....	4
F1 Model 812 Flexible Array Loudspeaker.....	5
F1 Subwoofer.....	5
Using the Flexible Array .....	6
Adjusting the array.....	6
Four coverage patterns.....	6
Applications .....	7

## Setting Up the System

Using the F1 Model 812 with the F1 Subwoofer.....	8
Using the F1 Model 812 on a Tripod Stand.....	9

## Operation

F1 Model 812 Control Panel.....	10
F1 Subwoofer Control Panel .....	11
Power On/Off Sequence .....	12
Setting EQ selector switches .....	12
Connecting Sources.....	12
Setting Up INPUT 1 with a Microphone.....	12
Setting Up INPUT 1 with a Source .....	12
Setting Up INPUT 2 with a Source .....	12
Connection Scenarios.....	13
Full band, mixing console stereo output to L/R F1 Model 812 Loudspeakers.....	13
Full band with mixing console, one F1 Subwoofer and two F1 Model 812 Loudspeakers.....	13
Mixing console stereo output to F1 Subwoofer and left/right F1 Model 812 Loudspeakers .....	14
Stereo input to Left/right F1 Subwoofers and F1 Model 812 Loudspeakers .....	15
Mic to F1 Model 812 Loudspeaker INPUT 1 .....	16
Mobile device to single F1 Model 812 Loudspeaker.....	16
Mobile device to F1 Flexible Array Loudspeaker system .....	17
Mobile device to F1 Model 812 Loudspeaker and F1 Subwoofer.....	17
DJ Console to two F1 Subwoofers and two F1 Model 812 Loudspeakers.....	18

## Care and Maintenance

Caring for Your Product.....	19
Cleaning.....	19
Getting Service .....	19
Troubleshooting.....	19
LED Indicators.....	20
Limited Warranty and Registration .....	20
Accessories .....	20
Technical Information .....	21
Physical.....	21
Electrical .....	21
Input/Output Connector Wiring Reference .....	21

# Introduction

---

## Product Description

---

The Bose® F1 Model 812 Flexible Array Loudspeaker is the first powered portable loudspeaker that lets you control its vertical coverage pattern. Simply push or pull the array into position to create “Straight,” “C,” “J” or “Reverse J” coverage patterns. And once set, the system automatically changes the EQ to maintain optimum tonal balance for each coverage pattern. So whether you’re playing at floor level, on a stage, or facing raked seats or bleachers, you can now adapt your PA to match the room.

Engineered with an array of eight high-output mid/high drivers, a high-powered 12" woofer and a lower crossover point, the loudspeaker delivers high SPL performance while maintaining vocal and midrange clarity that’s dramatically better than conventional loudspeakers.

For extended bass response, the Bose F1 Subwoofer packs all the power of a larger bass box into a more compact design that’s easier to carry and fits in a car. A mounting stand for the loudspeaker is integrated right into the body of the subwoofer, so you always know where it is, making setup fast and easy. The stand even includes cable channels to neatly hide the wires.

The loudspeaker and subwoofer each have 1,000 watts of power, so you can fill nearly any venue with sound.

And now getting there is easier, too. The loudspeaker and subwoofer feature light weight, high impact composite materials and strategically placed handles for easy transport.

For the first time, the F1 Model 812 Loudspeaker allows you to focus sound where it’s needed. So no matter where you perform, your PA has you covered.

## Features and Benefits







---

- The flexible, eight-loudspeaker array of the F1 Model 812 allows you to select one of four coverage patterns to direct sound to where the audience is located resulting in better overall clarity throughout the venue.
- The vertical orientation of the eight-driver loudspeaker array helps deliver wide, consistent sound coverage, providing better clarity and tonal balance for speech, music, and instruments.
- F1 Subwoofer provides a unique built-in speaker stand for the F1 Model 812, eliminating the need for a conventional pole mount.
- Attractive design creates a unique system with a rugged but professional look.
- The bi-amplified design includes powerful, lightweight amplifiers that provide consistent output over long durations with extended dynamic range and lower operating temperatures.

## Carton Contents

---

Each loudspeaker is packaged separately with the items indicated below.

<b>F1 Model 812 Flexible Array Loudspeaker</b>	<b>F1 Subwoofer</b>
  <p>AC power cord*</p>  <p>Owner's Guide</p> <p>F1 Model 812 Loudspeaker</p>	  <p>AC power cord*</p>  <p>Owner's Guide</p> <p>F1 Subwoofer with built-in stand</p>

\*The appropriate power cord(s) for your region is included.

## F1 Model 812 Flexible Array Loudspeaker

**Note:** The F1 Model 812 comes with threaded M8 inserts for rigging or attaching accessory brackets.

**CAUTION:** Only professional installers with the knowledge of proper hardware and safe mounting techniques should attempt to install any loudspeaker overhead.

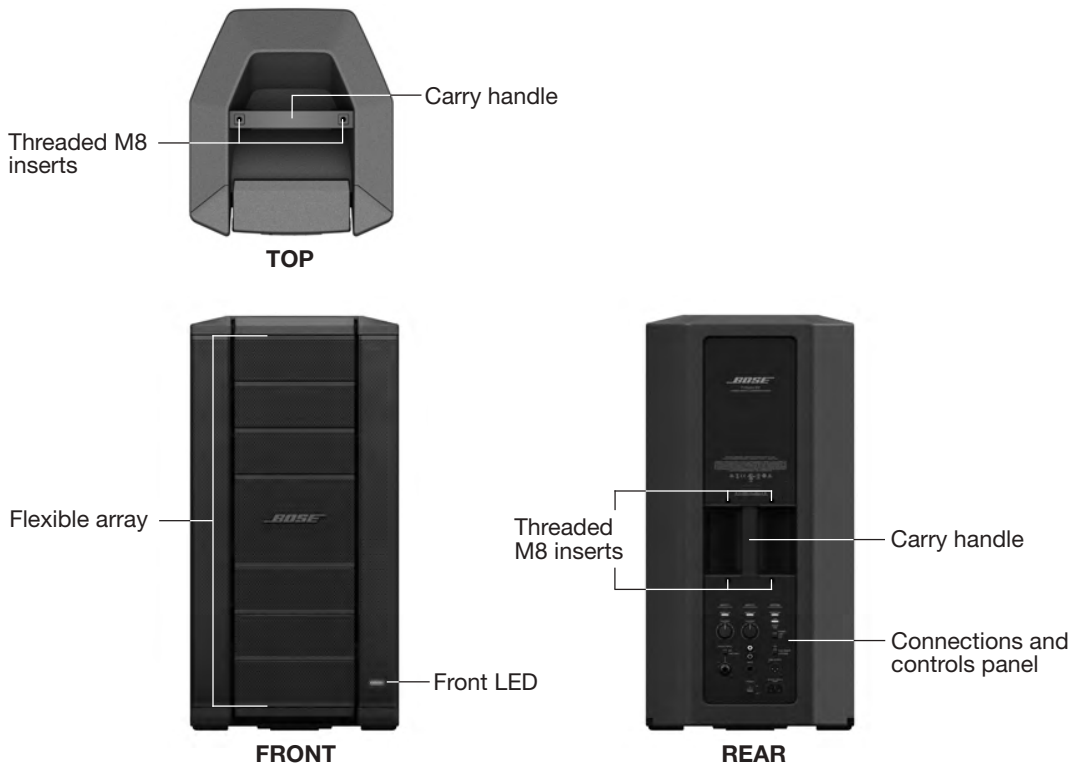

## F1 Subwoofer



# Introduction

---

## Using the Flexible Array

---

You can shape the coverage pattern by moving the position of the top and bottom array. The array position is held in place by magnets that trigger internal sensors that adjust EQ according to array shape.

### Adjusting the array

**Pushing the array in**



**Pulling the array out**



### Four coverage patterns

**Straight pattern**

Pull top and bottom array out

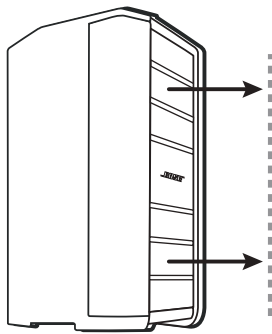

**J pattern**

Pull top array out, push bottom array in.

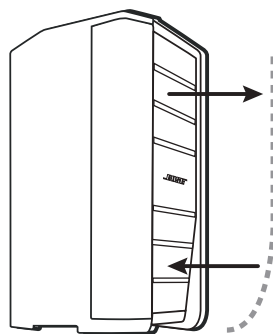

**Reverse-J pattern**

Push top array in, pull bottom array out.

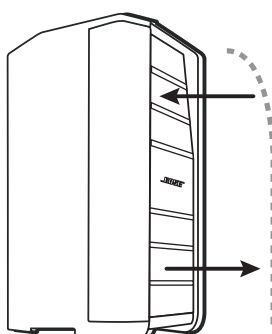

**C pattern**

Push top and bottom array in.

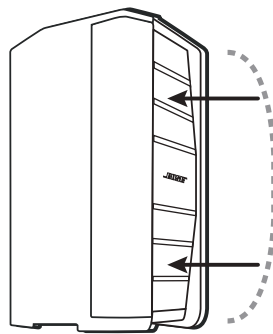

## Applications

### Straight pattern

Use the straight pattern when the audience is standing and their heads are approximately at the same height as the loudspeaker.

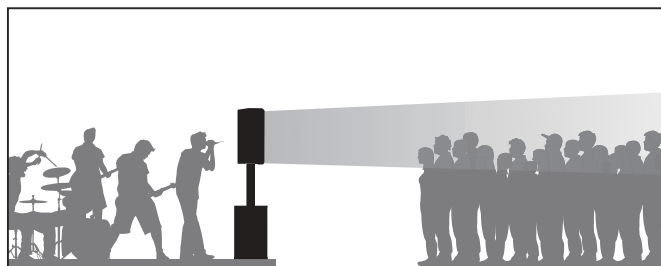
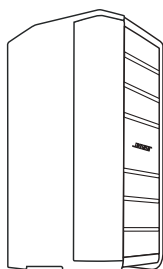

### Reverse-J pattern

The reverse-J pattern is good for an audience in raked seating that starts at loudspeaker height and extends above the top of the loudspeaker.

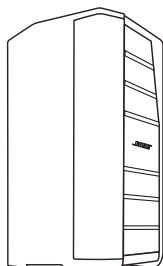

### J pattern

The J pattern works well when the loudspeaker is up on a raised stage and the audience is seated below on the floor.

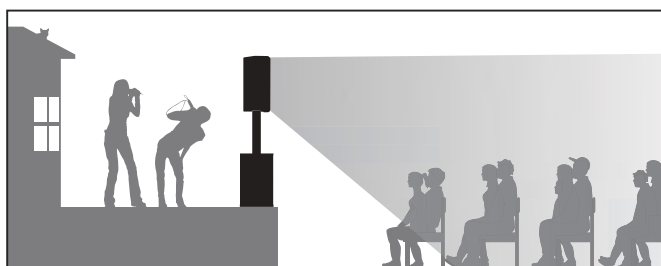
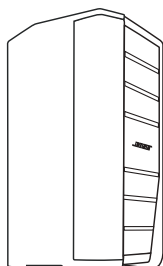

### C pattern

Use the C pattern for raked seating in an auditorium when the first row is on the floor with the loudspeaker.

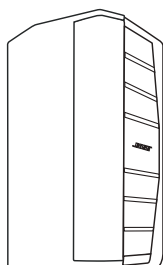

## Setting Up the System

---

### Using the F1 Model 812 with the F1 Subwoofer

---

The built-in loudspeaker stand is stored in the rear of the subwoofer. Setting up the F1 Model 812 Loudspeaker with the F1 Subwoofer is easy:

1. Remove the built-in speaker stand from the back of the F1 Subwoofer and insert it into the stand slots.



2. Lift the F1 Model 812 Loudspeaker and place it on the stand.





3. Plug in your audio cables. Feed the cables from the F1 Model 812 through the channels in the speaker stand to help keep them organized.

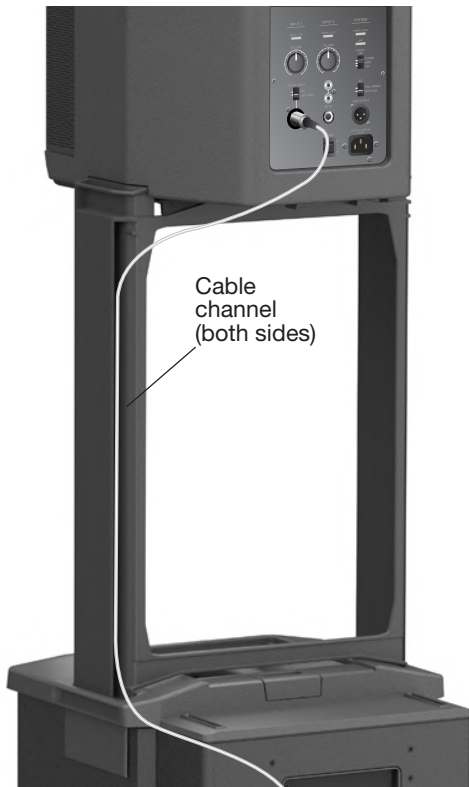

### Using the F1 Model 812 on a Tripod Stand

The bottom of the F1 Model 812 Loudspeaker includes pole cup for mounting the loudspeaker on a tripod speaker stand. The pole cup fits a standard 35 mm post.

**WARNING:** Do not use the F1 Model 812 Loudspeaker with a tripod stand that is unstable. The loudspeaker is only designed for use on a 35 mm pole, and the tripod stand must be capable of supporting a loudspeaker with a minimum weight of 44.5 lb (20.2 Kg) lbs and an overall size of 26.1" H x 13.1" W x 14.6" D (665 mm H x 334 mm W x 373 mm D) inches (mm). Using a tripod stand that is not designed to support the size and mass of the F1 Model 812 Loudspeaker may lead to an unstable and hazardous condition that could result in injury.

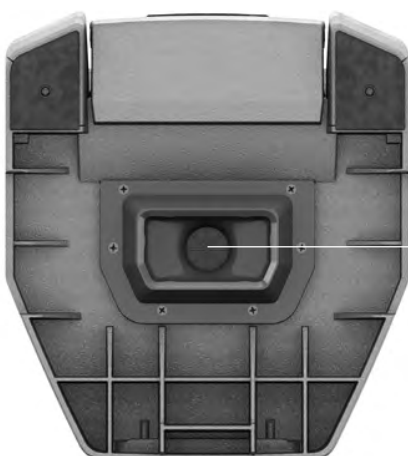

Pole cup fits a standard 35 mm tripod stand



## F1 Model 812 Control Panel

**Note:** For a complete list of LED indications and behaviors, see “LED Indicators” on page 20.

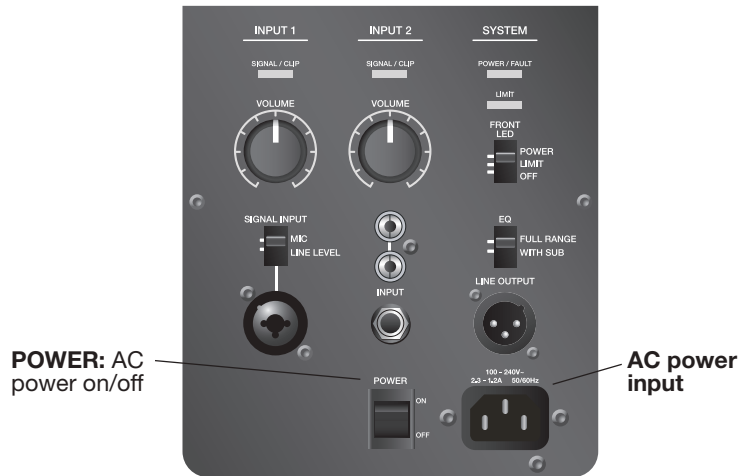

**POWER:** AC power on/off

**AC power input**

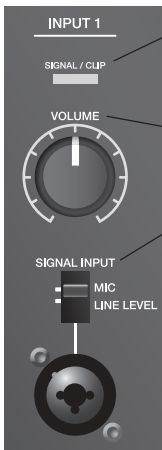

**SIGNAL/CLIP:** Displays the input signal status in color.

- Green = signal present.
- Red = signal clipping, input signal too high

**VOLUME:** Adjusts channel volume.

**SIGNAL INPUT:** Selector switch sets input sensitivity for input type. Combo connector accepts XLR mic connector or 1/4" phone plug (TRS balanced or TS unbalanced cables).

- **MIC** selects sensitivity for microphone inputs (dynamic or self-powered mics only) – use only when a mic is connected directly to the input.
- **LINE** selects sensitivity for line-level inputs, for example, from a mixing console or DJ controller.



**SIGNAL/CLIP:** Displays the input signal status in color.

- Green = signal present.
- Red = signal clipping, input signal too high.

**VOLUME:** Adjusts channel volume.

**RCA connectors:** Analog stereo input for audio sources such as DJ controllers and other line-level sources. Left and right are summed, producing a mono audio output and mono signal to LINE OUTPUT (XLR).

- Left (White)
- Right (Red)

**1/4" phone connector:** Provides analog input for guitars and other instruments. Accepts TRS balanced or TS unbalanced cables.

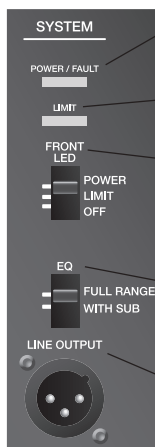

**POWER/FAULT:**

- Blue = power on.
- Red = fault condition.

**LIMIT:**

- Amber = system limiting (protection mode).

**FRONT LED:**

- **POWER** enables front LED to indicate power status.
- **LIMIT** engages a limiting display on the front LED.
- **OFF** turns off the front LED.

**EQ:** (See “Power On/Off Sequence” on page 12.)

- **FULL RANGE** allows the loudspeaker to function without high-pass filtering.
- **WITH SUB** engages a high-pass filter (100 Hz) when using the loudspeaker with the F1 subwoofer. Recommended when using with F1 Subwoofer.

**LINE OUTPUT:**

- Balanced XLR line output provides a mix of input 1 and 2, post input volume control. Can be used to daisy chain speakers together.

## F1 Subwoofer Control Panel

**Note:** For a complete list of LED indications and behaviors, see “LED Indicators” on page 20.

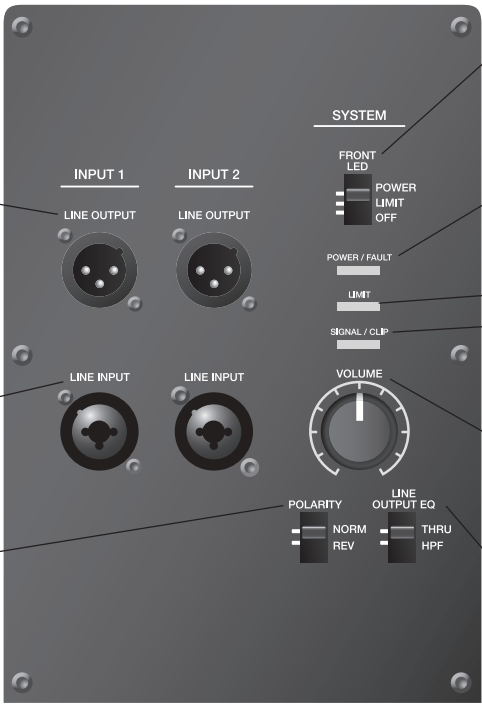

**LINE OUTPUT 1 & 2:**  
Individual outputs that provide balanced line output signals (pre-volume control) that can be sent to powered loudspeakers or additional subwoofers.

**Note:** When the LINE OUTPUT EQ selector switch is set to THRU, the LINE OUTPUT signal will be full range.

**LINE INPUT 1 & 2:**  
Combination XLR – ¼" phone connector inputs that accept line level signals.

**POLARITY:**

- NORM** is used when when the F1 Model 812 loudspeaker is mounted on the supplied stand.
- REV** may be used to better align the bass when the subwoofer is located further away from the F1 Model 812 loudspeaker.

**FRONT LED selector switch:**

- POWER** enables LED to indicate power status.
- LIMIT** enables LED to indicate limiting.
- OFF** turns off LED.

**POWER/FAULT:** indicates power/fault status

- Blue = power on.
- Red = fault condition.

**LIMIT:** Amber = system limiting.

**SIGNAL/CLIP:** Displays the input signal status in color.

- Green = signal present.
- Red = signal clipping - input signal too high.

**VOLUME** – Adjusts subwoofer volume. Middle detent position is 0dB – nominal position when the F1 Model 812 and F1 Subwoofer are connected to a mixing console. Use 0dB position for a line-level signal input.

**LINE OUTPUT EQ:** (See “Power On/Off Sequence” on page 12.)

- THRU** passes input signal to the output with no filtering. Recommended when using with F1 Model 812.
- HPF** passes input through a high-pass (100 Hz) filter. Affects LINE OUTPUT signals only.



AC input connector.

POWER on/off switch.

# Operation

## Power On/Off Sequence

When turning the system on, turn on input sources and mixing consoles first and then turn on the F1 Model 812 Loudspeaker and the F1 Subwoofer. When turning the system off, turn off the F1 Model 812 and F1 Subwoofer first followed by input sources and mixing consoles.

## Setting EQ selector switches

Recommended settings for the EQ selector switches on the F1 Model 812 Loudspeaker and the F1 Subwoofer are describe in the following table.

System Setup	F1 Model 812 EQ Switch	F1 Subwoofer LINE OUTPUT EQ Switch
F1 Model 812 Loudspeaker used without F1 Subwoofer	FULL RANGE	Not applicable
Signal input to F1 Subwoofer, F1 Subwoofer output to F1 Model 812 Loudspeaker	WITH SUB	THRU
Signal input to F1 Model 812 Loudspeaker, F1 Model 812 output to F1 Subwoofer	FULL RANGE or WITH SUB*	No affect

\*Provides more bass extension.

## Connecting Sources

Before plugging in a sound source, turn the VOLUME control of the channel fully counter-clockwise.

The two independent inputs provide a combination of input connectors that can accomodate microphone and line-level sources.

**Note:** Only dynamic or self-powered microphones can be used for INPUT 1.

### Setting Up INPUT 1 with a Microphone

1. Turn the INPUT 1 VOLUME fully counter-clockwise.
2. Set the SIGNAL INPUT switch to MIC.
3. Plug the mic cable into the INPUT 1 connector.
4. Adjust the VOLUME to your desired level.

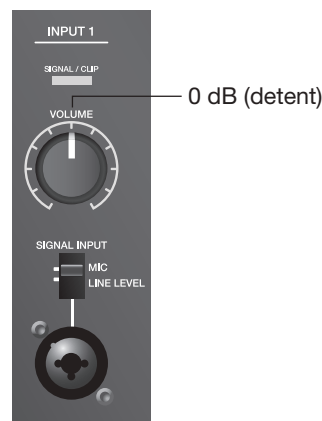

### Setting Up INPUT 1 with a Source

1. Turn the INPUT 1 VOLUME fully counter-clockwise.
2. Set the SIGNAL INPUT switch to LINE LEVEL.
3. Plug the source cable into the INPUT 1 connector.
4. Adjust the VOLUME to your desired level.

### Setting Up INPUT 2 with a Source

1. Turn the INPUT 2 VOLUME fully counter-clockwise.
2. Plug the source cable into an INPUT 2 connector.
3. Adjust the VOLUME to your desired level.

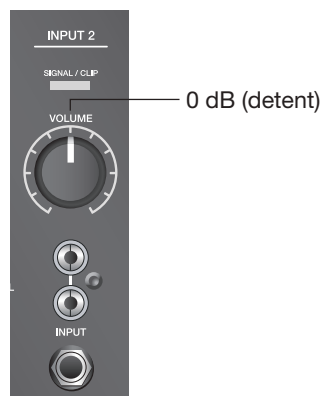

Connection Scenarios

Full band, mixing console stereo output to L/R F1 Model 812 Loudspeakers

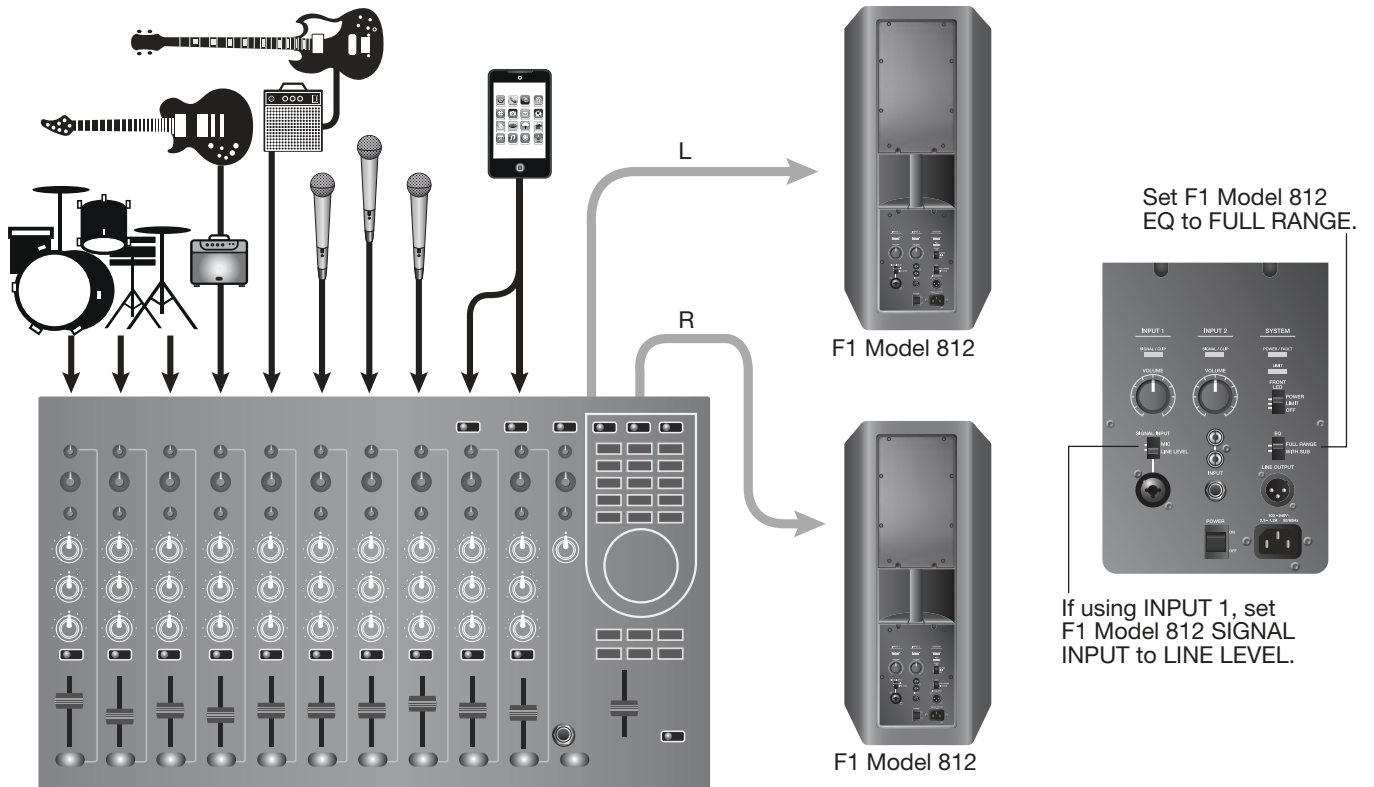

Full band with mixing console, one F1 Subwoofer and two F1 Model 812 Loudspeakers

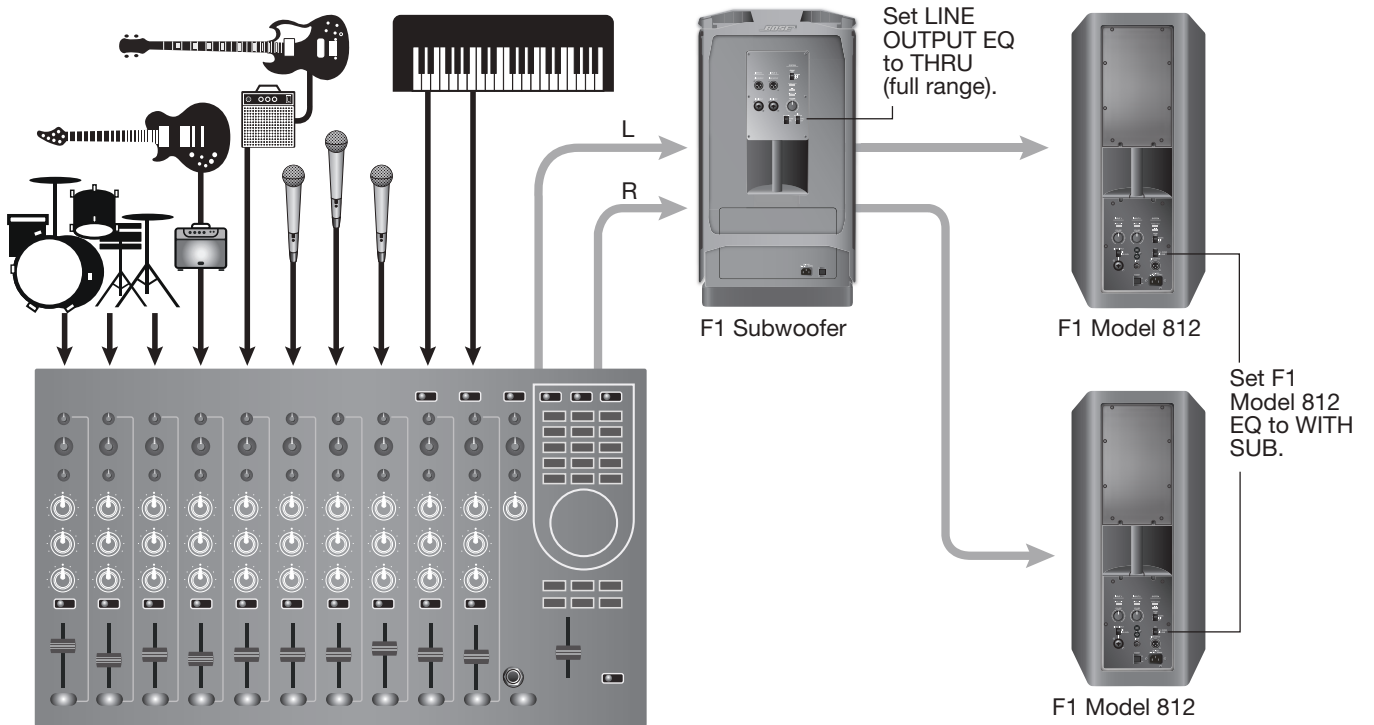

# Operation

## Mixing console stereo output to F1 Subwoofer and left/right F1 Model 812 Loudspeakers

**Note:** The recommend EQ settings are provided under the heading, “Power On/Off Sequence” on page 12. However, for maximum bass response, set the EQ selector switch on both F1 Model 812 Loudspeakers to FULL RANGE and set the EQ selector switch on the F1 Subwoofer to THRU.

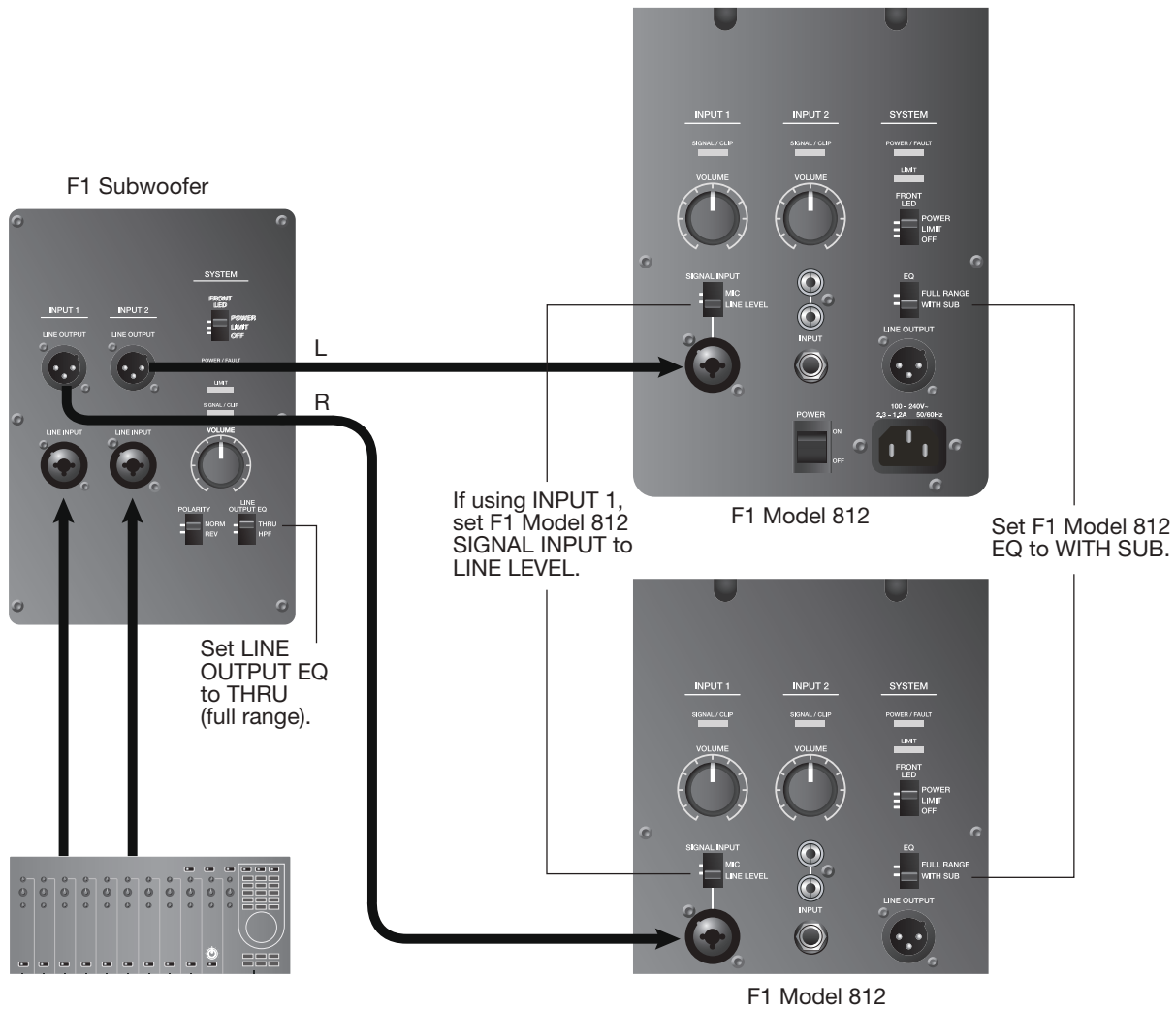

**Full band with mixing console stereo output to two F1 Subwoofers and two F1 Model 812 Loudspeakers**

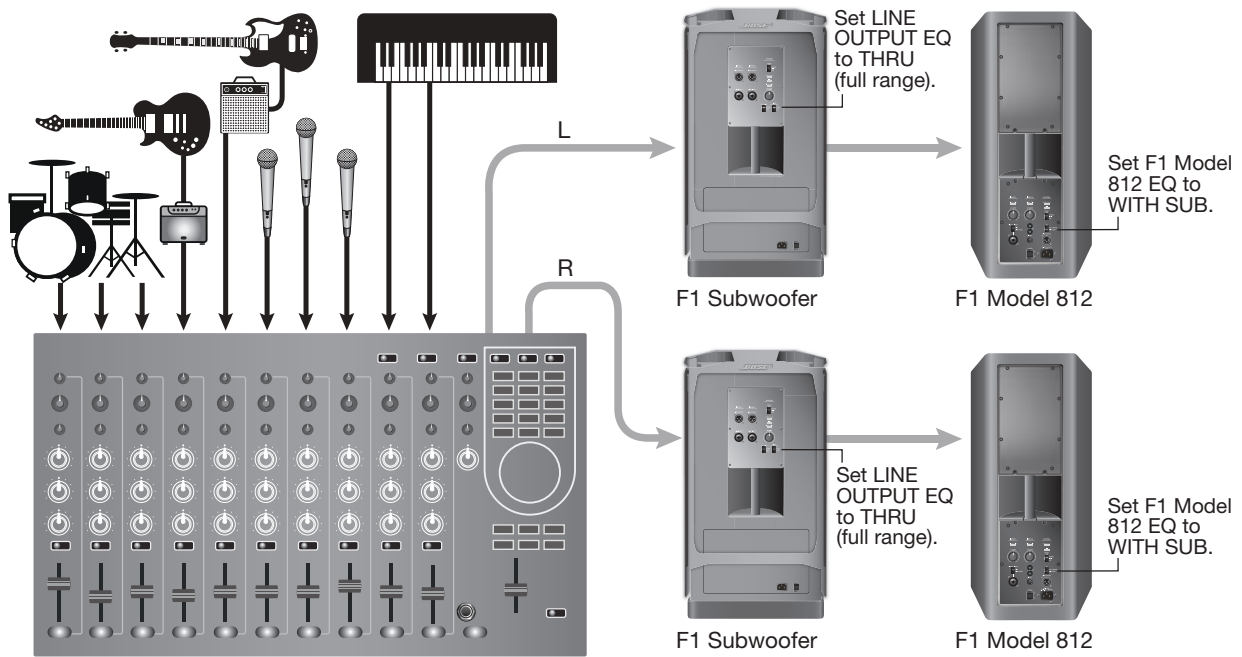

**Stereo input to Left/right F1 Subwoofers and F1 Model 812 Loudspeakers**

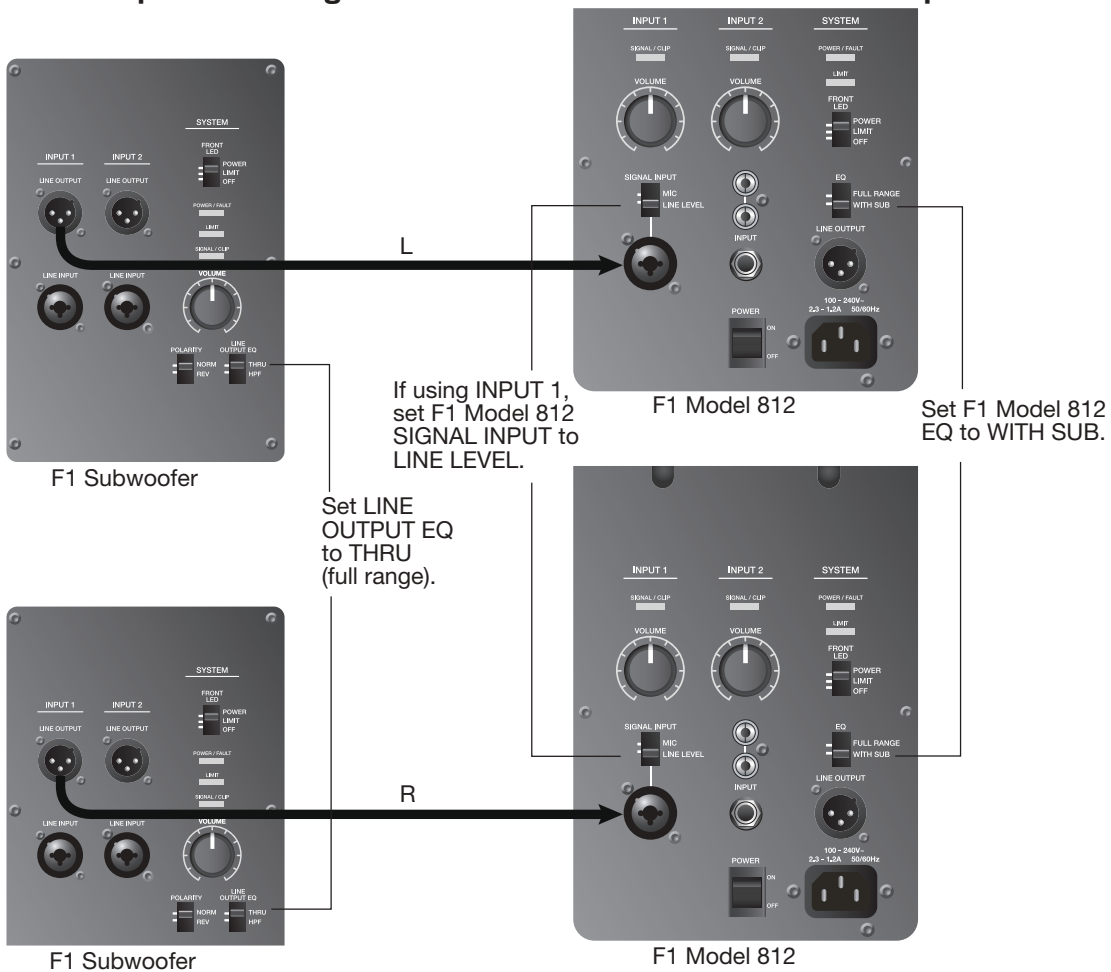

## Mic to F1 Model 812 Loudspeaker INPUT 1

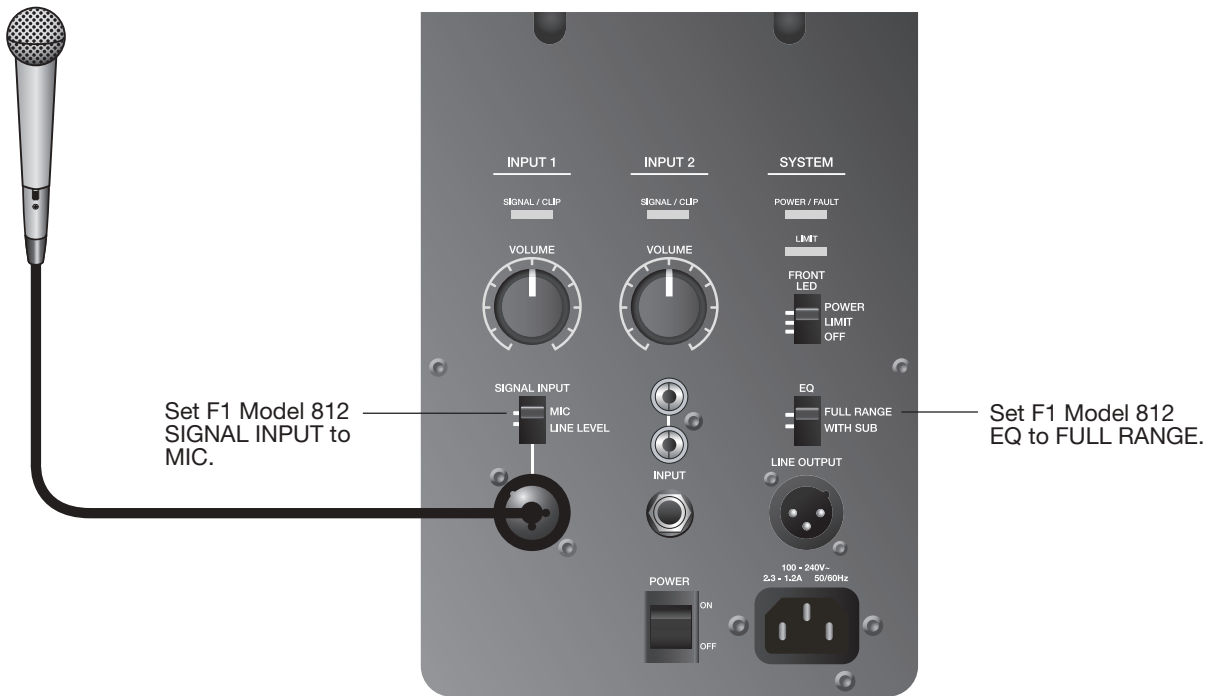

## Mobile device to single F1 Model 812 Loudspeaker

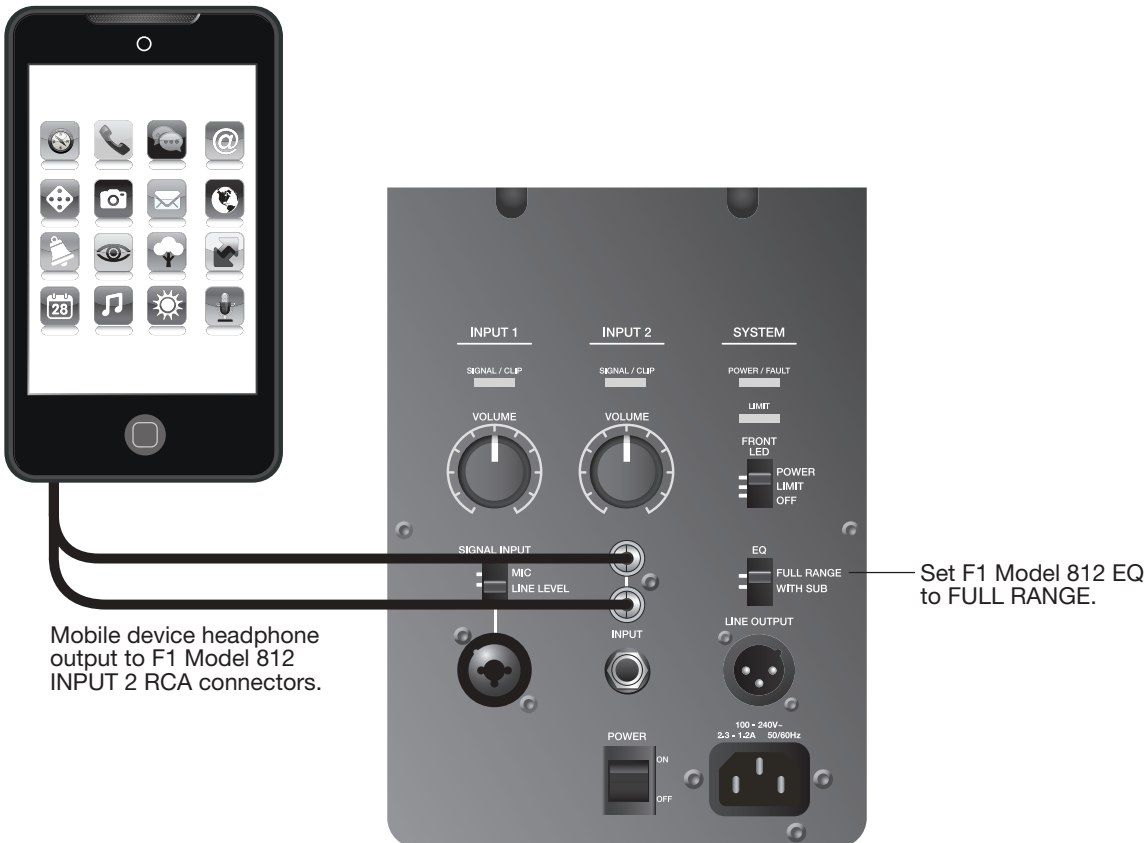



**Mobile device to F1 Flexible Array Loudspeaker system**

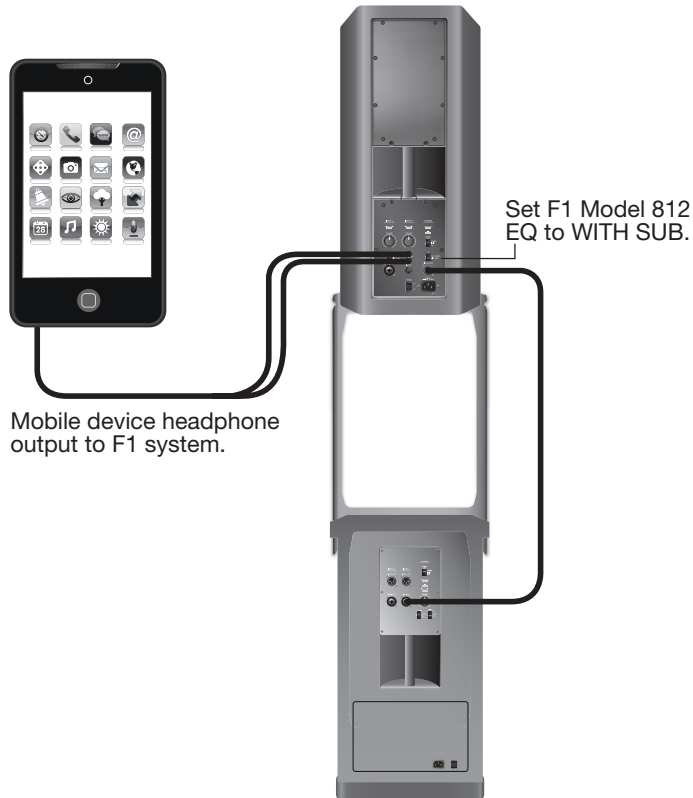

**Mobile device to F1 Model 812 Loudspeaker and F1 Subwoofer**

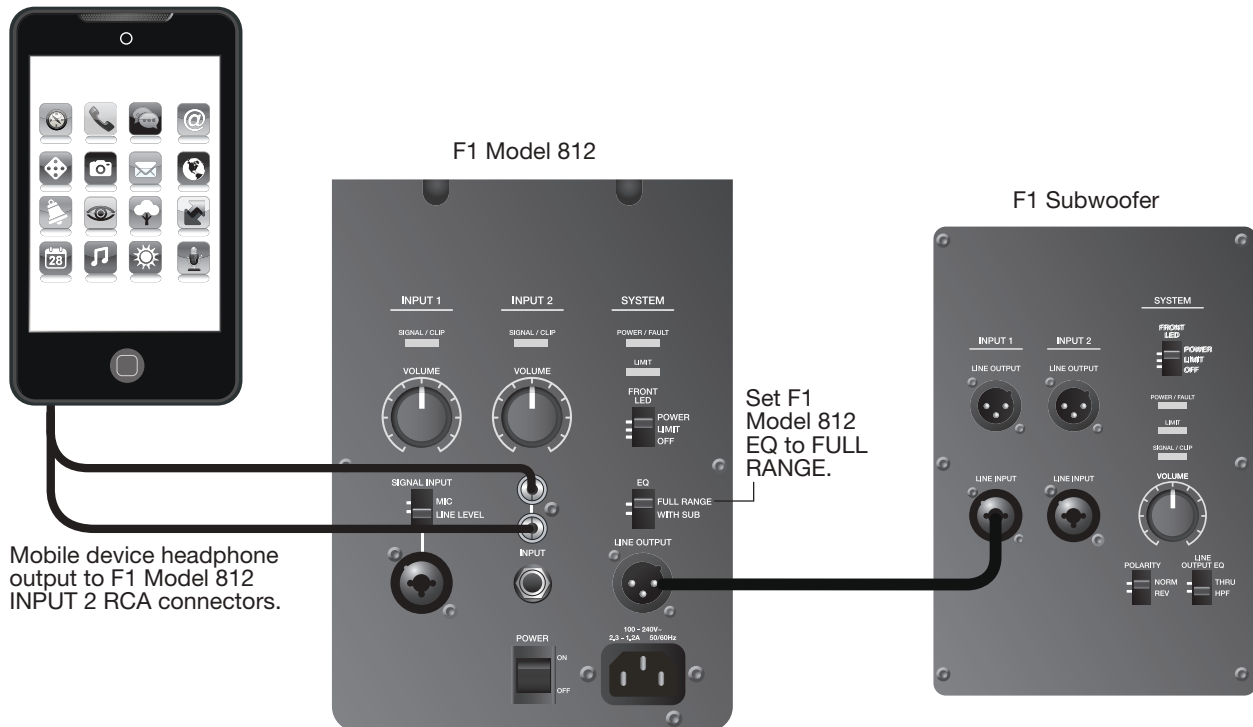

## DJ Console to two F1 Subwoofers and two F1 Model 812 Loudspeakers

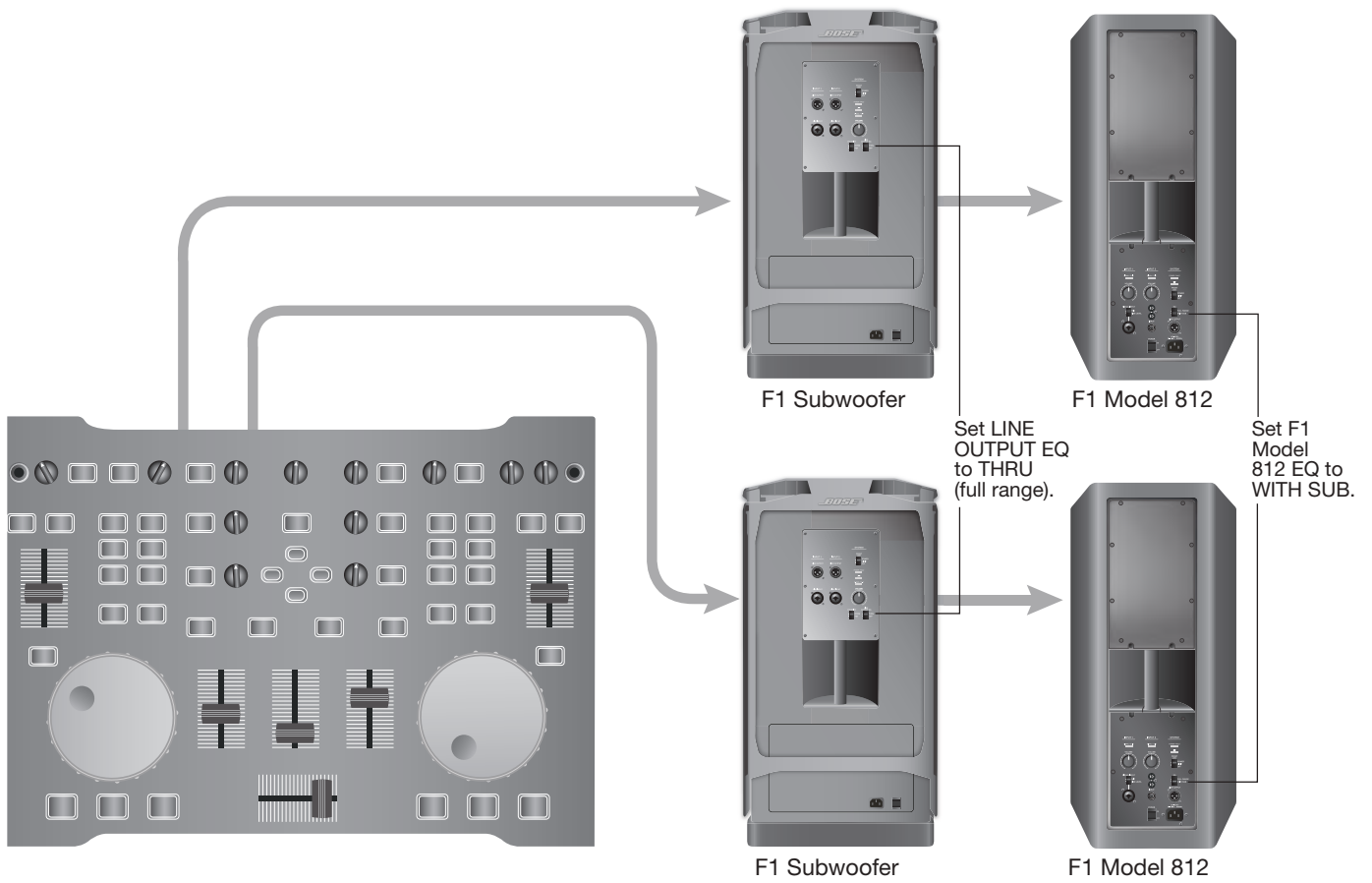

## Caring for Your Product

### Cleaning

- Clean the product enclosures using only a soft, dry cloth.
- Do not use any solvents, chemicals, or cleaning solutions containing alcohol, ammonia, or abrasives.
- Do not use any sprays near the product or allow liquids to spill into any openings.
- If necessary, you may carefully vacuum the grille of the loudspeaker array.

### Getting Service

For additional help in solving problems, contact the Bose Professional Sound Division at (877) 335-2673 or visit our support area online at [www.Bose.com/livesound](http://www.Bose.com/livesound).

## Troubleshooting

If you experience problems while using this product, try the following solutions. The recommended troubleshooting tools include a spare AC power cord and extra XLR and 1/4" phone plug cables.

Problem	What to do
Loudspeaker is plugged in, power switch is on, but power LED is off.	<ul style="list-style-type: none"> <li>• Make sure the power cord is fully engaged into both the F1 Model 812 Loudspeaker and the AC outlet.</li> <li>• Make sure you have power at the AC outlet. Try operating a lamp or other equipment from the same AC outlet.</li> <li>• Try a different power cord.</li> </ul>
Power LED is on (green),but no sound.	<ul style="list-style-type: none"> <li>• Make sure the VOLUME control is turned up.</li> <li>• Make sure volume control is turned up on your instrument.</li> <li>• Make sure your instrument or audio source is plugged into the appropriate input connector.</li> <li>• If the F1 Model 812 Loudspeaker is receiving input from the F1 Subwoofer, make sure the subwoofer is turned on.</li> </ul>
Instrument or audio source sounds distorted.	<ul style="list-style-type: none"> <li>• Lower the volume of the connected audio source.</li> <li>• If you are connected to an external mixing console, make sure input gain to the mixing console input channel is not clipping.</li> <li>• Reduce the output of the mixing console.</li> </ul>
Microphone is encountering feedback.	<ul style="list-style-type: none"> <li>• Reduce the input gain on the mixing console.</li> <li>• Try positioning the microphone so it nearly touches your lips.</li> <li>• Try a different microphone.</li> <li>• Use the tone controls on the mixing console to reduce the offending frequencies.</li> <li>• Increase the distance from the loudspeaker to the microphone.</li> <li>• If using a vocal effects processor, make sure it is not contributing to the feedback.</li> </ul>
Poor Bass Response	<ul style="list-style-type: none"> <li>• If using the F1 Model 812 Loudspeaker without the F1 Subwoofer, make sure the EQ switch is set to FULL RANGE.</li> <li>• If using the F1 Model 812 Loudspeaker with the F1 Subwoofer, check to see if the POLARITY switch is in NORMAL mode. If there is a fair amount distance between the F1 Subwoofer and the F1 Model 812 Loudspeaker, setting the POLARITY switch to REV may improve bass.</li> <li>• If using two F1 Subwoofers, make sure that the POLARITY switch is in the same position on each subwoofer.</li> </ul>

## Care and Maintenance

Problem	What to do
Excessive Noise or System Hum	<ul style="list-style-type: none"> <li>• When connecting a microphone to the F1 Model 812 Loudspeaker, make sure the INPUT 1, SIGNAL INPUT switch is set to MIC.</li> <li>• Check to make sure that all system connections are secure. Lines that are not completely connected could create noise.</li> <li>• If using a mixing console, external source or receiving input from the F1 Subwoofer, make sure the INPUT 1 SIGNAL INPUT switch on the F1 Model 812 Loudspeaker is set to LINE.</li> <li>• For best results, use balanced (XLR) connections on the system inputs.</li> <li>• Keep all signal-carrying cables away from AC power cords.</li> <li>• Light dimmers can cause hum in loudspeaker systems. To avoid this, plug the system into a circuit that is not controlling lights or dimmer packs.</li> <li>• Plug the audio system components into power outlets that share a common ground.</li> <li>• Check cables at mixing console inputs by muting channels. If the hum goes away, replace the cable at that mixing console channel.</li> </ul>

## LED Indicators

The following table describes LED behavior on both the F1 Model 812 Loudspeaker and F1 Subwoofer.

Type	Location	Color	Behavior	Indication	Required Action
Front LED (Power)	Front Grille	Blue	Steady state	Loudspeaker is on	None
		Blue	Pulsing	Limiter is active, amplifier protection engaged	Reduce volume or source input level
SIGNAL/CLIP	INPUT 1/2	Green (nominal)	Flicker/Steady state	Input signal present	Adjust to desired level
		Red	Flicker/Steady state	Input signal too high	Reduce volume or source input level
POWER/FAULT	Rear panel	Blue	Steady state	Loudspeaker is on	None
		Red	Steady state	Amplifier thermal shutdown active	Turn loudspeaker off
LIMIT	Rear panel	Amber	Pulsing/Steady state	Limiter is active, amplifier protection engaged	Reduce volume or source input level

## Limited Warranty and Registration

Your product is covered by a limited warranty. Visit [pro.bose.com](http://pro.bose.com) for warranty details.

Register your products online at [www.bose.com/register](http://www.bose.com/register) or call (877) 335-2673. Failure to do so will not affect your warranty rights.

## Accessories

A variety of wall/ceiling brackets, carry bags and covers are available for these products. Contact Bose to place an order. See the contact information inside the rear cover of this guide.

## Technical Information

### Physical

	Dimensions	Weight
F1 Model 812 Loudspeaker	26.1" H x 13.1" W x 14.6" D (665 mm H x 334 mm W x 373 mm D)	44.5 lb (20.18 Kg)
F1 Subwoofer	27.0" H x 16.1" W x 17.6" D (688 mm H x 410 mm W x 449 mm D)	55.0 lb (24.95 Kg)
F1 system stack	73.5" H x 16.1" W x 17.6" D (1868 mm H x 410 mm W x 449 mm D)	99.5 lb (45.13 Kg)

### Electrical

	AC power rating	Peak inrush current
F1 Model 812 Loudspeaker	100–240V $\sim$ 2.3–1.2A 50/60Hz	120 V RMS: 6.3A RMS 23 V RMS: 4.6A RMS
F1 Subwoofer	100–240V $\sim$ 2.3–1.2A 50/60Hz	120 V RMS: 6.3A RMS 23 V RMS: 4.6A RMS

### Input/Output Connector Wiring Reference

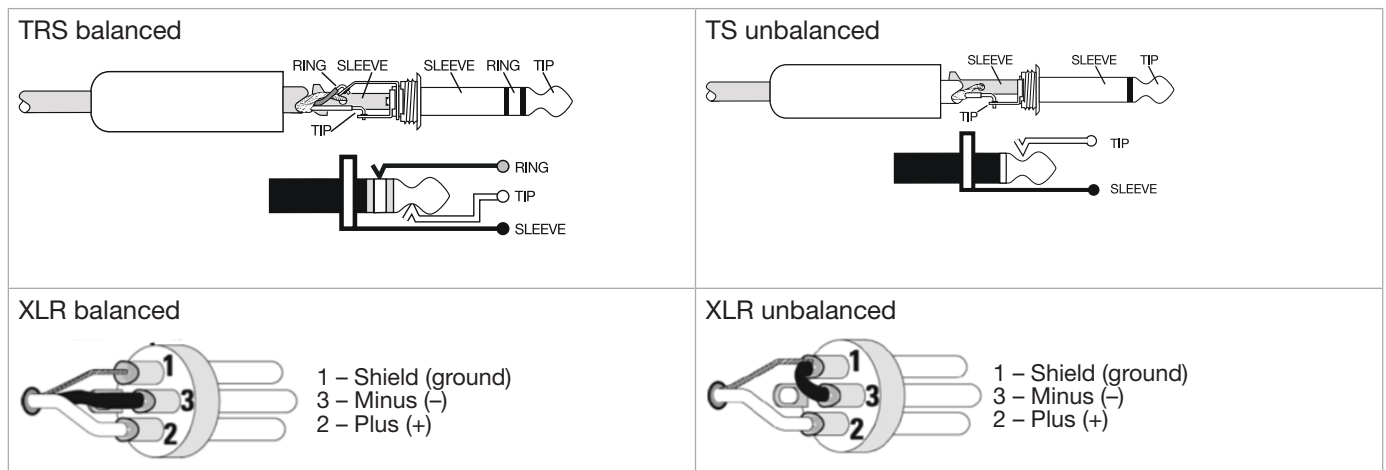

Visit us on the web at [pro.Bose.com](http://pro.Bose.com).

### **Americas**

(USA, Canada, Mexico, Central America, South America)  
Bose Corporation  
The Mountain  
Framingham, MA 01701 USA  
Corporate Center: 508-879-7330  
Americas Professional Systems,  
Technical Support: 800-994-2673

### **Australia**

Bose Pty Limited  
Unit 3/2 Holker Street  
Newington NSW Australia  
61 2 8737 9999

### **Belgium**

Bose N.V. / S.A  
Limesweg 2, 03700  
Tongeren, Belgium  
012-390800

### **China**

Bose Electronics (Shanghai) Co Ltd  
25F, L'Avenue  
99 Xianxia Road  
Shanghai, P.R.C. 200051 China  
86 21 6010 3800

### **France**

Bose S.A.S  
12 rue de Temara  
78100 St. Germain en Laye, France  
01-30-61-63-63

### **Germany**

Bose GmbH  
Max-Planck Strasse 36D 61381  
Friedrichsdorf, Deutschland  
06172-7104-0

### **Hong Kong**

Bose Limited  
Suites 2101-2105, Tower One, Times Square  
1 Matheson Street, Causeway Bay, Hong Kong  
852 2123 9000

### **India**

Bose Corporation India Private Limited  
Salcon Aurum, 3rd Floor  
Plot No. 4, Jasola District Centre  
New Delhi – 110025, India  
91 11 43080200

### **Italy**

Bose SpA  
Centro Leoni A – Via G. Spadolini  
5 20122 Milano, Italy  
39-02-36704500

### **Japan**

Bose Kabushiki Kaisha  
Sumitomo Fudosan Shibuya Garden Tower 5F  
16-17, Nanpeidai-cho  
Shibuya-Ku, Tokyo, 150-0036, Japan  
TEL 81-3-5489-0955  
[www.bose.co.jp](http://www.bose.co.jp)

### **The Netherlands**

Bose BV  
Nijverheidstraat 8 1135 GE  
Edam, Nederland  
0299-390139

### **United Kingdom**

Bose Ltd  
1 Ambley Green, Gillingham Business Park  
KENT ME8 0NJ  
Gillingham, England  
0870-741-4500

**See website for other countries**



740644-0010

***BOSE***<sup>®</sup>  
*Better sound through research*<sup>®</sup>

©2015 Bose Corporation, The Mountain,  
Framingham, MA 01701-9168 USA  
AM740644 Rev. 00