

TEC-X 1000

Wall Control Panel

Installation & Operation Guide

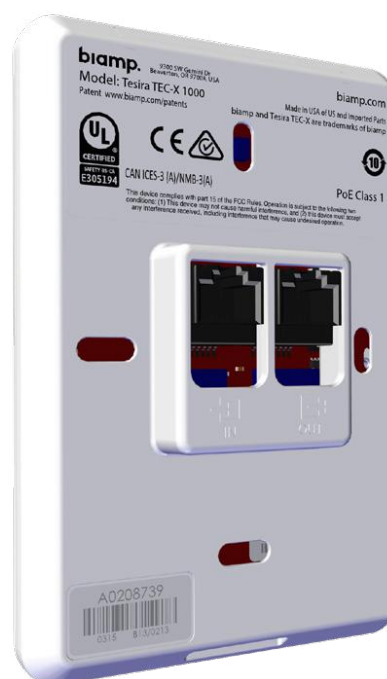

PRODUCT DESCRIPTION

The Biamp TEC-X 1000 Wall Control Panel is a wall-mounted control device used to manage certain functions of Tesira systems via a customizable touch panel and rotary knob. Button knob functions may be configured to control presets and a multitude of logic functions. The TEC-X 1000 is powered by PoE and is easily mounted to a variety of electrical junction boxes. An optional tabletop mount is also available.



FEATURES

- Customizable LCD touchscreen
- Customizable LED light-bar
- PoE powered
- Daisy-chain up to four devices
- Rotary knob for level control and action
- Ambient light sensor (automatically adjusts LCD and LED)
- CE marked, UL listed and RoHS compliant

SETUP AND USE

The Tesira software provides an intuitive interface for setup and programming of the TEC-X 1000. The information supplied by this manual relates to physical connections and device setup. For more details on software setup, including programming the functions of the rotary knob, please consult the [Tesira Help File](#).

The TEC-X 1000 Wall Control Panel is designed to be mounted directly to a 4" X 2" electrical junction box per room design requirements (each remote requires its own box). An optional tabletop mount is also available. Up to four TEC-X 1000 panels may be installed in daisy-chain. Installation hardware is included. Detailed installation instructions are on the following pages.

Once installed in the appropriate location, all further set-up and configuration is done via Tesira software.

IMPORTANT SAFETY / COMPLIANCE INFO

Install the TEC-X 1000 Wall Control Panel away from heat sources, such as vents, radiators and heat registers. Also avoid installing near water or appliances that may produce steam or other forms of moisture. Do not exceed the maximum ambient operating temperature of 32°–95°F (0°–35°C).

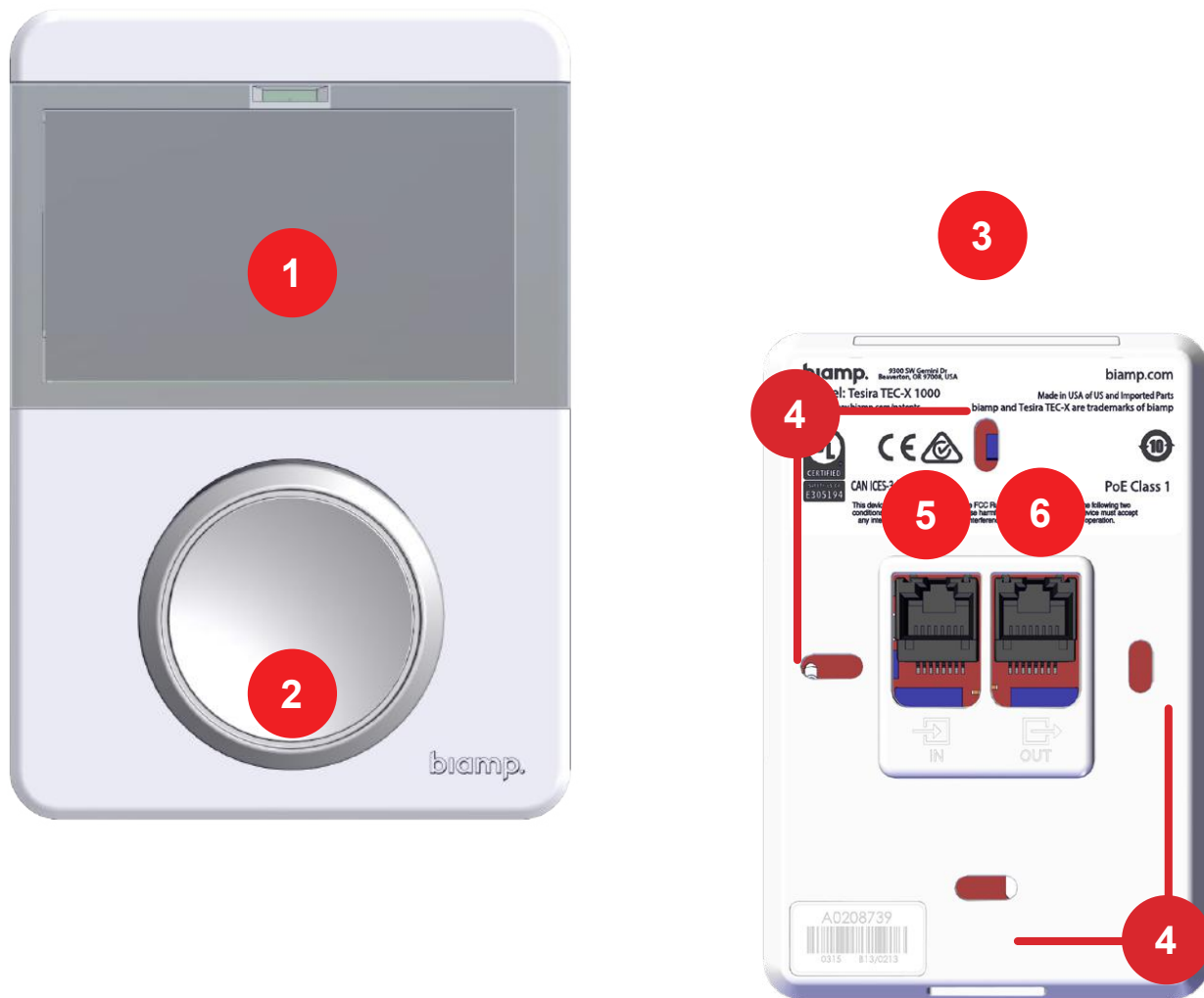

Figure 1. Front and Back of
TEC-X 1000 Wall Control Panel

TEC-X 1000 Wall Control Panel

1. Capacitive-Touch LCD Display
2. Rotary Knob
3. LED Light Bar
4. Mounting Holes (4 Places)
5. Ethernet In (From Control Network)
6. Ethernet Out (Daisy Chain to TEC-X Devices)

INSTALLATION

The TEC-X 1000 is designed to be installed into a standard 'gang' box outlet and may be be daisy-chained with up to four additional TEC-X devices.

NOTE: All Ethernet cabling should be connected prior to installation.

Mount the TEC-X 1000 to a junction back box outlet as follows:

The TEC-X 1000 comes 'partially' assembled with a pull tab installed over the lower clip. This allows easier separation of the face and back plates to prevent damage.

1. See Figure 2. Pull down and out on the face plate to separate it from the back plate and remove the pull tab.

NOTE: Do not snap the face plate onto the back plate until all finish work is done to the wall surface and the Ethernet cables have been connected.



Figure 2. Separate face plate from back plate.

INSTALLATION (CONTINUED)

2. See Figure 3. Insert the control Ethernet cable through the port labeled "IN".
3. See Insert the downstream Ethernet cable through the port labeled "OUT" as required.



Figure 3. Insert Ethernet Cables

4. See Figure 4. Install screws through the back plate into the gang-box.

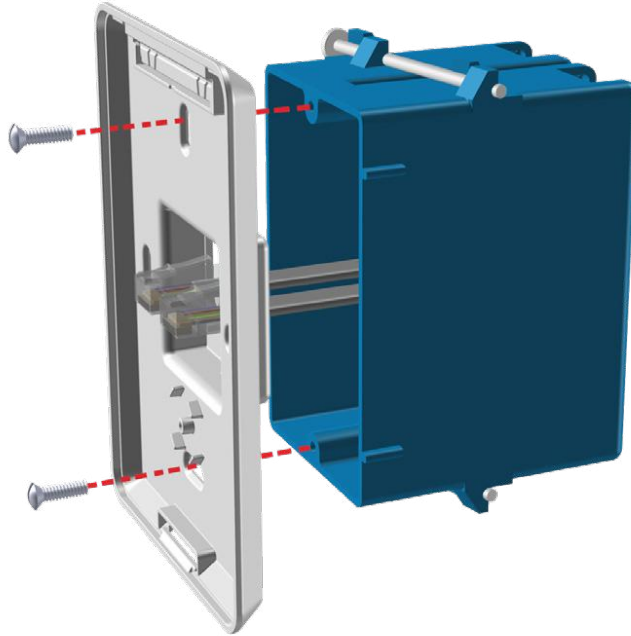

Figure 4. Back Plate Installation

5. See Figure 5. Insert the Ethernet cables into the appropriate ports on the face panel.

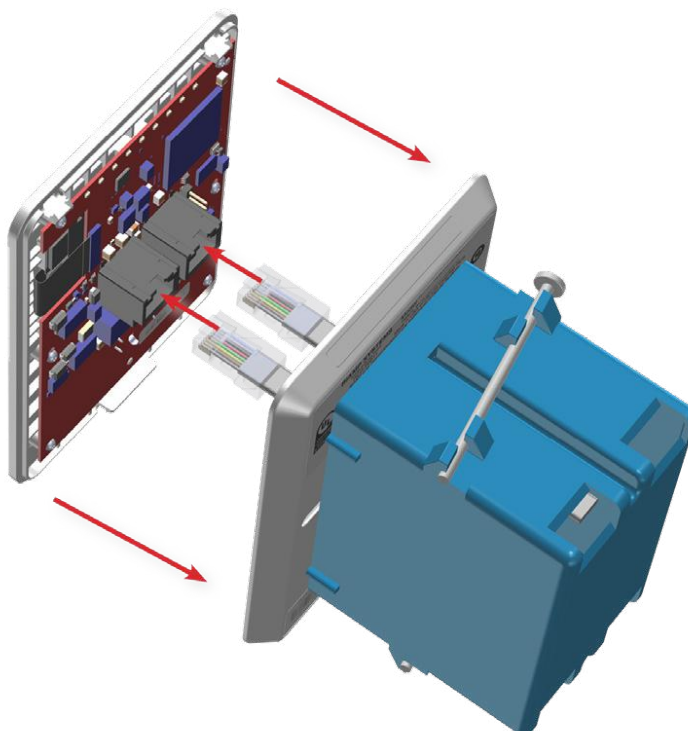

Figure 5. Connect Ethernet Cables

INSTALLATION (CONTINUED)

6. Carefully clip the face plate into place over the installed back plate.
 - a. See Figure 6. Align the upper clips into the two receptacles at the top of the back plate.
 - b. Snap the lower clip into the receptacle on the back plate.
7. Up to four TEC-X 1000 or 2000 devices may be daisy-chained together in any combination (four devices total). The maximum distance allowed between devices in a daisy chain is 100 meters (maximum of 400 meters overall).

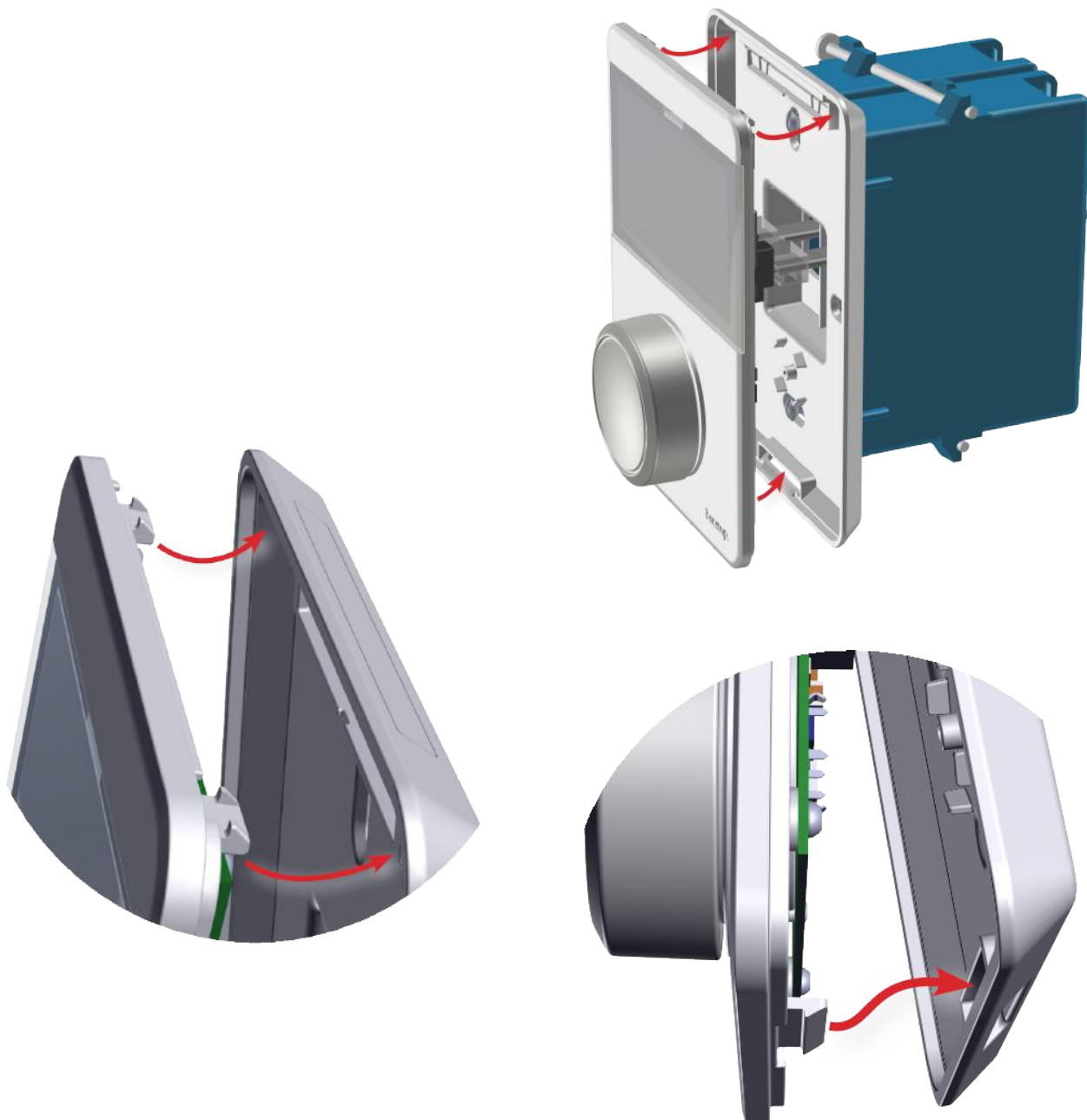

Figure 6. Clip Installation

TABLE-MOUNT INSTALLATION (OPTIONAL)

The table-mount may only be used with the last device of a daisy chain. For face plate removal see [Maintenance](#).

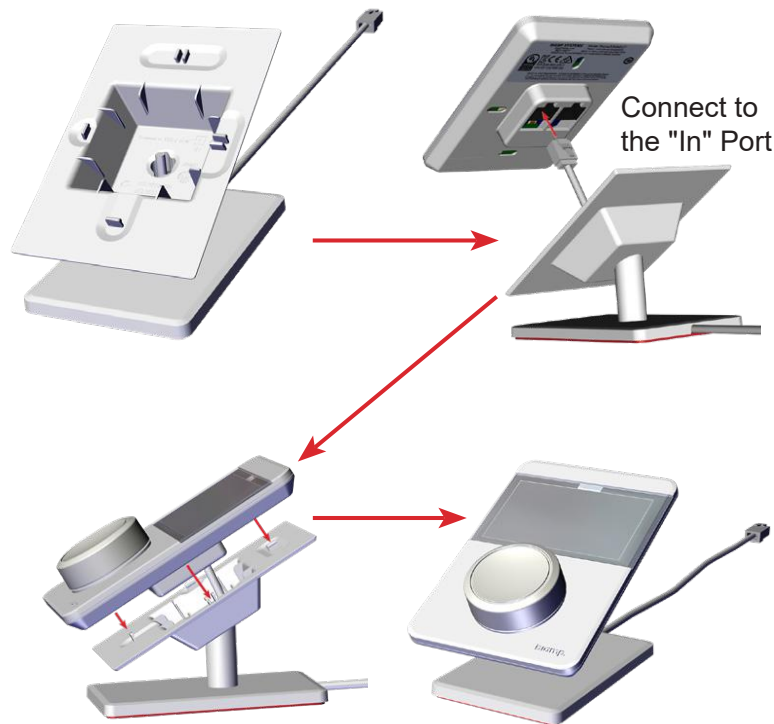

Figure 7. Table Mount Installation

WIRING

The TEC-X 1000 must be connected to a Tesira Server-Class device (such as a TesiraFORTE). Up to 4 TEC-X 1000 devices may be connected in daisy-chain. TEC-X 2000s may be included in such a daisy-chain, as long as there are only a total of 4 TEC-X devices connected. Figure 9 is a basic layout with a TesiraFORTE and 4 TEC-X 1000 wall control devices.

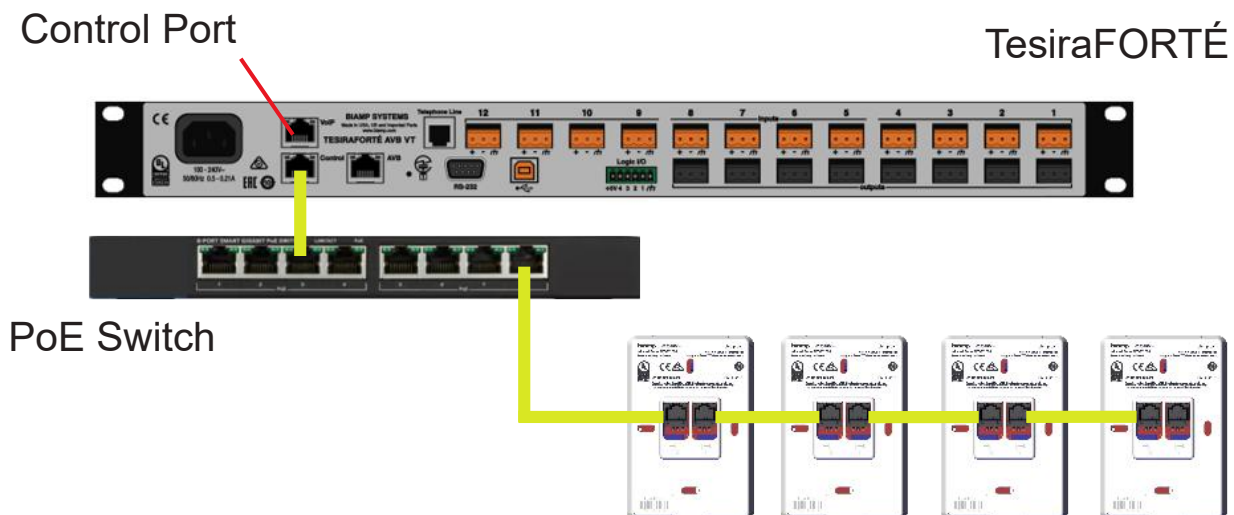

Figure 8. Basic Network Layout



OPERATION

Operation of the TEC-X 1000 varies depending on how the device is configured in Tesira. The following section gives basic information on the rotary dial and touchscreen configurations.

1. Once all connections are made and devices powered on, the TEC-X can be configured to initiate a variety of actions and presets as configured in Tesira, such as:
 - Lock/Unlock a remote
 - Select audio source
 - Adjust audio levels
 - Recall presets
 - Mute signal
 - Combine/Divide rooms (Room Combiner)
 - Send commands to a 3rd party device
2. Upon initial startup after configuration in Tesira software, the TEC-X will display a splash-screen and information about the device (firmware version, MAC address, etc.). Once initialized, the control functions will be available.

NOTE: Tesira programmers have the option of locking the device so that a PIN code will be required to access functions.

3. The buttons and rotary knob may be configured in the [Tesira software](#). The interface may be customized to match the physical device.
4. The Tesira software allows for multiple pages each with unique icons, text, button color, etc. Figures 8 and 9 show examples of color and layout.
5. The rotary knob has a dètente feel and may be programmed as an additional button for initiating a logic function, preset, etc. The rotary knob may be programmed to control changes in value (such as volume).

6. The display also gives the following information:
- A padlock icon indicates the device is locked and requires a pin to access functions 
 - Device is in Locate Mode 
 - Faults is displayed with text indicating the fault 
7. The screen will auto-dim and sleep (go blank) after a period of time determined in Tesira SW.

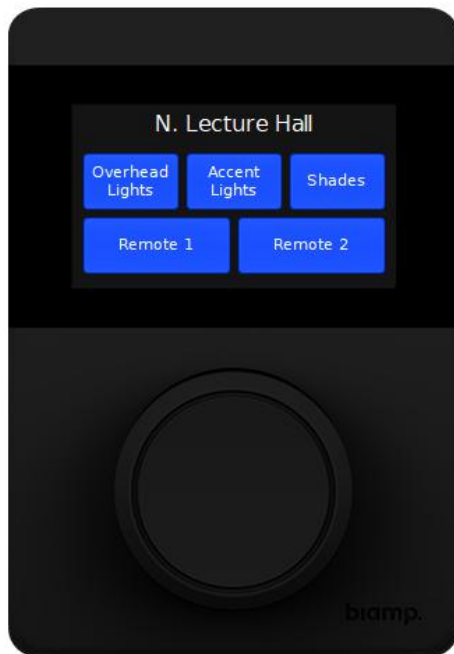

Figure 9. Five-Button Layout

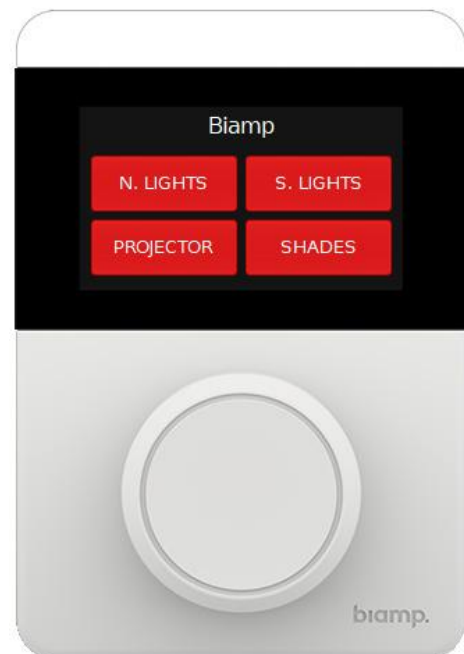

Figure 10. Four-Button Layout

MAINTENANCE



Important: Do not snap the face plate onto the back plate until all finish work is done to the wall surfaces and the Ethernet cables have been connected. The face plate can be removed by inserting a flat screwdriver into the slot at the bottom of the back plate, carefully depressing the tab and pulling the face plate out and down. The tab is stiff and care should be taken to not damage the plastic.

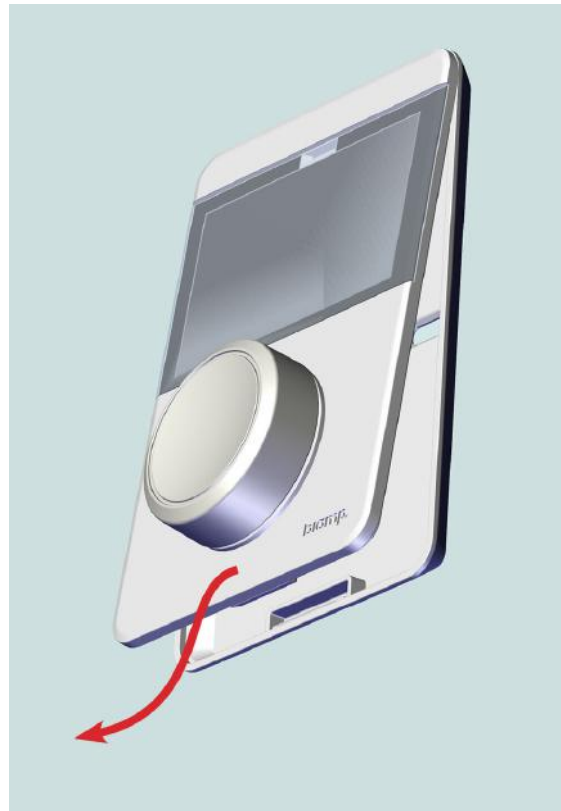
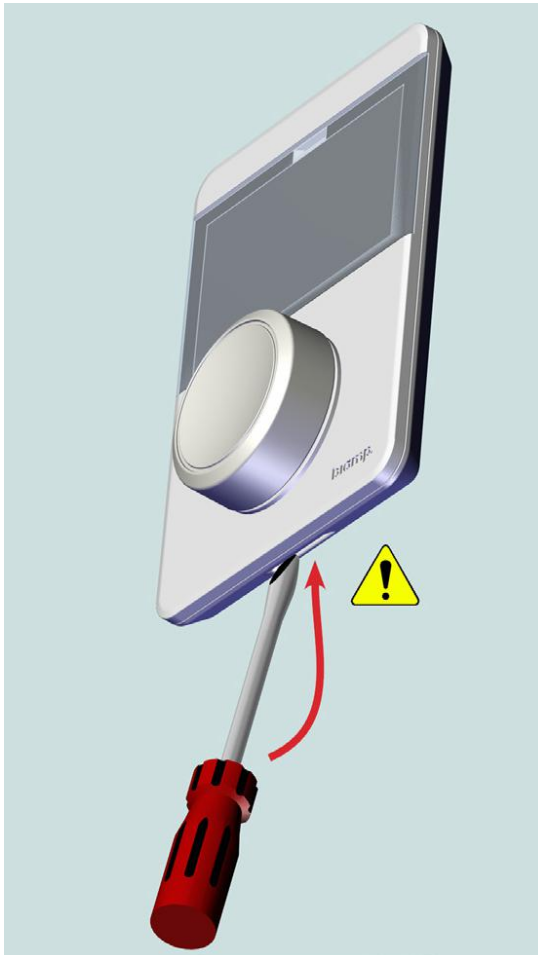

Figure 11. Remove Face Plate



CONTACT US

Email

support@biamp.com

Web

support.biamp.com

Safety and Compliance

www.biamp.com/compliance

Warranty

www.biamp.com/legal/warranty-information

Note: Every effort has been made to ensure that the information contained in this manual was complete and accurate at the time of printing. However, due to ongoing technical advances, changes or modifications may have occurred that are not covered in this manual. The latest version is available at www.biamp.com.