

Tango
Touch panel controller

INSTALLATION CONSIDERATIONS

- The Tango controls room AV systems using connected Biamp touch panel displays and keypads as the user interface devices.
- The controller can be mounted freestanding on desktops, secured to a flat surface such as a table bottom, or in a 19-inch AV equipment rack using a Biamp rack shelf.
- PoE powered: Use a compliant PoE power supply or switch. PoE injector not included.
- An infrared learner sensor is located on the front panel (IR).
- The controller and AV system devices are configured using Biamp’s Project Designer utility software.

INCLUDED IN THE BOX

- Tango touch pad controller
- 11 Terminal connectors
- 2 wall-mount screws and 2 drywall anchors O4x60 mm
- 2 rack-shelf mounting screws M4x35 mm
- 4 Adhesive feet



Device Layout

Front Panel Layout and Descriptions

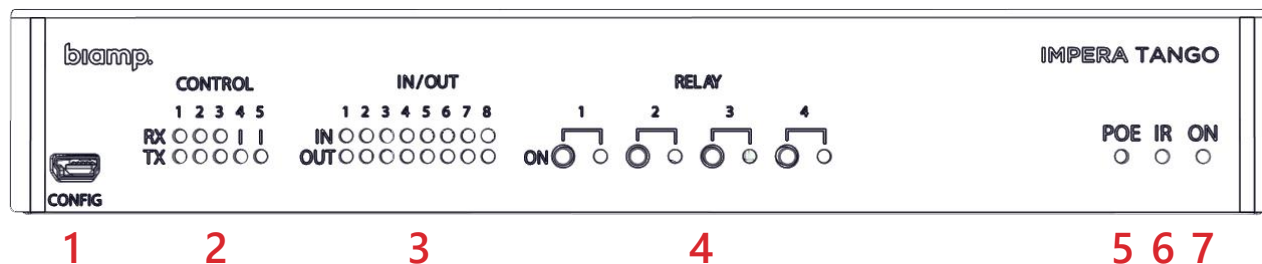

1. Mini USB-B 5P configuration port
2. RS-232 control status indicators
3. General purpose input / output indicators
4. Paired relay test buttons and indicators
5. PoE output status indicator
6. IR Learner input sensor
7. Power on status and error indicator

Configuration USB Port

The mini-B USB port is used to upload configuration files to the Tango controller.

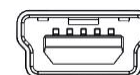

CONFIG

Control Indicators

These RS-232 / IR transmitter LED status indicators illuminate when there are active communications on the controller's RS-232 and IR terminals.

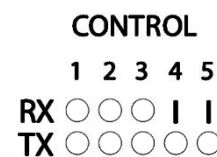

General Purpose Input / Output Indicators

These input and output indicators illuminate when a high signal is present on the corresponding ports.

- Input high signal light yellow
- Output high signal light green

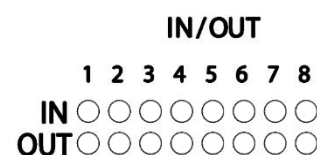

The indicator is dark when a low signal is present on the corresponding port.

Relay Buttons and Indicators

The 4 relay buttons test the functionality of devices connected to the back panel relay terminals. During operation, the indicators illuminate when the controller is controlling devices connected to the corresponding relay terminals.

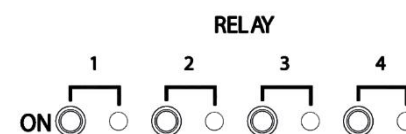

Caution: Multiple relays can be activated at the same time, potentially damaging connected equipment.

PoE Output Status Indicator States (POE)

- Continually on – A compatible PoE device is connected to the PoE output.
- Flashing slow – No PoE enabled device connected.
- Flashing fast – Error or overload on a connected PoE device



IR Learner Function Sensor Lens (IR)

The IR Learner sensor captures infrared control codes from remote control devices while using Biamp's Device Editor utility.

- Captures sequences in the 20 to 60 kHz range.

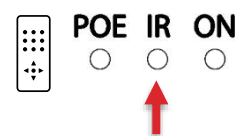

On light Indications (ON)

- Blue – The controller is starting up
- Green – The controller is powered and running normally
- Flashing red – Error mode



Rear Panel Layout

Details on connection point functionality and wiring configurations can be found in the Connect the Controller procedure starting on page 8.

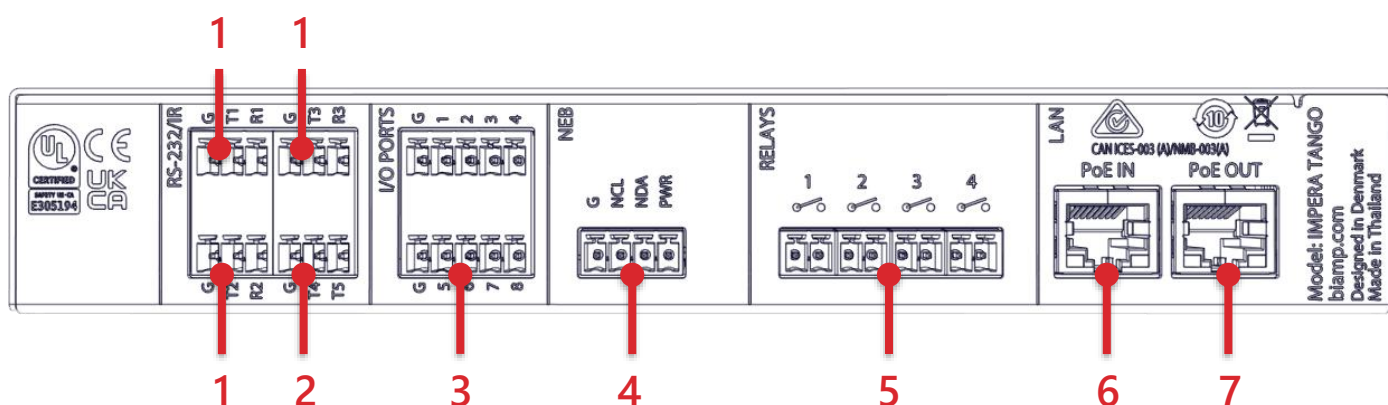

Connections

1. 3 bidirectional RS232 or IR terminals
2. 2 unidirectional RS232 or IR transmit terminals
3. 8 digital general input-output ports
4. Native Expansion Bus (NEB)
5. 4 potential-free relays
6. RJ-45 LAN connector with PoE input (LAN)
7. RJ-45 Lan connector with PoE output (LAN)

Installation and Setup Overviews

Perform the procedures listed in this section to install and set up the controller.

Installation

These procedures and options are described in the Installation section of this guide.

- ✓ **Place or secure the controller in its installation location**, page 7
 - Option 1: Freestanding on a horizontal surface
 - Option 2: Secured to a flat surface
 - Option 3: In a standard 19-inch AV equipment rack
 - Required rack shelf sold separately

- ✓ **Connect the controller**
 - Connect the AV system devices to the controller, page 8
 - Do not connect to a PoE source at this time
 - Connect a compliant PoE source to the PoE IN port, page 12

Continued on next page

Setup

These procedures and options are described in the Setup section of this guide.

- ✓ **Download Biamp's Project Designer software**, page 15
 - This utility is used to configure connected devices, including the graphic user interfaces of connected display panels.

- ✓ **Configure the system and devices**, page 16

- ✓ **(Optional) download Biamp's Device Editor utility**, page 18
 - This software is required to use the Tango's IR learner function for incorporating remote control devices with infrared transmitters.

Installation

Install the Controller

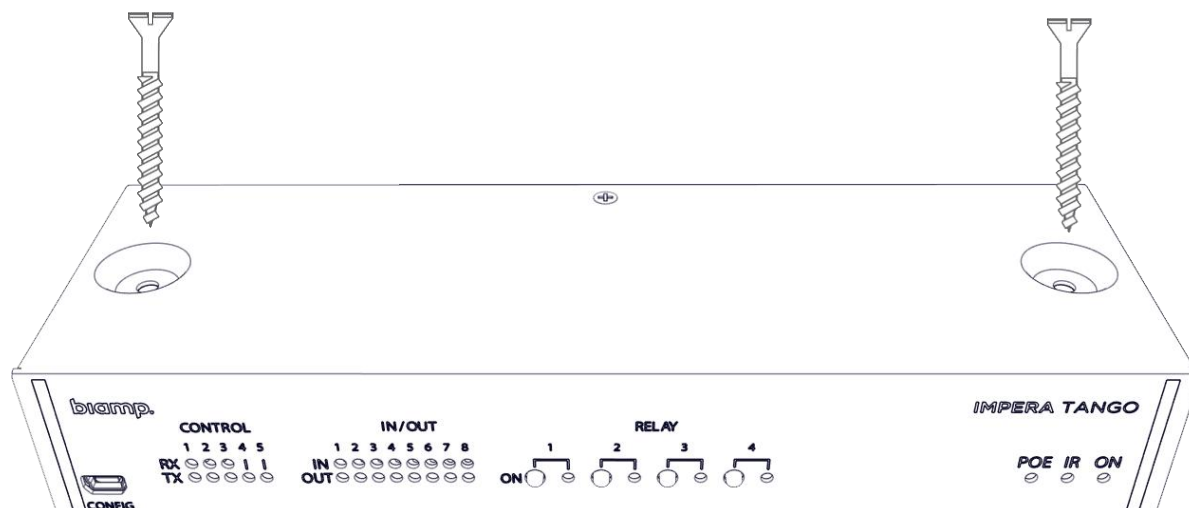

Options

Freestanding on a Flat Surface

1. Mount the 4 included adhesive feet on the bottom of the controller.
2. Place the unit on a desk or other flat, horizontal top surface.

Secured to a Flat Surface

Use the two self-tapping screws included to secure the controller to flat surface.

1. Position and hold the controller on the surface it is to be mounted on.
 - The bottom of the controller must be against the surface, and the screws inserted through the holes on the top of the controller.
2. Fasten the controller in place, screwing both self-tapping screws through the mounting holes into the mounting surface.
 - Use the included anchors for mounting on a drywall surface.

Standard 19-inch Rack (480 mm)

The controller can be mounted in a 19-inch standard AV equipment rack using the included MA4x35mm screws and a Biamp rack shelf PN – 910.0116.900 RMS-1.

Connect the Controller

Connect the controller terminals to the room's AV system devices. Do not connect the PoE IN port or otherwise power up the controller at this time.

- See page 12 for connecting the PoE source or injector to the PoE IN port after the current procedure is complete.

RS-232 and IR Connections

Using Biamp Project Designer software the T and R terminals may be configured as an RS-232 terminal, or the T terminal may be configured as an IR emitter.

Note: If configured as an IR emitter, the R terminal will not be used.

One-Way Communications: The T4 and T5 terminals are dedicated unidirectional transmit terminals.

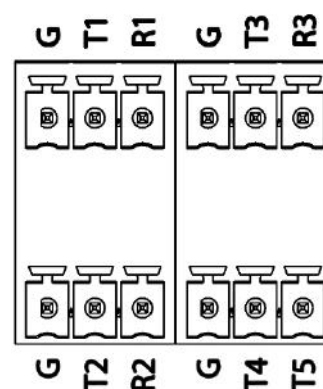

Two-Way Communications: The following terminals can be paired for bidirectional transmit and receive communications. These can be connected to devices requiring a reply function such as projectors.

- T1 + R1
- T2 + R2
- T3 + R3

Connection Figuration Examples

Bidirectional RS232 example

- Pin 5 to G (Ground)
- Pin 3 to T1
- Pin 2 to R1

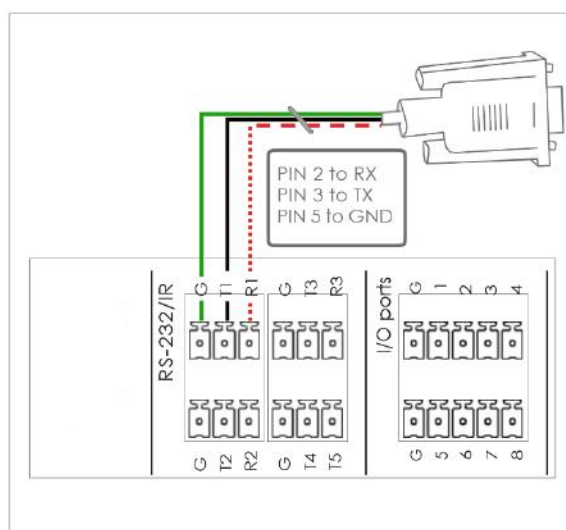

Connections continued

Unidirectional IR transmitter example

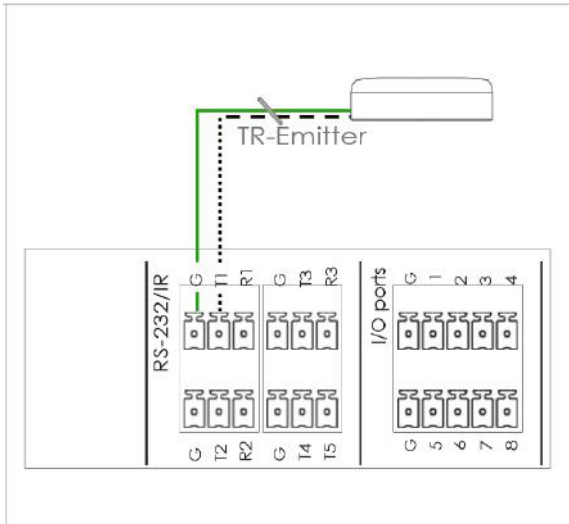

- Emitter to T1
- Ground wire to the paired ground (G)

Dual IR transmitter example

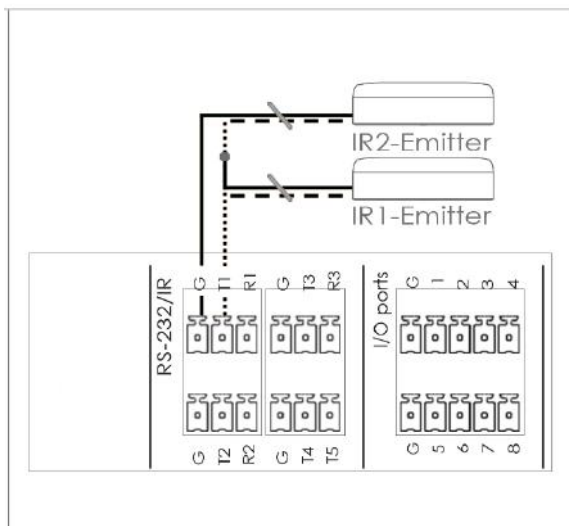

- Connect the IR-1 emitter to T1 with the white-striped wire
- Connect the black wire on the IR-1 emitter to the IR-2 emitter
- Connect the black wire from the IR-2 emitter to paired ground (G)

Connections continued

General Input and Output Ports

The controller has 8 general ports, each of which can be configured as either an output or an input. Each of these I/O ports is available for connection to devices such as a PIR movement sensor, a keyboard lock, relays, or for other compatible uses.

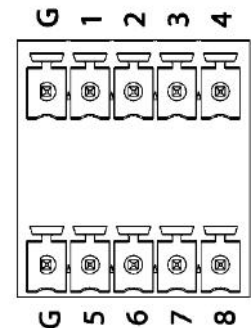

Potential: These ports are not potential-free. External relays may be needed to prevent ground loops depending on the application.

Outputs:

- When used as outputs, the I/O ports are active low.
- When activated, the I/O ports are tied to ground (G) through a FET transistor.
 - Also known as an open drain or collector function.
- Each I/O can draw up to 24VDC/500mA.

Inputs:

- When used as inputs, the applied voltage must be below 1 VDC to be accepted as LOW, and above 4 VDC (but below 24 VDC) to be accepted as HIGH.
- The inputs are default HIGH and must be connected to a ground to change state.

Native Expansion Bus (NEB)

The NEB supports up to 5 expansion bus devices such as keypads, level controls, and expanders.

The NEB port includes an extender allowing up to 131 feet (40m) of separation between the controller and devices connected using the Biamp extender module. The extender module is required for making connections at these distances.

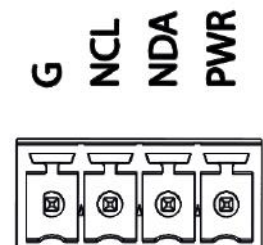

Connections continued

Potential-Free Relays

Default open relays: Each relay is open when off, meaning there is no connection in the off state.

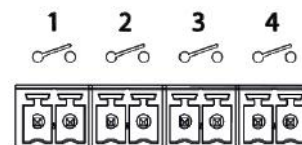

Caution: Multiple relays can be activated at the same time, potentially damaging connected equipment.

LAN PoE OUT

The PoE IN will be connected in the next step.

MDI-X: Both the In and Out PoE ports come with auto MDI-X interfaces. A LAN switch is not required to connect these ports to other devices.

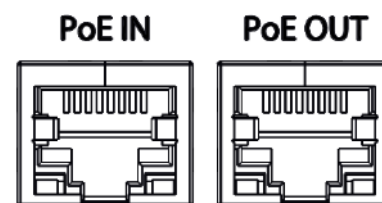

Port LED indicators: Each comes with a yellow LED indicating the link status and a green LED indicating the link speed.

LED Color	Light Off	Light On	Light Blinking
Yellow	No Link	Link	Activity
Green	10 Mbit	100 Mbit	

PoE Out Port

- This port provides power over Ethernet from the Tango controller to a connected PoE-enabled device.
- The connected device must conform to IEEE802.3af

Do not connect the Mini USB 5P

The mini-USB is only used for uploading configuration files to the controller. It cannot be used as a connection point to devices controlled by the controller.

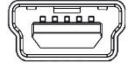

Connect to the Power Over Ethernet Source

The PoE IN connector on the back of the controller provides power over Ethernet to the Tango controller.

Cable: Use an RJ45 terminated LAN cable.

Connection Options:

- Connect to a PoE Injector.
 - The injector must be connected to the PoE IN port in order to enable LAN functionality.
- Connect to a PoE-enabled switch compliant with IEEE2.3af

Note: When switching from USB power to PoE power, the device may reboot. Avoid this issue by keeping the USB power source ungrounded. (e.g., a laptop running on battery power)

Continued on next page

PoE IN connection continued

PoE injector example

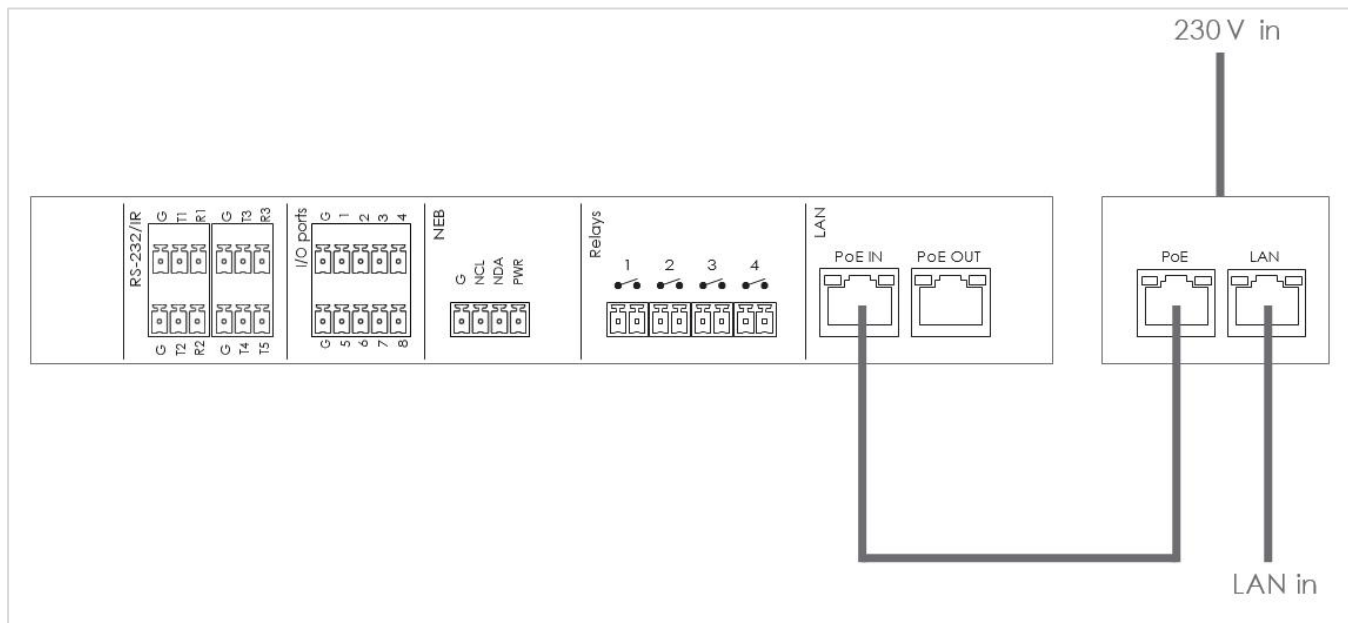

PoE-enabled switch example

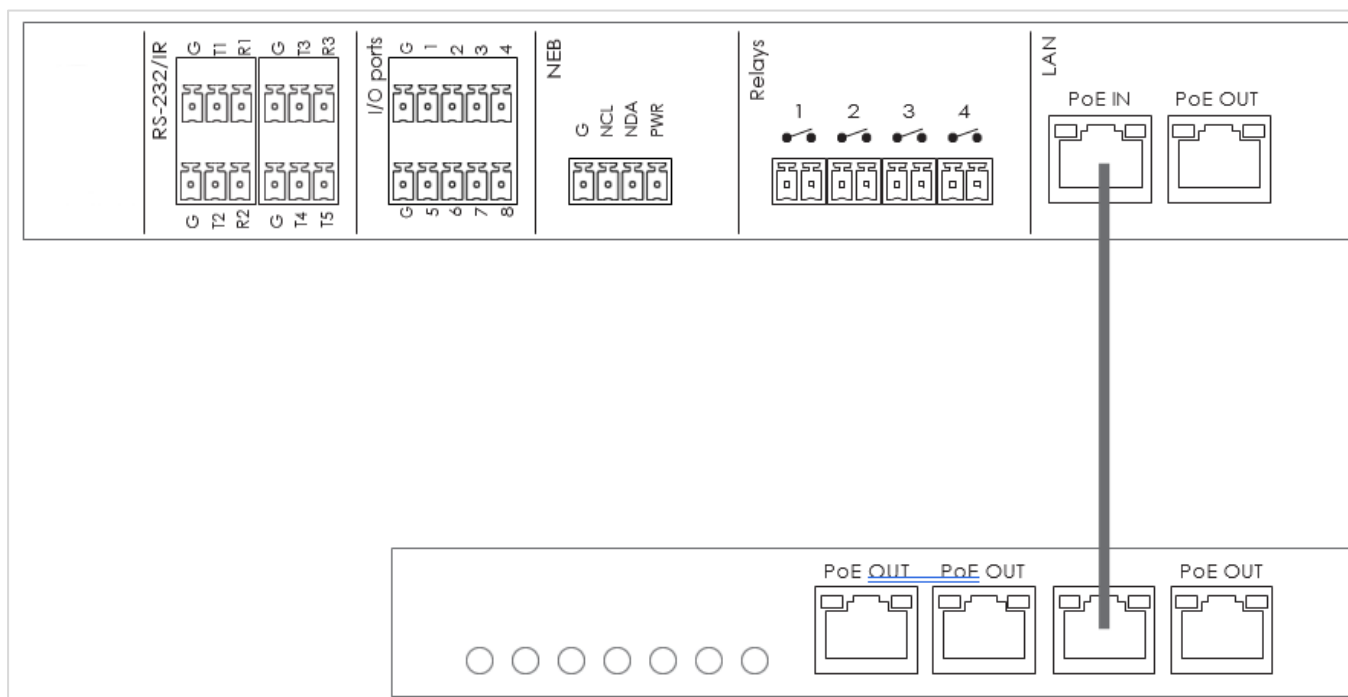

Continued on next page

Power Up Cycle Indicators

When power cycling a factory-configured device the POE, ON, and the 16 IN/OUT LED indicator lights will blink.

Relay Test Functionality

Test the functionality of any devices connected to the relay terminals using the corresponding test buttons on the controller front panel. When the test button is pressed, the LEDs will indicate if the relay is **activated** (green) or **not activated** (off)

Controller Setup

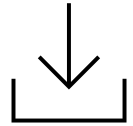

Download Biamp Project Designer Software

The Project Designer utility software provides drag-and-drop functionality for configuring the graphical user interface (GUI) of a connected touch panel or another compatible interface device. Additionally, Designer is used for setting the hardware functions of the Tango controller and those of audio / visual devices attached to the system. See the next page for specifics.

Project Designer also provides the following:

- An extensive driver library for incorporating Biamp and third-party devices in the AV system.
- Automated generation of project documentation.

IR Learner: Download Biamp's Device Editor to use the controller's IR learner function. See page 18. The device may need to be factory reset prior to using IR learning. See page 19.

Download Site

Project Designer can be downloaded from Biamp.com.

- Click here: [Biamp Project Designer](#)

Support Articles

Technical support articles for Project Designer can be found on Biamp's Cornerstone knowledgebase support site.

- Click Here: [Biamp Control - Biamp Cornerstone](#)

Training

An online course covering Optimized Control Design for Impera systems can be registered for on Biamp's training website. This includes how to configure the Impera Tango using Biamp Project Designer software.

- Click here: [Biamp Training - InPerson and Online Training, Certification Courses](#)
 - Look under the "Impera Learning Path" section.

Configure the System

Use the Biamp Project Designer software to configure the controller and the AV system it will control.

1. Configure the controller

- Configure and assign functions to the RS232 / IR and GPIO ports if required.
- Assign any functions required for the expansion bus.
- Set up the relay port functions if required.

2. Configure the connected system user interface device.

Touch Panel Notes: When connected to an Apprimo touch panel, the Tango serves up a web page on the touch screen. The controller uses WebSockets as the interface between the touch panel and itself.

User interface tasks:

- Set up the graphical user interface on the touch panel or control pad.
- Assign functions to any hardware buttons.
- Assign any signal outputs to any LEDs indicators on the interface device.

3. Configure the system and attached audio / visual devices.

Continued on next page

4. Upload the configuration file to the controller.

The configuration file can be uploaded via:

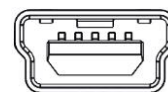

- The controller's Mini USB 5 port
 - The controller can be powered using this port while uploading a configuration file.
 - Uploads can also be safely performed using this port while the controller is connected to a LAN ethernet cable that is supplying power.
- A LAN connection over the PoE IN port

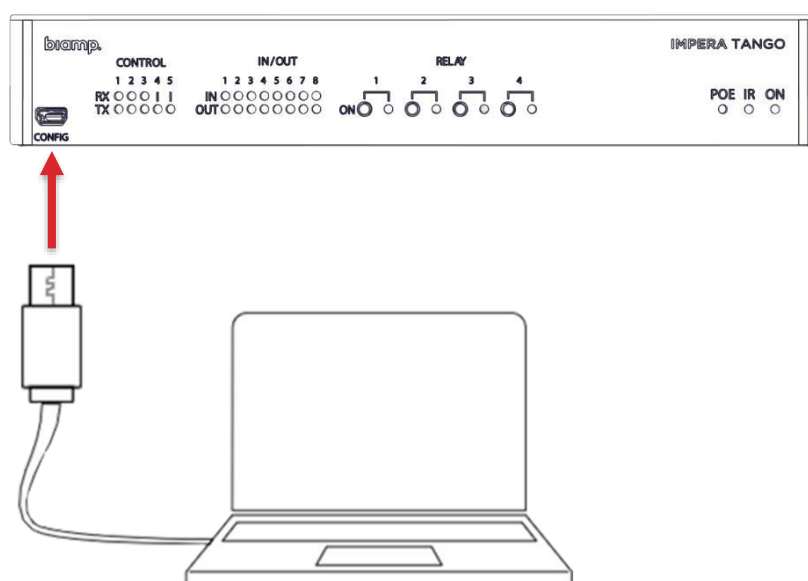

(Optional) Download Biamp's Device Editor Utility

Required to use the IR learner function.

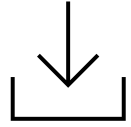

Download Site

The software can be downloaded from Biamp.com.

- Click here: [Downloads \(biamp.com\)](#)

Select:

1. Products: Impera
2. Resource Type: Software/Firmware
 - a. Uncheck the default Datasheets option

Support Articles

Technical support articles for Device Editor can be found on Biamp's Cornerstone knowledgebase support site.

- Click Here: [Getting started with Biamp Device Editor - Biamp Cornerstone](#)

Operations Notes

Restoring to Factory Settings

This deletes the uploaded configuration file and network settings, restoring the controller to its original factory settings. This does not affect the firmware of the controller.

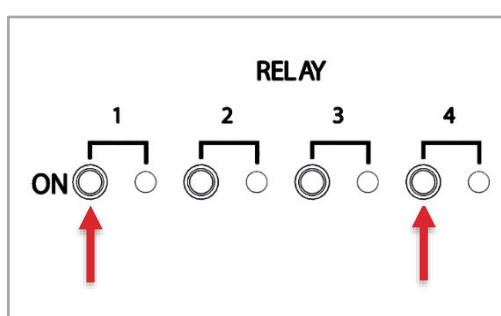

1. Remove all PoE/USB power.
2. Press and hold relay buttons 1 and 4 and apply power.
 - Continue holding the relay buttons until all IN/OUT LED indicators begin flashing.
3. After the reboot completes, LED indicators 1 and 2 will continue flashing. The unit has been reset to its factory settings.

Appendix: LED Error Indicators

The front-panel IN/OUT LED indicators display error codes in the event of an error.

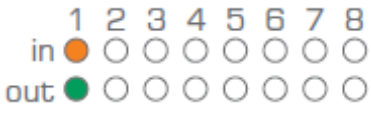
LED Pattern	Error
 <p> 1 2 3 4 5 6 7 8 in ● ○ ○ ○ ○ ○ ○ ○ out ● ○ ○ ○ ○ ○ ○ ○ </p>	<p>No connection to one or more of the native expansion bus ports that have an assigned use in the Project Designer configuration file.</p>
Solutions	
<ul style="list-style-type: none"> • Check that the NEB ports used in the configuration file are configured correctly. • Power cycle: Disconnect the controller from the power source and leave depowered for 20 seconds. Then reconnect and repower. 	

Continued on next page

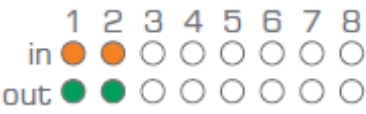
LED Pattern	Error
	<p>No Project Designer configuration file has been found on the controller.</p>
Solutions	
<ul style="list-style-type: none"> • Reload: Attempt to upload the configuration file again. • Verify: If reloading does not solve the problem. there may be a problem in the configuration file. Try uploading an empty project file and check if the error indicator turns off. 	

LED Pattern	Error
	<p>An unknown error has occurred.</p>
Solutions	
<ul style="list-style-type: none"> • Power cycle: Turn off power to the controller for a minimum of 20 seconds. Then repower the controller. 	

LED Pattern	Error
	No contact with the Biamp extension unit.
Solutions	
<ul style="list-style-type: none"> • Verify the extension serial number entered in the Project Designer configuration file matches that of the Biamp extension device. • Connection checks: Check the network or RS-232 connection from the control. system to the extension device. Check the network or RS-232 connection on the Tango and all connected network devices. 	

LED Pattern	Error
	Incompatible firmware version loaded in the Biamp extension device.
Solutions	
<ul style="list-style-type: none"> • Verify the extension serial number entered in the Project Designer configuration file matches that of the Biamp extension device. • Connection checks: Check the network or RS-232 connection from the control. system to the extension unit. Check the network or RS-232 connection on the Tango and all connected network units. 	



www.biamp.com



www.support.biamp.com



Support@biamp.com



9300 SW Gemini Drive Beaverton, OR 978008 USA

Warranty: biamp.com/legal/warranty-information

Safety & Compliance: biamp.com/compliance