

**ALLEN  
&  
HEATH**

*MixWizard Series*

**WZ16:2**

**16 MIC/LINE INPUT AUDIO MIXING CONSOLE**

**USER  
GUIDE**

**PUBLICATION AP2917**

## LIMITED ONE YEAR WARRANTY

This product has been manufactured in the UK by ALLEN & HEATH and is warranted to be free from defects in materials or workmanship for a period of one year from the date of purchase by the original owner.

To ensure the high level of performance and reliability for which this equipment has been designed and manufactured please read this User Guide before operating.

In the event of a failure notify and return the defective unit to ALLEN & HEATH or its authorised agent as soon as possible for repair under warranty subject to the following conditions:

### CONDITIONS OF WARRANTY

1. The equipment has been installed and operated in accordance with the instructions in this User Guide.
2. The equipment has not been subject to misuse either intended or accidental, neglect, or alteration other than as described in the User Guide or Service Manual, or approved by ALLEN & HEATH.
3. Any necessary adjustment, alteration, or repair has been made by ALLEN & HEATH or its authorised agent.
4. The defective unit is to be returned carriage prepaid to ALLEN & HEATH or its authorised agent with proof of purchase.
5. Units to be returned should be packed to avoid transit damage.

These terms of warranty apply to UK sales. In other territories the terms may vary according to legal requirements. Check with your ALLEN & HEATH agent for any additional warranty which may apply.

WZ16:2 User Guide AP2917 Issue 2. copyright © 1998 Allen & Heath. All rights reserved.



This product complies with the European Electromagnetic Compatibility Directives 89/336/EEC & 92/31/EEC and the European Low Voltage Directives 73/23/EEC & 93/68/EEC.



MANUFACTURED IN ENGLAND

ALLEN & HEATH  
Kernick Industrial Estate,  
Penryn, Cornwall, TR10 9LU, UK  
<http://www.allen-heath.com>

ALLEN & HEATH AGENT:

# WELCOME TO THE ALLEN & HEATH *MixWizard WZ16:2*

The **WZ16:2** continues ALLEN & HEATH's commitment to provide high quality audio mixing consoles engineered to meet the exacting requirements of today's audio business. It brings you the latest in high performance technology and offers the reassurance of over two decades of console manufacture and customer support.

This userguide presents a quick reference to the function and application of the **WZ16:2**. For further information on the basic principles of audio system engineering please refer to one of the specialist publications available from bookshops and audio equipment dealers.

Whilst we believe the information in this guide to be reliable we do not assume responsibility for inaccuracies. We also reserve the right to make changes in the interest of further product development.

## SERVICE AND TECHNICAL SUPPORT

Under normal conditions the **WZ16:2** does not require user maintenance or internal calibration. In certain cases it may be necessary to reconfigure internal option links. This and any service work required should be carried out by technically competent service or engineering personnel.

We are able to offer further product support through our worldwide network of approved dealers and service agents. You can also access our Web site on the Internet for information on our product range, assistance with your technical queries or simply to chat about matters audio... To help us provide the most efficient service please keep a record of the console serial number, and date and place of purchase to be quoted in any communication regarding this product.

## CAUTION



**Mains electricity is dangerous and can kill.** Mains voltage is present within the console. Do not remove the covers with mains connected. To ensure your safety the mains earth is connected to the chassis through the power lead. Do not remove this connection.



## PRECAUTIONS

- **POWER SUPPLY** Check the console for correct AC mains voltage setting before switching on. This is marked on the rear panel next to the mains input socket.
- **CONNECTIONS** Use audio connectors and cables only for their intended purpose. Do not connect any source of AC or DC power to the console audio connectors. Do not connect the output of power amplifiers directly to the console.
- **CLEANING** Avoid the use of chemicals, abrasives and solvents. The control panel is best cleaned with a soft brush and dry lint-free cloth.
- **LUBRICATION** The faders, switches and potentiometers are lubricated for life. The use of electrical lubricants on these parts is not recommended.
- **DIRT, DUST, SMOKE and MOISTURE** Prevent damage to the moving parts, such as faders and potentiometers, and cosmetics by avoiding drinks spillage, tobacco ash, smoke, and exposure to rain and condensation. Protect from excessive dirt, dust, heat and vibration.
- **TRANSPORTING the CONSOLE** Ensure that the connector pod is secured in place with the locking screws to prevent movement when transporting the console.

The **WZ16:2** offers the professional user an uncompromised feature set and performance for live sound engineering and recording. Built on the established tradition of innovative British design and manufacture you get a console that is both solidly reliable for a hard life on the road, and uniquely versatile to adapt to any audio mixing application. The **WZ16:2** is equally at home mixing alongside top end live sound consoles such as the ALLEN & HEATH **GL4000**, in theatres, houses of worship, conference and club installations, home and recording studios, or multi-tasking in equipment hire companies. Check out the key features:

- **16 channel inputs for microphone or line sources**

Wide 70dB gain range for loud and soft sources.

Balanced XLR and jack both accept mic or line signals.

+48V phantom power switchable to the XLR inputs. 4-

band EQ with 2 mid frequency sweeps.

100Hz lo-cut filter to remove mic popping and stage rumble.

Channel inserts for plugging in signal processors.

Channel direct outputs for multitrack recording.

6 Aux sends with up to 6dB boost, for 2 pre-fade monitor sends, 2 switched pre or post-fade for monitors or effects, and 2 post-fade for effects sends, recording or broadcast.

Peak LED indicator to warn of signal overload.

100mm long travel faders for smooth control.

- **2 stereo return inputs for effects and replay**

With separate level to L-R and to Aux 1 for the monitor.

- **L-R main output**

Balanced XLRs with inserts and individual 100mm faders.

- **Extra A-B output**

For additional L-R stereo or L+R mono output selectable pre or post L-R faders. Unique underpanel mode switch to configure A-B as a local monitor output for additional stereo or mono monitoring.

- **Engineers monitoring independent of the main outputs**

Stereo headphones output with auto PFL indicated by a large red LED

Monitor switchbank with priority override to select each Aux, Stereo return or L-R (pre or post fader). Auxes can be listened to in stereo pairs.

- **QCC Quick Change Connector system**

Simply hinge the connector pod into position for 1 9" rack or desk operation.

- **MSP Minimum Signal Path for audio transparency**

Carefully designed circuitry to keep the signal path from input to output short using high grade, low noise discrete and IC components.

- **Rugged all metal construction**

Individual circuit assemblies with all rotaries securely bolted to the panel.

No nonsense solid build to ensure on the road reliability.

Here are a few typical **WZ16:2** applications. For clarity, the input sources, signal processing such as EQ, and the amplifiers are not shown:

**PA with Live Recording** - Typical of the up-and-coming band playing the small venue. Simultaneous stereo and multitrack recording for the demo tapes.

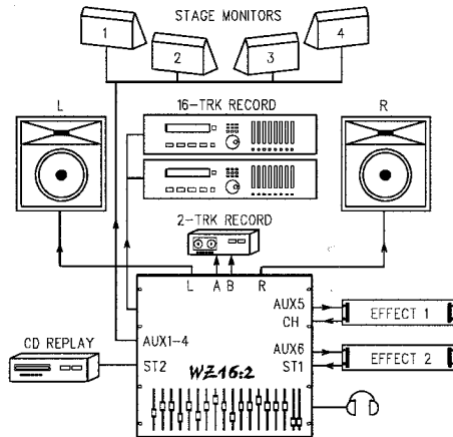

**Studio or Location Recording** - Multitracking up to 16 tracks with stereo mastering and recording. Stereo cue for the performers, and plenty of effects.

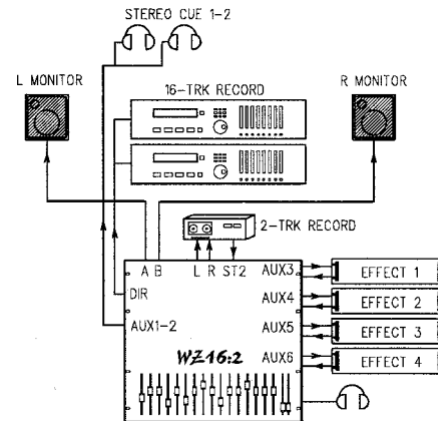

**Extended Speaker System** - Typical in a theatre with a wide stage, and a disco/club. Here, the A-B outputs feed a centre fill speaker and a sub-bass for extended low frequency performance. L and R are combined in mono to drive the centre speaker. Using sub-bass, less power is needed in the L,C,R speakers.

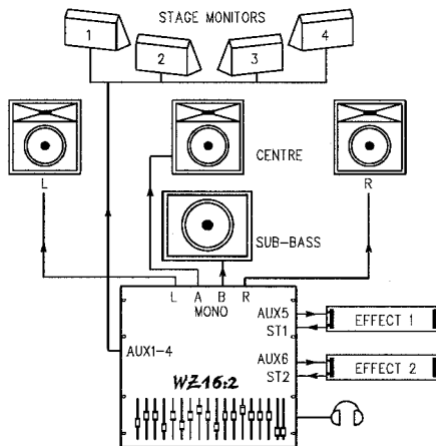

**Small Theatre** - Typical amateur dramatics setup with delay speakers compensating for acoustic delay and improving clarity to the rear of the hall. CD intermission replay, 2-track recording for the performers.

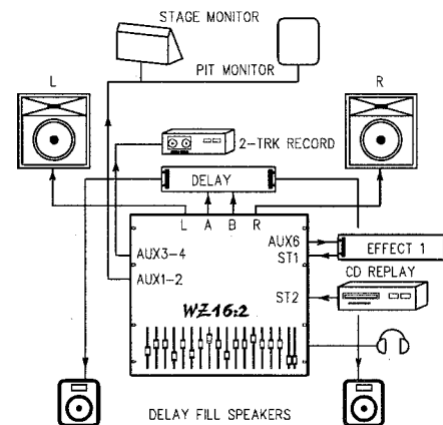

**Houses of Worship** - Increasingly sophisticated sound control is required. Here, a music PA is controlled using L-R, and the congregation PA with delay compensation separately controlled using A-B.

**Dedicated Stage Monitor** - This example shows 4 floor wedges for the musicians and a stereo in-ear monitor for the lead performer. The engineer monitors the signals using a floor wedge similar to the stage monitors.

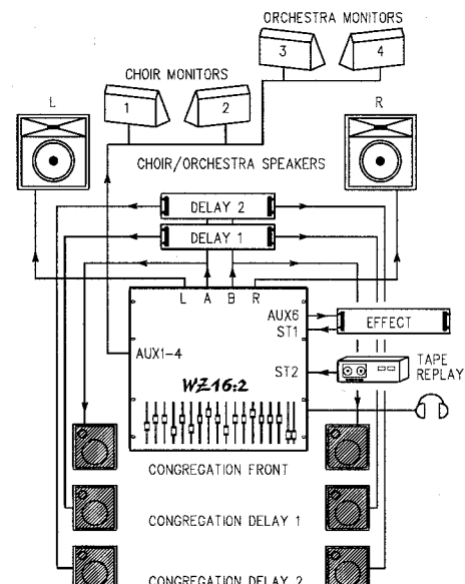
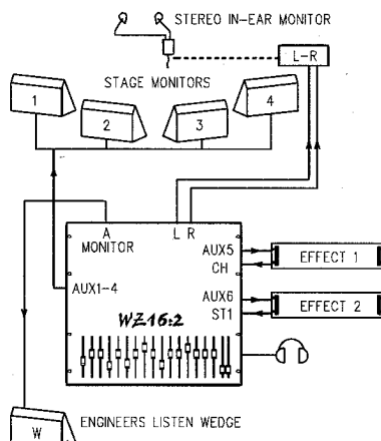

# INSTALLING THE CONSOLE

The **MixWizard Series** features the ALLEN & HEATH Quick Change Connector (QCC) system. The rear connector pod may be hinged and locked into either of two positions: **Rear connectors** for desktop operation with the control panel sloped at a convenient 15 degrees, or **Underside connectors** for 19" rack mounting in a compact 10U space. The connector position can be easily changed at any time to fit your application.

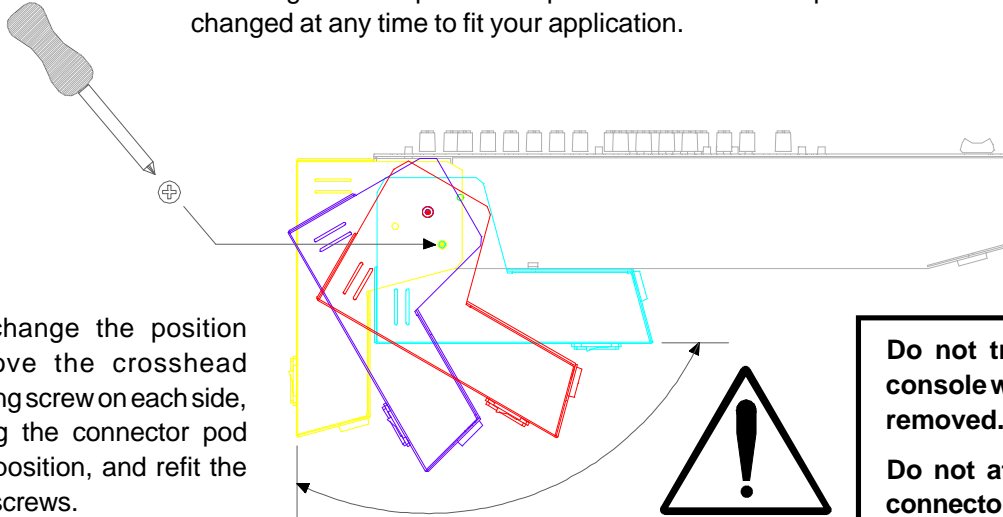

To change the position remove the crosshead locking screw on each side, swing the connector pod into position, and refit the two screws.

**Do not transport or carry the console with the locking screws removed.**

**Do not attempt to remove the connector pod from the console.**

## 19" RACK MOUNTING

Not Suitable For In-Wall Mounting

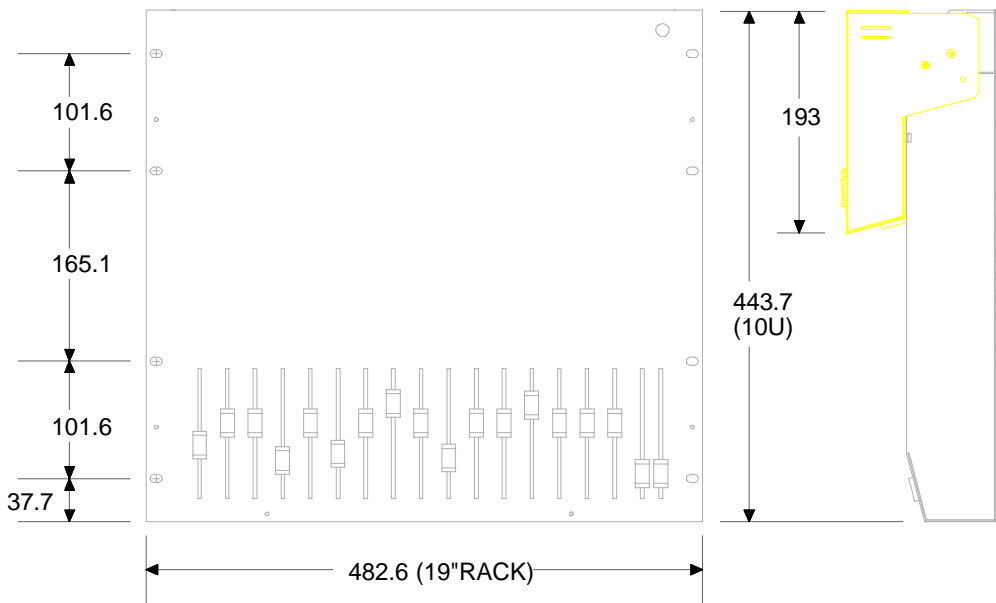

Using a suitable screwdriver, mount the console in the rack using 4x M6 bolts and M6 caged nuts on each side for maximum strength. We recommend you fit the bolts with plastic cup washers to protect the panel. Ensure adequate ventilation by allowing a minimum clearance of 25mm around all sides for unimpeded air flow.

### FLIGHTCASING

The console can be easily flightcased in either connector mode. Provide the dimensions shown here to your flightcase supplier.

### DESKTOP OPERATION

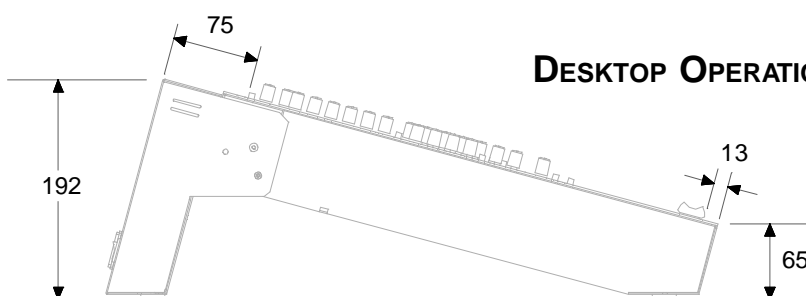

The console is fitted with rubber feet to ensure it does not slip or scratch the work surface. The control panel is angled at 15 degrees for operating convenience.

# CONNECTING MAINS POWER

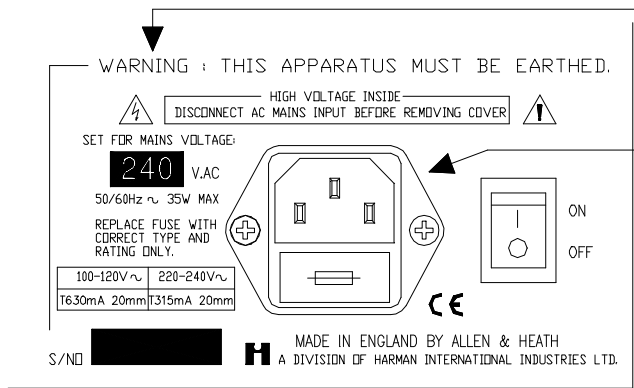

Refer to the **SAFETY WARNING** on page 3 of this User Guide. Check that the voltage indicated on the rear panel is the same as the mains supply in your area. Check that the correct mains lead with moulded plug has been supplied with your console. Read and understand the warnings and instructions printed on the rear panel and shown here.

It is standard practice to turn connected power amplifiers down or off before switching the console on or off. Ensure that the IEC mains plug is pressed fully into the rear panel socket before switching on.

## EARTHING



The connection to earth (ground) in an audio system is important for two reasons:

1. **SAFETY** - To protect the operator from high voltage shock associated with the AC mains supply feeding the system, and
2. **AUDIO PERFORMANCE QUALITY** - To minimise the effect of earth (ground) loops which result in audible hum and buzz, and to shield the audio signals from interference.

For safety it is important that all equipment earths are connected to mains earth so that exposed metal parts are prevented from carrying high voltage which can injure or even kill the operator. It is recommended that the sound engineer check the continuity of the safety earth from all points in the system including microphone bodies, guitar strings, muticore cases, equipment panels ...

The same earth is also used to shield audio cables from external interference such as the hum fields associated with power transformers, lighting dimmer buzz, and computer radiation. Problems arise when the signal sees more than one path to mains earth. An 'earth loop' (ground loop) results causing current to flow between the different earth paths. This condition is usually detected as a mains frequency audible hum or buzz.

To ensure safe and trouble-free operation we recommend the following :

- **Do not remove the earth connection from the mains plug.** The console chassis is connected to mains earth through the power cable to ensure your safety. Audio 0V is connected to the console chassis internally. If problems are encountered with earth loops operate the audio 'ground lift' switches on connected equipment accordingly, or disconnect the cable screens at one end, usually at the destination. It is useful to carry ground lift cable adaptors such as short XLR male to female leads with pin1 disconnected.
- **Avoid running audio cables next to mains, computer or lighting cables,** or near thyristor dimmer and power supply units. If unavoidable, cross these at right angles.
- **Use low impedance sources** such as 200 ohm or less microphones to reduce susceptibility to interference. The console outputs are designed to operate at very low impedance to minimise interference problems.
- **Use balanced connections where possible** as these provide further immunity by cancelling out interference that may be picked up on long cable runs. To connect an unbalanced source to a balanced console input, link the cold input (XLR pin3 or jack ring) to 0V earth (XLR pin1 or jack sleeve) at the console. To connect a balanced console output to an unbalanced destination, link the cold output to 0V earth at the console.
- **Use professional quality cables and connectors** and check for correct wiring and reliable solder joints.
- **If you are not sure ...** Have your system checked by a competent engineer, or contact your local Allen & Heath agent for advice.



# PANEL LAYOUT

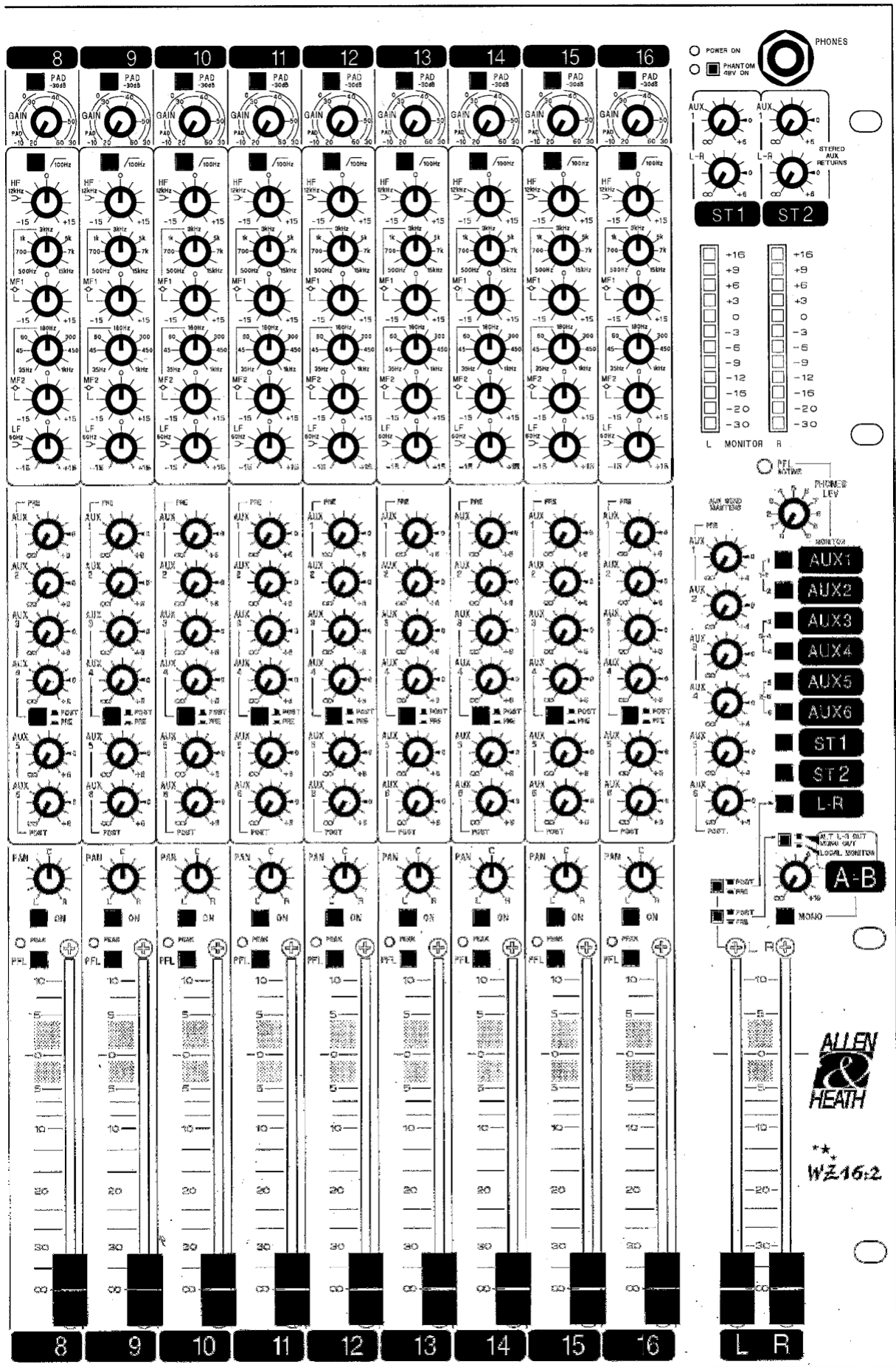

**ALLEN & HEATH**

WZ16.2



# SPECIFICATIONS

0 dBu = 0.775 Volts rms      0 dBV = 1 Volt rms

<p><b>HEADROOM:</b> ..... +21dB channels +23dB mix to output</p> <p><b>MAX OUTPUT:</b>..... XLR +27dBu 600 ohm max load jack +21dBu 2kohm max load</p> <p><b>METERS:</b> ..... L, R..... peak reading 12 segment LED</p> <p><b>PEAK LEDs:</b>..... Turn on 5dB before clipping</p> <p><b>FREQUENCY RESPONSE:</b> 20Hz to 50kHz +0/-1dB</p> <p><b>DISTORTION:</b> THD+Noise at +14dBu 1kHz Channel to mix output.....0.008%</p> <p><b>WEIGHT:</b> unpacked 12kg, packed 14kg</p>	<p><b>CROSSTALK:</b> Referred to driven channel at 1kHz Channel fader off.....&lt;-90dB Channel off .....&lt;-90dB</p> <p><b>NOISE:</b> Measured rms 22Hz to 22kHz bandwidth Mic input EIN referred to 150 ohm source .....&lt;-128dB LR output residual noise.....&lt;-97dBu 101dB S/N LR faders unity mix noise .....&lt;-84dBu 88dB S/N</p> <p><b>POWER SUPPLY:</b>..... internal AC Mains input: IEC socket with lead supplied 100 to 240V AC @ 50/60Hz factory wired to country voltage Power consumption..... 30W max Mains Fuse rating: ..... 100-120VAC use T630mA 20mm 220-240VAC use T315mA 20mm</p>
---	--

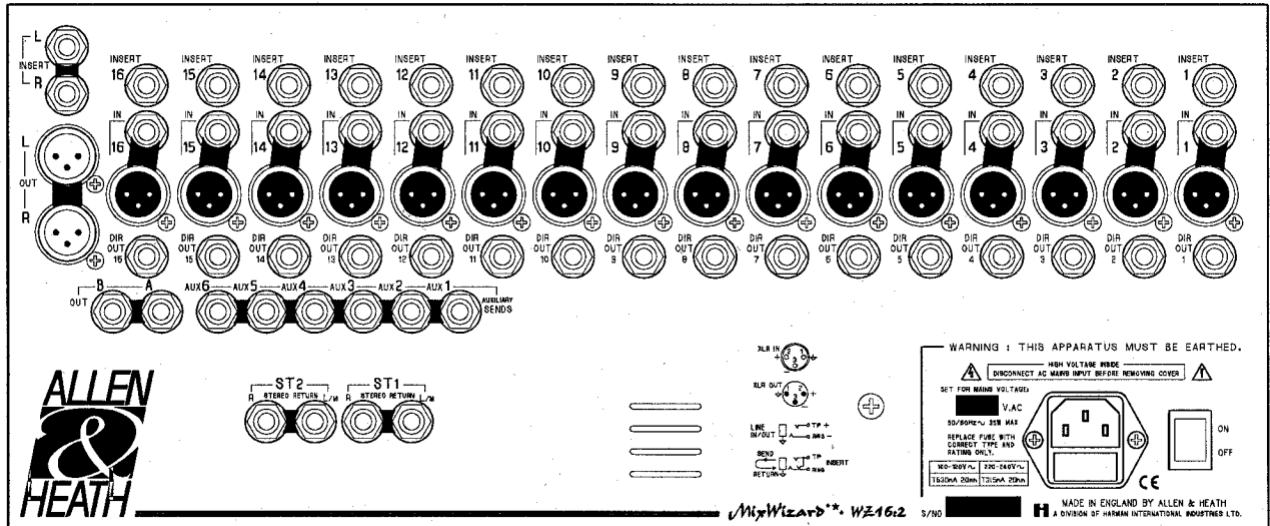

## CONNECTIONS

**INPUTS:**  
 Channel 1-16 IN ..... XLR..... pin 2 hot, 3 cold, balanced  
 TRS jack..... tip hot, ring cold  
 PAD out ..... 2 k ohm ..... variable -60 to -20dBu  
 PAD in ..... >10k ohm..... variable -30 to +10dBu  
 Stereo Return IN..... TRS jack..... tip hot, ring cold ..... >10k ohm..... -10dBV (+4dBu option)

**INSERTS:**  
 Channel 1-16 Insert..... TRS jack..... tip send, ring return, unbal .....<75 ohm, >10k ohm... 0dBu  
 L-R mix ..... TRS jack..... tip send, ring return, unbal .....<75 ohm, >10k ohm.... -2dBu

**OUTPUTS:**  
 L-R main OUT ..... XLR ..... pin 2 hot, 3 cold, balanced .....<75 ohm ..... +4 dBu  
 A-B additional OUT ..... TRS jack..... tip hot, ring cold, impedance bal .....<75 ohm ..... -2dBu  
 Aux 1-6 OUT..... TRS jack..... tip hot, ring cold, impedance bal .....<75 ohm ..... -2dBu  
     Balance option for A-B and Aux 1-6 OUT ..... <75 ohm.....+4dBu  
 Direct 1-16 OUT ..... TRS jack..... tip hot, ring cold, impedance bal .....<75 ohm ..... 0dBu  
 PHONES OUT..... TRS jack..... tip left, ring right ..... for stereo headphones 30 to 600 ohms

# PLUGGING UP THE CHANNELS

The **MixWizard Series** uses professional grade 3-pin XLR and 1/4" TRS jack sockets. We recommend that you use suitable quality cable and connectors and check your leads for reliable soldering and continuity before use. It is well known that most audio system failures are due to faulty interconnecting leads.

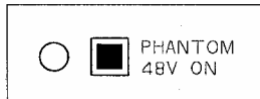
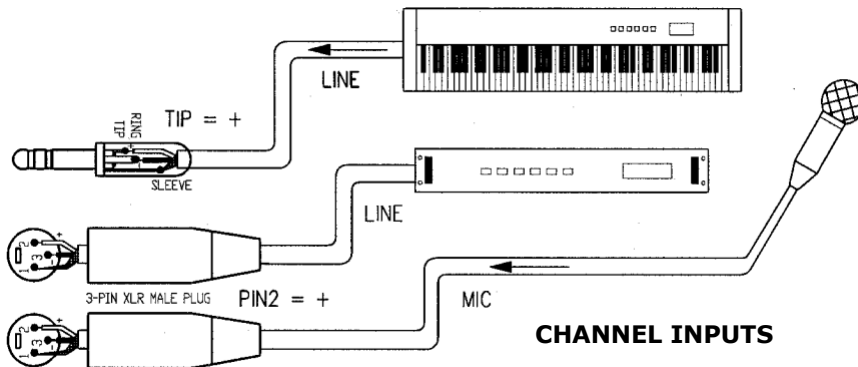
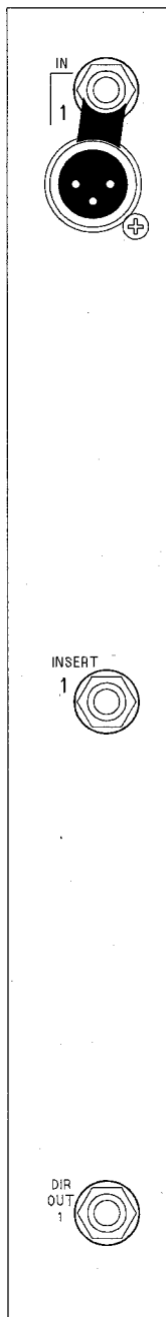

## PHANTOM POWER

Press the underpanel 48V switch if you are using microphones which require phantom power. This feeds +48V to pins 2 and 3 of the XLR inputs. Ensure that you use balanced leads. Note that you can use non powered balanced mics in powered sockets without damage. 48V does not feed the jack inputs.

Both microphone and line sources such as keyboards, replay devices and effects processors can be plugged into either the jack or XLR input for convenience. The channel accepts a wide 70dB range of source levels. The input is a balanced 3-wire to provide the best immunity to interference pickup on long cable runs. However, you can plug in an unbalanced 2-wire source simply by linking the input - (cold) connection to ground (XLR pin3 to pin 1, jack ring to sleeve) in the connector plug.

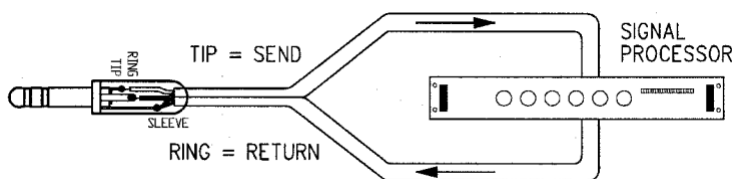

## CHANNEL INSERT

You do not need to plug anything into the channel insert socket for normal operation. However, you may wish to insert a signal processor such as a compressor/limiter or noise gate into the channel signal path to prevent excessive peaks or to cut down source noise. The insert lets you do this by breaking the signal path after the input pre-amp and before the EQ. Use a Y-lead or suitable TRS jack lead to connect to the external processor. The insert operates at 0dBu line level. Adjust the processor input and output levels for optimum signal level.

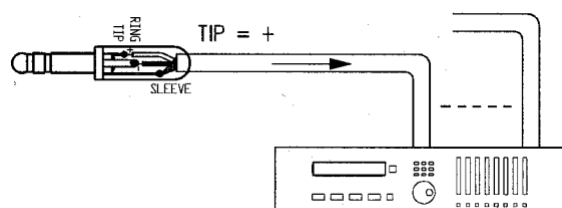

## DIRECT OUTPUT

The channel direct output taps the signal off post-fader (pre-fader if the internal link options is changed) for connection to external processing or recording equipment. This is ideal for multitrack recording during live performance. Here each channel can be recorded on a separate track for mixdown later. The output is impedance balanced on TRS jack. That means that you get the benefit of interference immunity when connecting to a balanced input. You can, of course, also connect to unbalanced equipment. The signal operates at nominal 70dB line level.

# PLUGGING UP THE OUTPUTS

Use these sockets if you wish to insert external signal processing equipment into the L-R mix post-mix amp and pre-L-R fader. This lets you check the effect of the inserted equipment using the console headphones or local monitor. For live sound it is common to insert graphic equalisers to adjust for the room acoustics. In recording you could plug in a compressor to prevent unexpected peaks overloading the recording. Use a suitable stereo jack lead or Y-adaptor for tip = send, ring = return.

## L-R MIX INSERTS

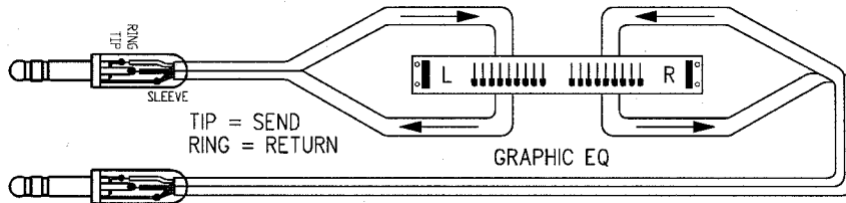
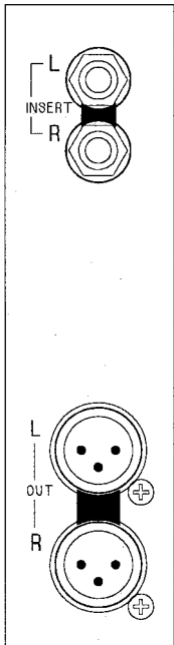

These outputs are 3-wire balanced XLR operating at a nominal +4dBu to drive professional equipment over long cable runs without interference pickup. You can, however, connect to 2-wire unbalanced equipment inputs by linking signal - (cold) to ground (XLR pin3 to pin1). Connect to an amplifier of suitable power rating for the venue to drive the PA loudspeakers. Or connect to a 2-track recorder for studio or location recording.

## L-R MAIN OUTPUTS

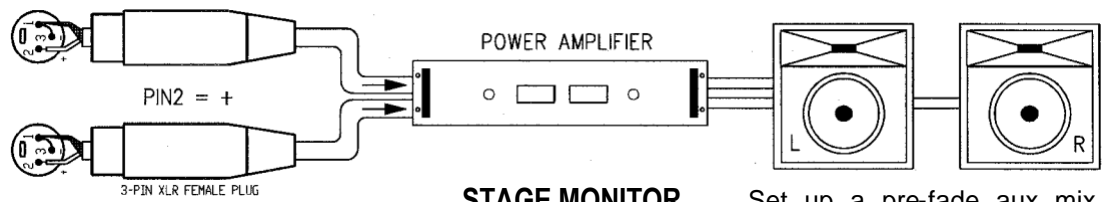

## STAGE MONITOR AND CUE SENDS

Set up a pre-fade aux mix to send a monitor or cue mix to the performers. The aux outputs are 3-wire impedance balanced for interference rejection when plugged into balanced equipment inputs. You could insert a graphic EQ between the output and the amplifier for monitor feedback control.

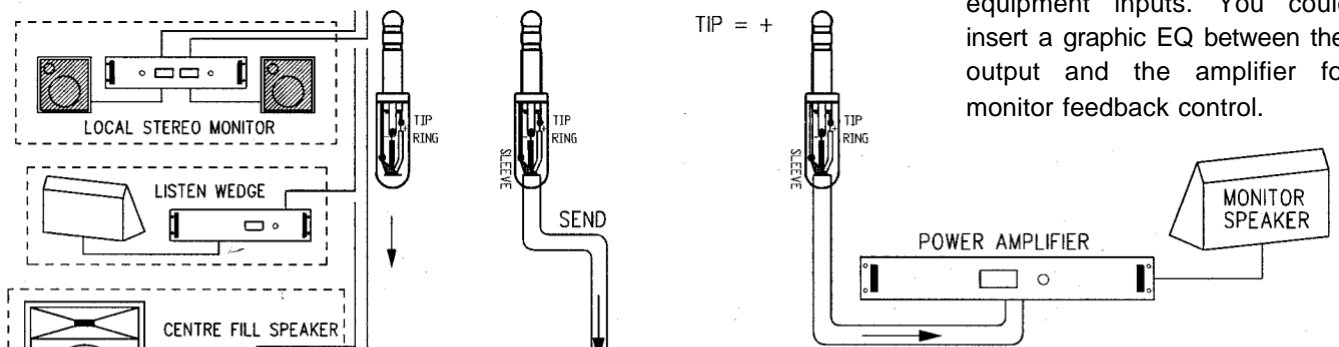
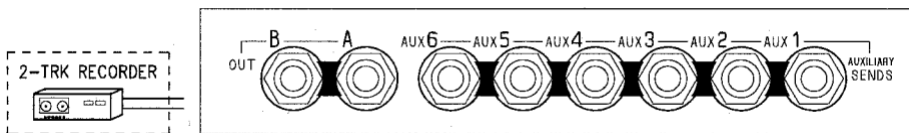

## EFFECTS SEND AND RETURN

Set up a post-fade aux mix to send channel signals to an external effects device such as reverb or delay. Return the processed signal to the mix by plugging the device output into ST1 or ST2 stereo return, or into a channel input. These inputs can operate balanced or unbalanced. For a mono return simply plug into the L input leaving R unplugged. The setting of the channel aux send control determines how much effect is added to the signal.

## 2-TRACK REPLAY

Plug your 2-track recorder into a stereo return to monitor your recording, or for replay over the PA. The return can also be used for intermission replay from a CD player or similar.

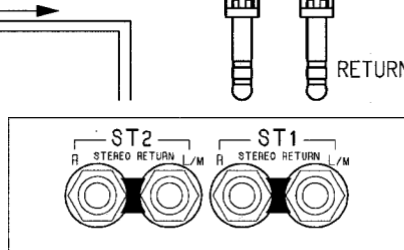

# INPUT CHANNEL

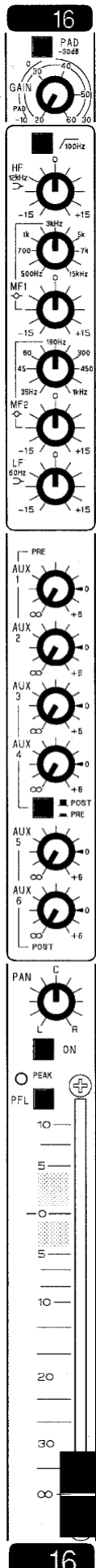

**PAD** - Attenuates the input signal by 30dB. Affects both the XLR and jack inputs. Press this switch when the input signal is too high even with the GAIN control backed off.

**GAIN** - Use this control with the PAD switch to adjust the channel input sensitivity to match the connected source (-60 to +10dBu) to the console operating level (0dBu). Use the PFL function to check that the signal reads an average '0' on the meters.

**100Hz LO-CUT FILTER** - Attenuates frequencies below 100Hz to reduce lowfrequency source noise such as microphone proximity popping, stage noise and transport rumble. Can be used to clean up sounds that do not have much bass content such as vocals.

**EQUALISER** - This provides separate, simultaneous control of 4 frequency bands. Each band may be boosted or cut by up to +/- 15dB. The centre flat position is detented for quick resetting.

The **HF and LF** bands have a shelving response which means that all frequencies beyond the turning pointfrequency are affected, HF = 12kHz, LF = 60Hz. Use HF to add sparkle or to reduce source hiss. Use LF to add punch to the bass instruments. Used with the LO-CUT filter you can tailor the low frequency response exactly as you require.

The two **mid frequency** bands have a peak/dip (bell shaped) response which means that the maximum boost or cut occurs at the selected (centre) frequency. The centre frequency can be swept over a wide range using the SWEEP controls. MF1 = 500Hz to 15kHz, MF2 = 35Hz to 1kHz. Use the mids to add warmth or presence to the sound or to notch out problem resonances that can result in feedback.

**AUXILLIARY SENDS** - You can set up to 6 separately balanced mixes using the aux send controls. Up to +6dB of boost is available.

**Aux 1 and 2** are set pre-fader for **monitor sends** such as stage monitors, backstage, orchestra pit, and musicians recording cue. The amount of channel signal in the monitor mix is independent of the fader level. Pre-fade sends are post-EQ, post-ON as standard (can be reconfigured pre-EQ or pre-ON by setting internal links).

**Aux 3 and 4** are switched pre or post fader for more monitors, effects or separately balanced feeds for **recording and broadcast**.

**Aux 5 and 6** are set post-fader for sends to external **effects** devices such as reverb and delay. The amount of signal sent to the effects device follows the fader level and ON switch. The processed ("wet") signal returned to the mix through the aux return inputs is therefore in proportion to the direct ("dry") signal from the fader to the mix.

**PAN** - Positions the channel signal between L and R in the stereo mix. The centre position (mono image) is detented for quick resetting.

**ON** - This turns the channel signal on or off.

**PEAK** - The red LED lights when the signal is within 5dB of clipping. Should this occur turn back the GAIN control to reduce the signal level.

**PFL** - Press PFL to listen to the pre-fade signal on headphones or local monitor without affecting the main outputs. The signal level is shown on the L and R bar meters. The PEAK LED half lights to show which channel PFL has been selected.

# STEREO RETURNS

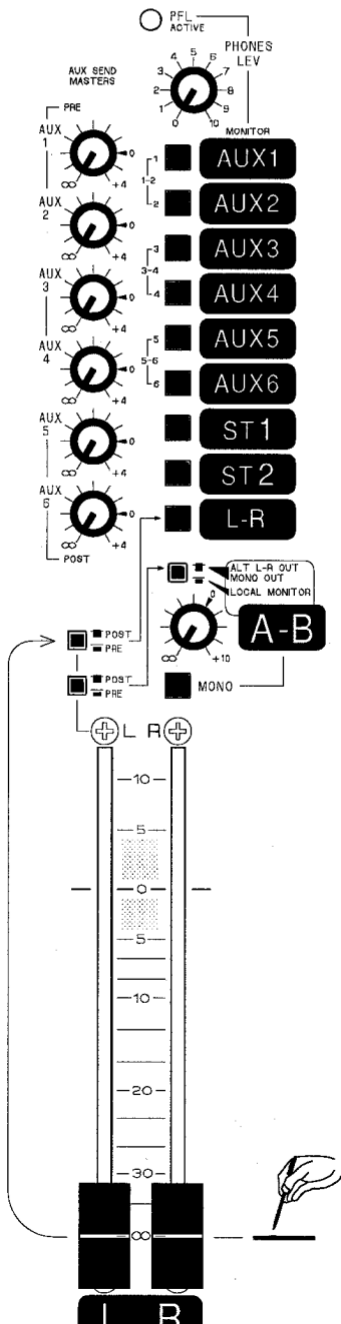
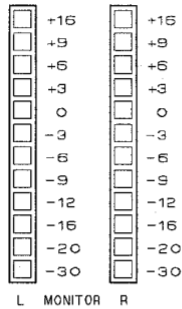
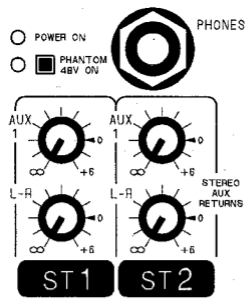

Two stereo return inputs **ST1** and **ST2** are provided giving you a total of 20 inputs to the L-R mix. These may be used for returning the processed signal from the effects devices, monitoring and replaying your 2-track recording, expander or submix inputs, or for stereo intermission replay.

**AUX1 LEV** - Sends the return signal (L and R combined into mono) to the Aux1 mix independent of the level to the main mix. This lets you feed effects to the performers monitor. When using the return for 2-track replay you can replay the recording to the performers cue. Up to +6dB boost is available.

**L-R LEV** - Adjusts the return signal level to the L-R mix.

# MASTERS

**AUX MASTERS** - Each aux mix has a master level control that adjusts the output level to match external equipment, or to trim the monitor, effect or recording level without affecting the mix balance. Up to +4dB of boost is available above the nominal '0' position.

**L-R FADERS** - Individual 100mm faders adjust the main L-R mix level with +10dB boost available above the nominal '0' position. For best performance the faders should be operated around the '0' position for normal 'loud' level. If you find yourself operating significantly below '0' then the amplifier or recorder input is too sensitive for the console +4dBu output. Simply turn down the amplifier or recorder level trim. If none is available then insert an attenuator pad between the console and connected equipment.

# MONITOR

**PFL** - A large red LED lights when any channel PFL switch is pressed. The PFL signal overrides any selected monitor source.

**MONITOR SWITCHBANK** - 9 switches select which source you listen to on the headphones and view on the L,R meters. These include Aux1-6, ST1 and ST2 in stereo, and L-R. It is useful to be able to turn off L-R in the monitor so that headphones spill does not cause a distraction during live mixing.

Priority works from the top of the switchbank down as follows: PFL interrupts Aux, interrupts ST1, interrupts L-R

For example, you can select L-R to monitor your mix, then press ST1 to interrupt L-R with your 2-track replay, then press an Aux to check a monitor. Pressing any PFL always takes priority.

Auxes can be monitored in mono or as combined stereo pairs. For example, press Aux1 for mono, press Aux1 and Aux2 together to monitor Aux1-2 as a stereo pair. Pressing Aux3 overrides the Aux1-2 monitoring, and so on. This is most useful when you set up stereo cue or recording sends.

**L-R POST/PRE** - This switch is recessed to prevent accidental operation. It should be operated with a pen tip or other sharp object. In the normal up position pressing the L-R monitors the main mix post-fader. When down, L-R is monitored pre-fader so that you can monitor the mix unaffected by the L-R fader positions.

# OPTIONS

The **MixWizard Series WZ16:2** has a versatile architecture designed to satisfy most live sound or recording applications you may encounter without modification. However, the following internal options are offered to provide alternative settings for those applications that may demand them. These options require resoldering of circuit board links and should only be carried out by competent technical personnel. Further information is available from your service agent or the **WZ16:2 SERVICE MANUAL**.

## PHANTOM POWER DISABLE

It is perfectly safe to connect non-phantom powered sources such as dynamic microphones to powered XLR sockets providing that balanced leads and sources are used. The +48V supply is current limited through 6.8k ohm resistors to each XLR to prevent damage. However, you can disable phantom power to selected channels by cutting out links on the rear connector circuit assembly. This work should be referred to your service agent.

## ST1, ST2 INPUT SENSITIVITY

The stereo return inputs are set for nominal low level -10dBV operation as is common with much of the external equipment available today. The console level controls let you adjust for varying input levels. Most outboard equipment include output level trims. If, however, you wish to change the sensitivity to high level +4dBu the rear connector circuit can be reconfigured. This work should be referred to your service agent.

## AUX OUT AND A-B OUT BALANCE OPTION

These outputs are impedance balanced on TRS jack to provide interference rejection when plugged into equipment with balanced inputs. It should not normally be necessary to fit the electronic balance option available. This option also increases the output level to a nominal +4dBu. Refer this work to your service agent.

## CHANNEL PRE-FADE AUX SEND OPTIONS

The pre-fade sends are set post-EQ and post-ON as standard. However, link options on each channel assembly allow pre-EQ and/or pre-ON if required. This is shown in the diagram below.

## CHANNEL DIRECT OUTPUT SOURCE

The direct outputs are sourced post-fader as standard. A link option is available per channel to select a pre-fade source. This is shown in the diagram below.

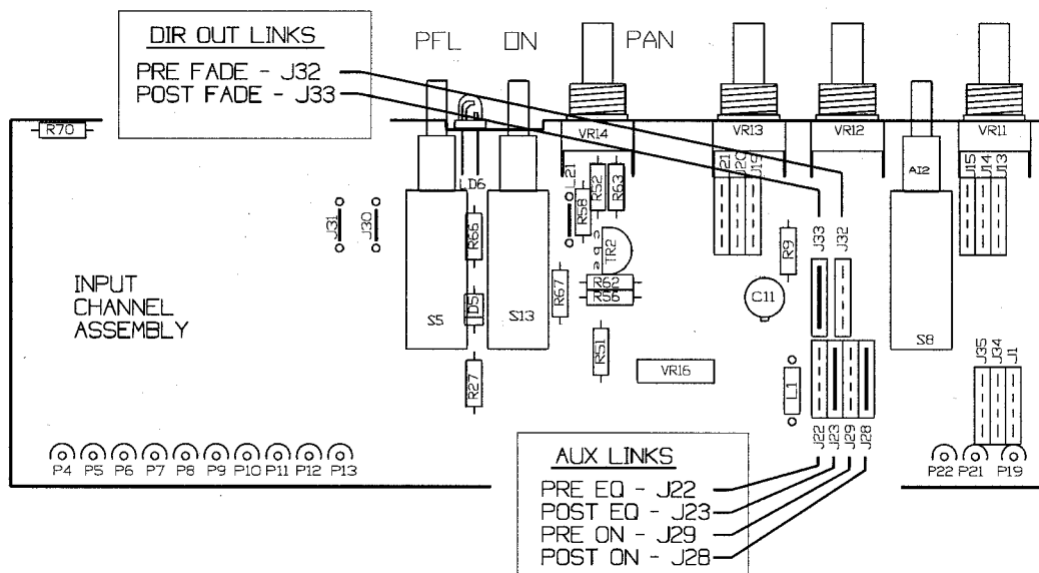

# A-B OUTPUT

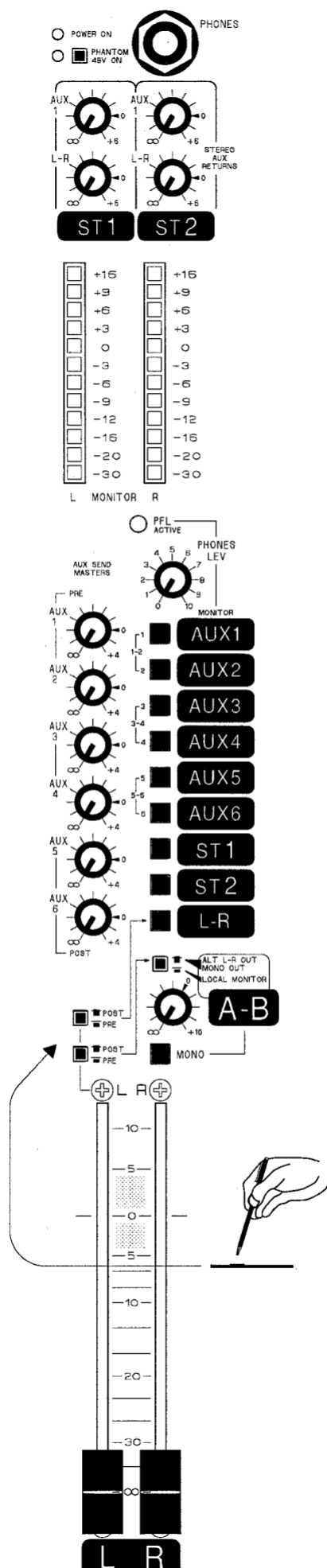

The A-B output is an additional stereo/mono output that can be uniquely configured as either a **separately controllable mix** output, or a **local loudspeaker monitor** feed.

**MODE SWITCH** - This switch is recessed under the panel to prevent accidental operation. It is operated using a pen tip or similar pointed object. In the normal up position A-B follows the main L-R mix. When pressed A-B follows the monitor switchbank + PFL to become a 'local' monitor in addition to the headphones.

**POST/PRE** - This recessed switch selects whether the L-R signal fed to A-B is sourced pre or post the L-R faders.

**LEVEL** - Adjust the output level using this control. Up to +10dB of boost is available above the nominal '0' position.

**MONO** - Sums L+R into mono. When A-B is configured as an additional mix output the MONO switch provides a mono output ideal for centre fill or sub-bass loudspeaker systems, or mono recording and broadcast feeds. When A-B is configured as a local monitor the MONO switch lets you check the mono compatibility of the selected mono source. Alternatively you can feed a local mono speaker monitor such as an engineers listen wedge.

Here are a few applications of the versatile A-B output:

## A-B

### L-R stereo live recording / broadcast

mode = up, set pre-fade  
level trim to match recorder, L and R out

### Mono live recording / broadcast

mode = up, set pre-fade, mono selected  
level trim to match recorder, 2x M out

### Additional L-R zone speakers

mode = up, set pre or post fade  
level trim to balance speakers, L and R out

### L-R delay fill speakers

mode = up, set post-fade  
level trim to balance to main, L and R out

### Mono centre fill speaker

mode = up, set post-fade, mono selected  
level trim to balance to main, 2x M out

### Sub-bass speaker

mode = up, set post-fade, mono selected  
level trim to balance to main, 2x M out

### Local stereo speaker monitor

mode = down  
separate monitor level, L and R out

### Local floor listen wedge monitor

mode = down, mono selected  
separate monitor level, 2x M out



# MixWizard<sup>™</sup> WZ16:2

