

ALLEN&HEATH

QU-PAC



Getting Started Guide

For Firmware Version V1.9

i Before starting please check www.allen-heath.com for the latest Qu-Pac firmware and documentation.

Publication AP9815

Limited One Year Manufacturer's Warranty

Allen & Heath warrants the Allen & Heath -branded hardware product and accessories contained in the original packaging ("Allen & Heath Product") against defects in materials and workmanship when used in accordance with Allen & Heath's user manuals, technical specifications and other Allen & Heath product published guidelines for a period of ONE (1) YEAR from the date of original purchase by the end-user purchaser ("Warranty Period").

This warranty does not apply to any non-Allen & Heath branded hardware products or any software, even if packaged or sold with Allen & Heath hardware.

Please refer to the licensing agreement accompanying the software for details of your rights with respect to the use of software/firmware ("EULA").

Details of the EULA, warranty policy and other useful information can be found on the Allen & Heath website: www.allen-heath.com/legal.

Repair or replacement under the terms of the warranty does not provide right to extension or renewal of the warranty period. Repair or direct replacement of the product under the terms of this warranty may be fulfilled with functionally equivalent service exchange units.

This warranty is not transferable. This warranty will be the purchaser's sole and exclusive remedy and neither Allen & Heath nor its approved service centres shall be liable for any incidental or consequential damages or breach of any express or implied warranty of this product.

Conditions of Warranty

The equipment has not been subject to misuse either intended or accidental, neglect, or alteration other than as described in the User Guide or Service Manual, or approved by Allen & Heath.

Any necessary adjustment, alteration or repair has been carried out by an authorised Allen & Heath distributor or agent.

The defective unit is to be returned carriage prepaid to the place of purchase, an authorised Allen & Heath distributor or agent with proof of purchase. Please discuss this with the distributor or the agent before shipping. Units returned should be packed in the original carton to avoid transit damage.

DISCLAIMER: Allen & Heath shall not be liable for the loss of any saved/stored data in products that are either repaired or replaced.

Check with your Allen & Heath distributor or agent for any additional warranty information which may apply. If further assistance is required please contact Allen & Heath Ltd.

Any changes or modifications to the equipment not approved by Allen & Heath could void the compliance of the product and therefore the user's authority to operate it.



Qu Series products comply with the European Electromagnetic Compatibility directive 2004/108/EC and the European Low Voltage directive 2006/95/EC.

Qu-Pac Getting Started Guide AP9815 Issue 4

Copyright © 2016 Allen & Heath. All rights reserved

ALLEN & HEATH

Allen & Heath Limited, Kernick Industrial Estate, Penryn, Cornwall, TR10 9LU, UK

<http://www.allen-heath.com>

IMPORTANT - Read these instructions before starting:

Safety instructions

Before starting, read the [Important Safety Instructions](#) printed on the sheet supplied with the equipment. For your own safety and that of the operator, technical crew and performers, follow all instructions and heed all warnings printed on the sheet and on the equipment panels.

System operating firmware

The function of the Qu mixer is determined by the firmware (operating software) that runs it. Firmware is updated regularly as new features are added and improvements made. The firmware version current when this guide was released is noted in the Contents section.

The latest firmware can be downloaded from the Allen & Heath website, transferred to USB key and then loaded into the Qu mixer using the Firmware Update utility. Read the Release Notes that come with the firmware.

- **Check the Allen & Heath website for the latest version of Qu-Pac firmware.**

Software licence agreement

By using this Allen & Heath product and the software within it you agree to be bound by the terms of the relevant [End User Licence Agreement](#) (EULA), a copy of which can be found on the Allen & Heath website (www.allen-heath.com/legal). You agree to be bound by the terms of the EULA by installing, copying, or using the software.

Further information

Please refer to the [Allen & Heath website](#) for further information, knowledgebase and technical support. You can join our Allen & Heath Digital Community to share knowledge and information with other Qu users.

- Check for the latest version of this Getting Started Guide.
- Download the [Qu Series Reference Guide AP9372](#).

General precautions

- To prevent damage to the controls and cosmetics, avoid placing heavy objects on the control surface, scratching the surface or touch screen with sharp objects, or rough handling and vibration.
- Protect the equipment from damage through liquid or dust contamination. Cover the mixer when it is not being used for a long period.
- Computer and touch screen technology can be affected by extreme cold. If the equipment has been stored in sub-zero temperatures allow time for it to reach normal operating temperature before use at the venue. Recommended operating temperature for Qu is 5 to 35 degrees Celsius.
- Avoid using the equipment in extreme heat and direct sunlight. Make sure the mixer ventilation slots are not obstructed and that there is adequate air movement around the equipment.
- Clean the surface with a soft brush and dry lint-free cloth. Do not use chemicals, abrasives or solvents.
- It is recommended that servicing is carried out only by an authorised Allen & Heath agent. Contact details for your local distributor can be found on the Allen & Heath website. Allen & Heath do not accept liability for damage caused by maintenance, repair or modification by unauthorised personnel.

1. Packed contents

Qu-Pac Mixer

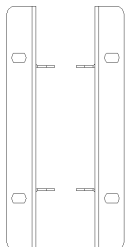
19" Rack Ears and screws
 AA9848-L and AA9848-R
 4x AB0344 M6x16 screws
 4x AB0345 M6 cups
 4x AB0332 M4x8 screws



Getting Started Guide AP9815



Safety Sheet
 AP9240/CL-1

- Read this before starting



Mains lead

- Check this is correct for your territory

Options and Accessories available

Remote Audio Racks
 Provides remote audio over dSNAKE Cat5 cable digital snake.

AR2412 24 Mic/Line in, 12 Line out
 Part: GLD-AR2412



AR84 8 Mic/Line in, 4 Line out
 Part: GLD-AR0804



AB168 16 Mic/Line in, 8 Line out Remote AudioRack.
 Part: AB1608



Cat5 cables
 For use with dSNAKE remote audio



AH8823 2m (6.6') short patch
 AH9651 20m (66') coil
 AH9981 50m (165') drum
 AH9650 100m (330') drum

LEDlamp
 Right angled 4-pin XLR LED lamp with built-in dimmer
 Part: LEDlampX



ME Personal Mixing System
 ME-1 Personal Mixer
 ME-U 10-port PoE hub



Qu-Pad app for iPad
Qu-You app for iOS devices & Android
Qu-Control app for iOS devices
 Available from the Apple Store / Google Play

Qu-Pac polyester carry bag
 Part AP9933



REGISTER YOUR PRODUCT online at: www.allen-heath.com/register

2. Contents

1.	Packed contents	4
2.	Contents	5
3.	Introduction to Qu-Pac.....	6
4.	Installing Qu-Pac	7
5.	Rear Panel	8
5.1	Connecting and powering up the mixer.....	8
6.	Front Panel	9
7.	Audio Signal Processing.....	10
8.	Wireless Control	11
9.	Qu-Start	12
9.1	Things to check before starting:	12
9.2	Set a known starting point:	12
9.3	Prepare the mixer for your session:	13
9.4	Set a starting point for processing and mix parameters:	15
9.5	Save the settings:.....	16
9.6	Mixing with Qu-Pac:	17
9.7	The Qu-Control screen.....	19
9.8	Security and user access.....	19
9.9	USB recording and playback:.....	20
9.10	A few more functions	21
10.	Resetting the Mixer	22
10.1	Reset Mix Settings – A starting point for mixing.....	22
10.2	System Hard Reset – Clear everything	22



About this guide

This is the Getting Started Guide for the Allen & Heath Qu-Pac rack mount digital mixer. For more information about Qu-Pac setup and mixing functions please refer to the **Qu Mixer Reference Guide** available for download from www.allen-heath.com

Please Note - This guide refers to Qu firmware **V1.9**. Please refer to the Allen & Heath website for the latest version of firmware and this guide. For information on the **AR2412**, **AR84** and **AB168** remote AudioRacks please refer to their user guides.

3. Introduction to Qu-Pac



Qu-Pac is part of the Allen & Heath Qu Series of digital mixers. It is a faderless version with the same local connections as the Qu-16, but features the Qu-32 mix engine and can therefore be expanded to a full 32 channels using an optional AudioRack linked via the dSNAKE Cat5 digital snake. Qu-Pac is intended for wireless live mixing, for example using an iPad. It can also be fully controlled using its front panel touch screen. Qu-Pac has many applications where a compact solution is required:

- Compact live mixer for wireless remote mixing
- Band mixer for side-of-stage live mixing, personal monitoring, live and DAW multitrack recording
- Installed mixer with user logins for live event technician and zone control by non-technical staff
- Corporate event mixing complete with built-in automatic mic mixer (AMM)
- Free standing or 19" 4U rack mount (rack ears supplied)
- 16 Mic/Line inputs expandable to 32 via dSNAKE (digital snake and optional AudioRacks)
- 3 stereo Line inputs, 12 mixes (4 mono, 3 stereo, LR), 4 stereo groups, 2 stereo matrix
- Ability to convert groups to additional mixes (up to 4 mono and 7 stereo monitors)
- 4 internal FX engines with dedicated return channels
- 4 Mute groups, 4 DCA groups
- Input processing – Preamp, HPF, Gate, PEQ, Compressor, Delay, Ducking
- Output processing – PEQ, Graphic EQ, Compressor, Delay
- 100 Scene memories with recall filters, safes and USB data transfer
- Qu-Drive for stereo and 18-track recording/playback to USB hard drive
- 32 in, 32 out USB streaming, MIDI DAW control
- Qu-Pad engineer's mixing wireless remote app for iPad
- Qu-You personal monitoring app for iPhone, iPad, iPod Touch, Android
- Qu-Control customisable control app for iPhone, iPad, iPod Touch
- Compatible with the Allen & Heath ME personal mixing system
- Customisable 15 SoftKeys, 16 Sel keys, Qu-Control screen
- User permissions and login to enable operator access

4. Installing Qu-Pac



Free Standing - For operating while on a desk, shelf or other flat surface.

Make sure the 4 rubber feet are fitted.

Allow space at the sides and rear for ventilation.

The mixer can be transported in a purpose designed padded bag or flight case.

Optional polyester Qu-Pac padded carry bag AP9931 is available from Allen & Heath.



Rack Cased - For operating while fitted into a 4U space in a standard 19" equipment rack or flight case.

Choosing a 'shallow' case with internal depth of 200mm (8") or more to allow easy access to the rear connectors.

The mixer front panel is angled upwards to allow easier access to the controls while in the rack.

Qu-Pac is shipped with a rack ear kit to convert from free standing to rack operation. To fit the rack ears:

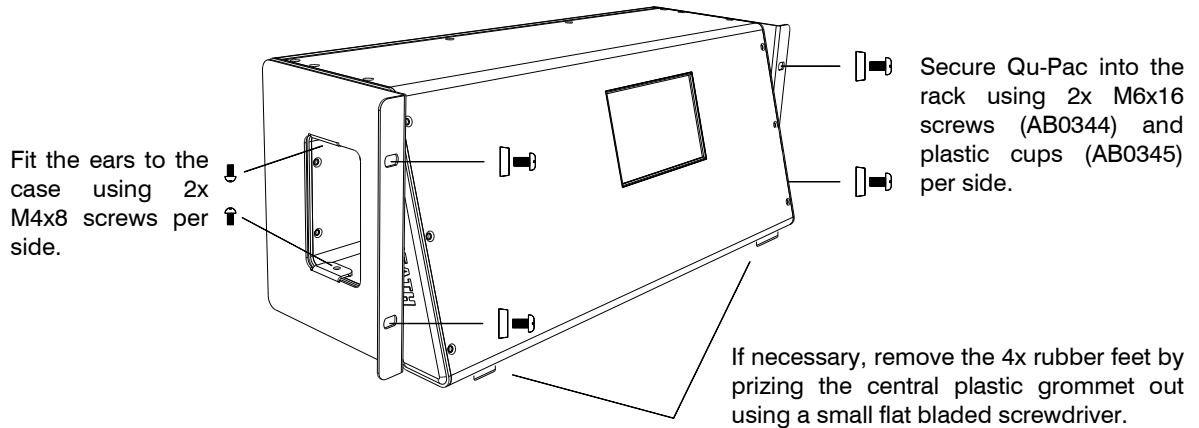

i - Allow adequate air flow around the ventilation slots at the rear and through the inside section of the case. Do not block the sides.

Dimensions - Shown in millimetres (inches)

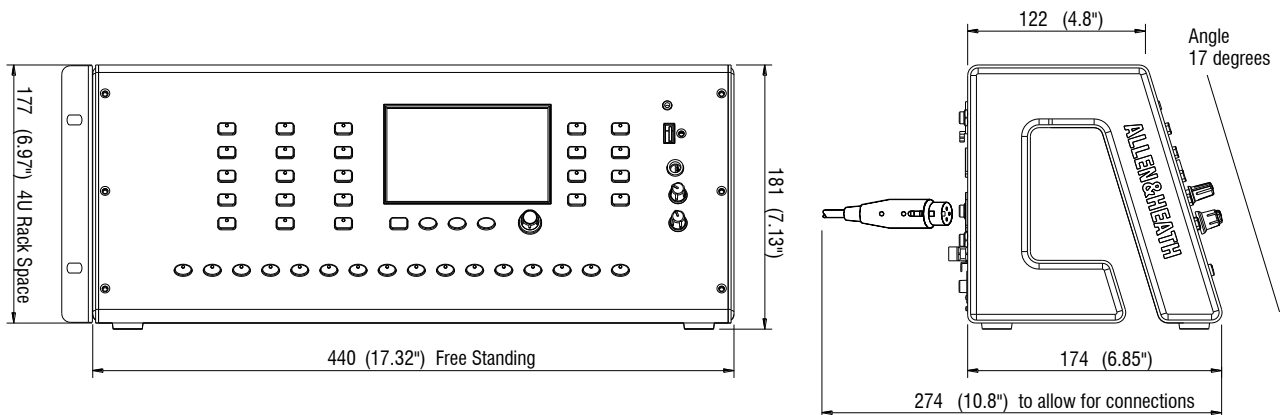

5. Rear Panel

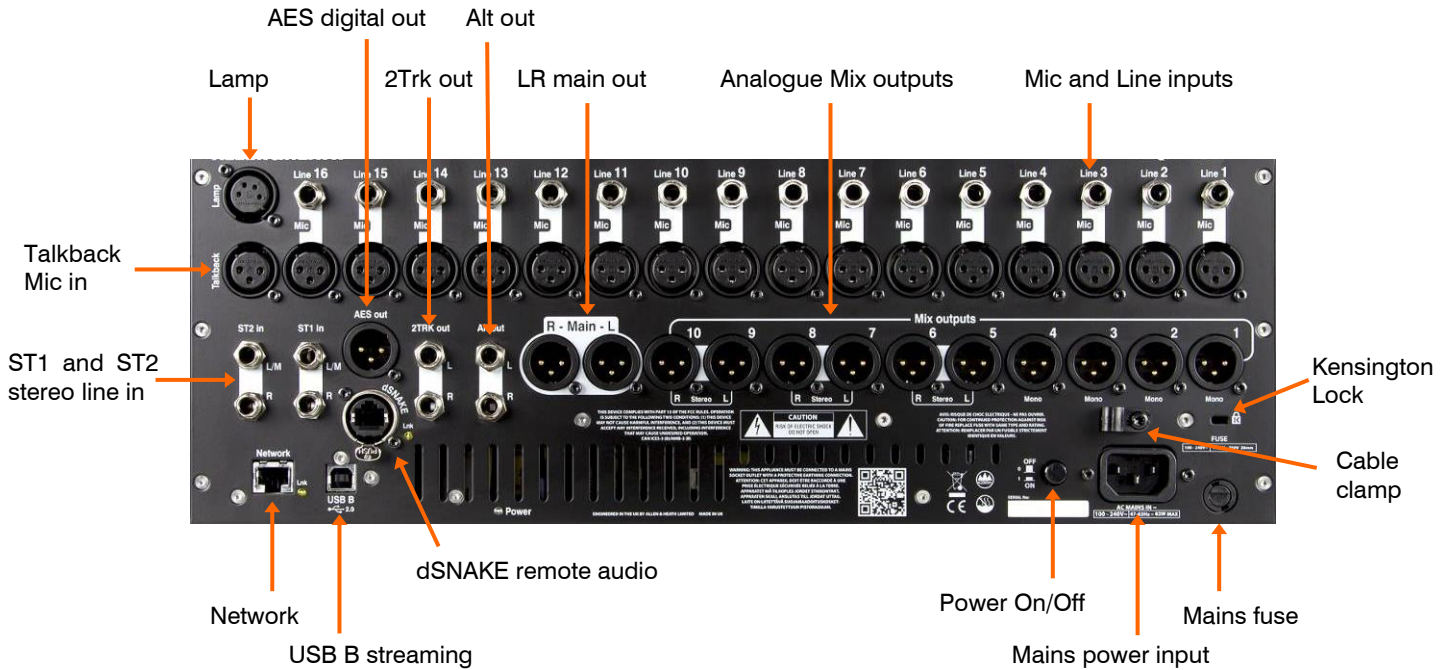

5.1 Connecting and powering up the mixer

If you are using a remote AudioRack then connect it with a Cat5 digital snake. Use STP (shielded twisted pair) Cat5e or higher spec cable up to 100m (330') long. Cable with both foil and braided screens provide shielding from interference and are generally more rugged. Stranded core cables are less prone to damage when kinked or repeatedly coiled. Plug into the dSNAKE port. If you are connecting a second AudioRack connect it to the EXPANDER port of the first.



Once an AudioRack is recognised, the dSNAKE icon will appear in the screen toolbar:

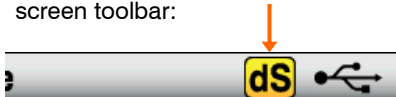

ⓘ Important - Before starting, read the **Safety Instructions Sheet** packed with the mixer. These can also be downloaded from the Allen & Heath website.

ⓘ To avoid loud thumps, do not switch the mixer on or off while the PA speakers are powered. Always switch the amplifiers on last, and switch them off first.

Switching the mixer on – Press the ON/OFF switch. The mixer takes just a few seconds to boot up. It restores its previous settings. LR mix is selected and it's processing shown on the screen.

Switching the mixer off – First select the **Home** screen. Touch **Shut Down** to safely complete processes such as parameter storing and USB data transfer or recording. Once complete, press the ON/OFF switch to turn the mixer off.

6. Front Panel

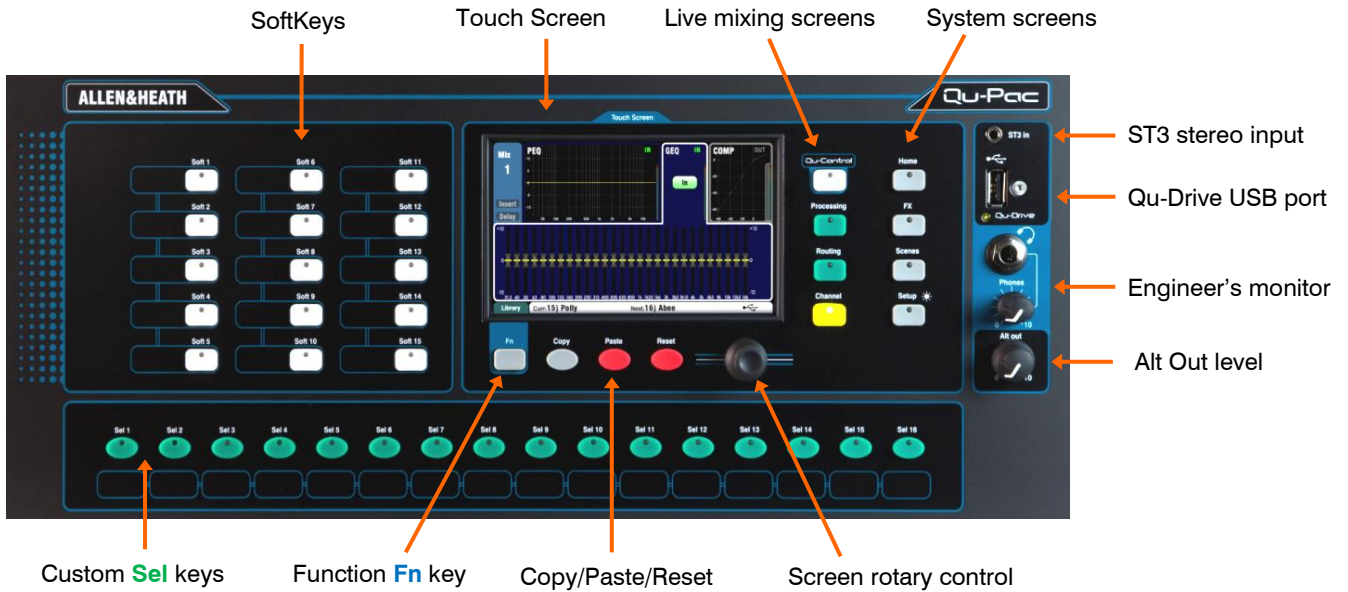

Live mixing screens - Provide quick access to live mixing functions such as level control and signal processing:

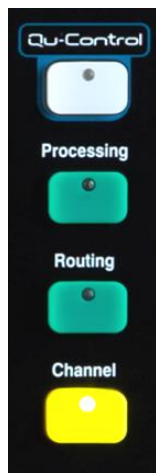

Qu-Control - User assignable custom screen for simple level, mute and on/off control. A user permission can be set so that this is the only control available to the 'Basic User', for example bar staff control of zone music source and level at a venue.

Processing - Follows the active **Sel** key or button to open the signal processing screens. This includes the Preamp, Gate, Ducker, PEQ, GEQ, Compressor, Delay, FX parameters and more.

Routing - Follows the active **Sel** key or button to open the routing assignment and related option screens.

Channel - This is the main screen for live mixing. It follows the active **Sel** key or button to open a virtual 'fader strip' on screen. This replaces the physical faders of the other Qu mixer models. It provides a way to work with the faders when mixing from the front panel.

The Channel screen presents tabs and Sel buttons to access any Qu input or output channel, and the DCA and Mute Group masters.

System screens - Provide access to the mixer setup, Qu-Drive recording and memories:



Home - Pages of housekeeping functions including safe Shut Down, Lock Surface, change and set up User Profiles, view Meters and RTA, and work with Qu-Drive stereo and multitrack recording and playback.

FX - View, load and set up the 4 internal effects units. The Back Panel view lets you patch each unit as inserted or send/return. These can provide reverbs, delay and modulation effects types.

Scenes - Name, store and recall to/from 100 Scene memories. You can block selected parameters from scene recall by setting the global or per-scene Filters. You can protect selected channels from being overwritten by making them scene recall Safe.

Setup - Pages to configure Qu-Pac. Includes PAFL options, Talkback, Signal Generator, Custom Sel keys, SoftKeys, Network, MIDI, Output Patching and more. You can transfer Scene, Library and Show data to a USB storage device, calibrate the screen, format a USB drive for recording, and update the mixer firmware.

Press and hold the Setup key and turn the screen Rotary for the dimmer function to adjust screen and indicator brightness.

Custom Select keys - 16 **Sel** keys can be user assigned for quick access to any combination of channels, masters, DCA groups and MIDI strips. For example, assign only those that you are using for your show. You can view their fader levels and meters using the **Channel / Custom** screen. Space is provided for a label strip.

Copy/Paste/Reset – These let you copy or reset processing or mix parameters. To Copy, hold down the Copy key and press the key or touch the screen button associated with the parameters you wish to copy. Then hold down the Paste key and press the key or touch the button for the channel or mix you wish to copy to. To Reset, hold down the Reset key and press an associated key or button:

- + **Sel** key or button = All its processing - HPF, Gate, PEQ, GEQ, Comp, Delay
- + **Mix** select button = Send levels, Pans, Assign (not pre/post settings)
- + Touch top of processing screen = Just the associated processing block
- + touch Scene item in list = Scene name, contents and filter

Fn key – Press to open an option page for the currently selected screen. Its function is displayed in the lower toolbar. For example, access the input source patching from the **Processing** screen Preamp page, or the Mute and DCA Groups from the **Routing** screen.

7. Audio Signal Processing

The following diagram shows the available Qu-Pac signal flow and processing. A more detailed diagram and further information is available within the Qu Mixer Reference Guide which can be downloaded from the Allen & Heath website.

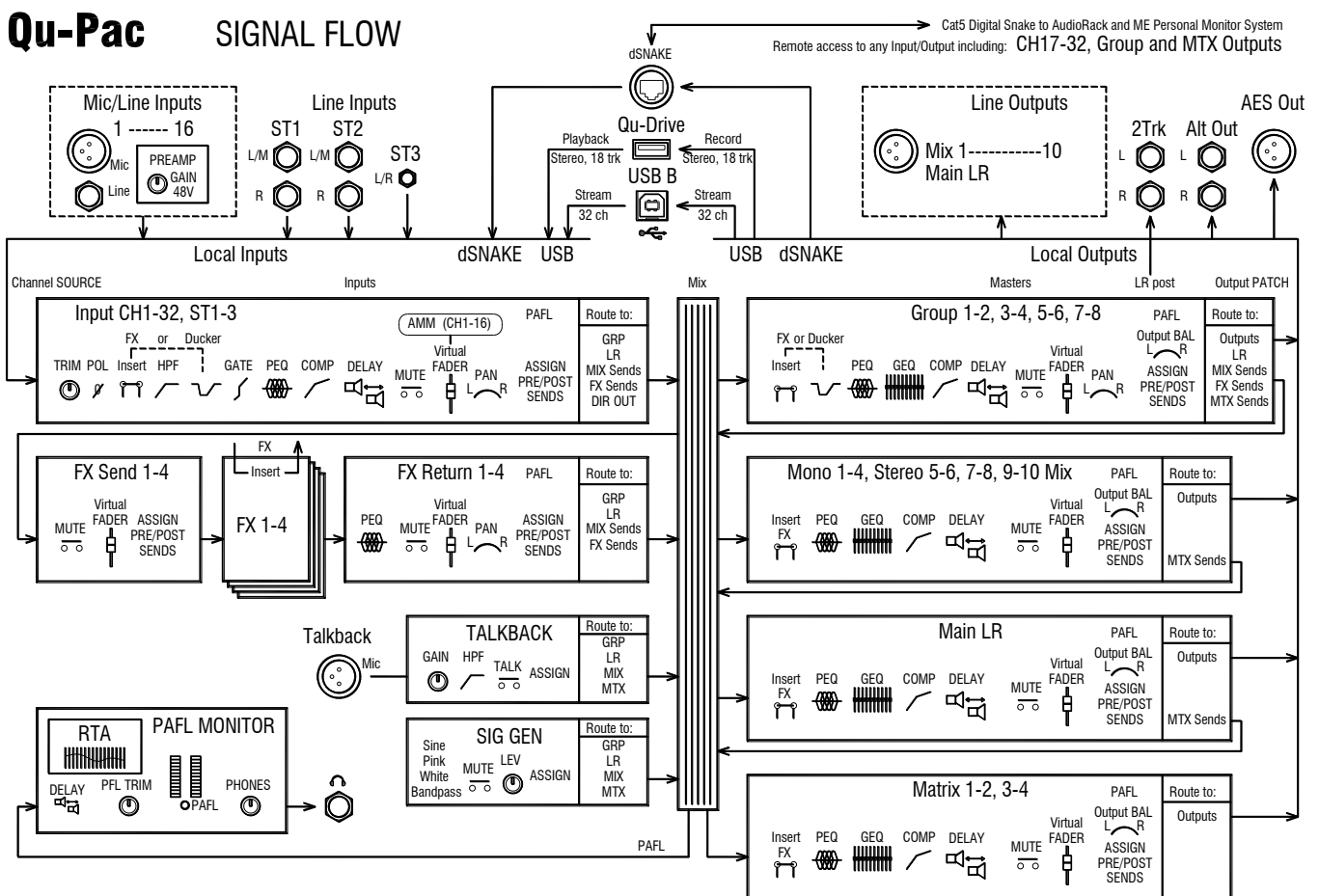

8. Wireless Control

The Allen & Heath Qu-Pad, Qu-You and Qu-Control apps are available free from the Apple Store for iOS devices including iPad, iPhone and iPod Touch. Qu-You is also available for Android devices.

Set up the Qu wireless network - For best performance use a dual band (2.4 and 5GHz) wireless router (wireless access point) with auto channel selection. Position it high up to avoid obstacles such as people and equipment. Avoid locating it behind pillars or walls, near metal beams or on top of loudspeakers. Go to the mixer **Setup / Network** screen and check that DHCP is enabled.

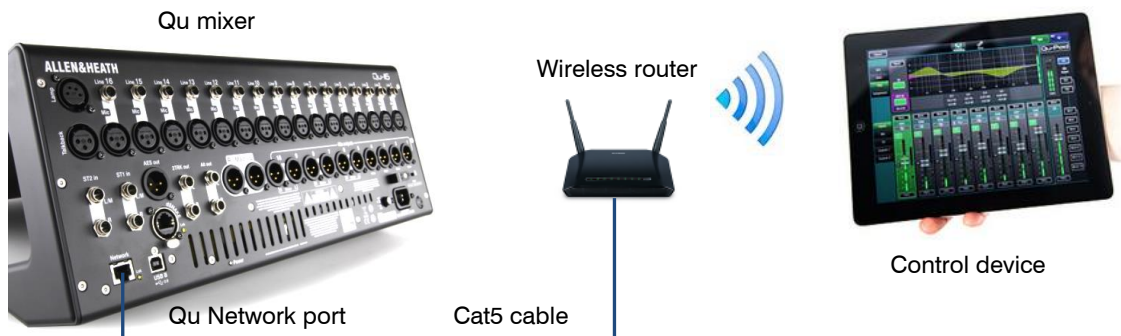

i The Qu mixer firmware and app versions must be compatible. For example, V1.9 app will not run with V1.8 firmware. To avoid unexpected version mismatch we recommend you turn off 'auto update' on your device. Download the latest Qu mixer firmware from the Allen & Heath web site.

i To prevent unauthorised control of your Qu mixer we recommend that you set a router password to protect your wireless network.

i The wireless device remembers the network settings. To prevent a guest engineer using their own device on your network without password in future, select your network in their device Settings Wi-Fi menu and use the 'Forget this network' function.

Connect to the wireless network – Power up the router. Wait a few minutes for it to establish its broadcast. Go to your wireless device Settings screen, find and connect to the mixer Wi-Fi network.

Start the app – The app opens in its Login page. You should see your Qu mixer in the list if it is recognised on the Wi-Fi network. Select this and touch Connect. A login password is required if one has been set at the mixer. Read the app Help Manual by touching the ? button on its Login or Setup page.



Qu-Pad is an engineer's mixing tool giving you the freedom to walk the room or stage and control the sound where it is needed. Qu-Pad follows the User Profiles and Permissions as set in the Qu mixer.



Qu-You provides personal monitor mix control for musicians on stage. The engineer can still keep an eye on and control each mix at the Qu mixer at any time. A password for Qu-You users can be set at the mixer.



Qu-Control is a customisable app with up to five screen tabs and up to 15 control 'widgets' per tab. These can be anything from background music source selection to a master zone level or microphone paging. A password for Qu-Control users can be set at the mixer.

9. Qu-Start

This section provides a quick guide to get you started mixing with Qu. For more information please refer to other sections in this guide and to the Qu Mixer Reference Guide available for download from www.allen-heath.com/key-series/qu-series.

9.1 Things to check before starting:

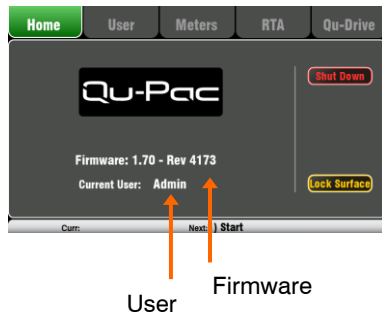

Mixer firmware version – View current version on the **Home** screen. Go to www.allen-heath.com/key-series/qu-series to check you are running the latest version. Download and update using the **Setup / Utility / Firmware** screen if you are not.

Qu-Pad, Qu-Control and Qu-You app versions – The app versions must be the same as the Qu mixer firmware version. If not, the app will not connect to the mixer. The Apple Store will always have the latest version available for free download.

We recommend you turn off your iOS device Auto Update function to prevent the app being updated before you have had a chance to update the mixer firmware.

Network and Wi-Fi settings – Plug a router (wireless access point) into the Qu Network port. Check that **DHCP is enabled** in the **Setup / Control / Network** screen. Check that your router has a password set. The Qu wireless network should be independent of any other Wi-Fi or Internet access in the building.

Current User – View this on the **Home** screen. Qu has three User Profiles. **Admin** user has access to everything and is typical for the mixer owner or senior engineer. **Standard** and **Basic** users have restricted access as set by Admin. Passwords can be set.

Calibration – You can recalibrate the touch screen accuracy using the **Setup / Utility / Calibration** screen.

Dimmer – To adjust the brightness of the touch screen and key illumination press and hold the **Setup** key and turn the rotary control. Qu powers up with maximum brightness.

9.2 Set a known starting point:



Touch and hold for 2 seconds

To completely reset the mixer you can perform a power up **System Hard Reset**. Only do this if absolutely necessary. This clears all the memories (Scenes, User Libraries, User Profiles and passwords) and resets all settings to factory default.

To zero the board as a start for setting up a new session or event you can use the **Reset Mix Settings** function on the **Scenes** page. This is a special Scene that resets all current mix parameters to factory default. It does not affect the memories and system settings and preferences.

This reset is not affected by the Global Scene Filter. It also resets the Global Filter and clears the channel Safes. Touch and hold the Reset Mix Settings button for 2 seconds and then confirm.

To set your preferred starting point you could set up and store your own template **Scene** and keep this on USB key to load into this and other Qu mixers you may use.

9.3 Prepare the mixer for your session:

Touch to name



Name the channels and masters – Working from your plot sheet, use the mixer **Processing** screens to enter names with up to 6 characters. Touch the name to open the keypad. The Qu-Pad app can also be used to enter names.

Patch input sockets



Choose the sources for the channels – You can choose one of 3 sources for each mono and stereo channel – Local (rear panel) socket, dSNAKE (remote) socket, or USB (playback). The reset default is:

- CH1-16 = Local inputs
- CH17-32 = dSNAKE inputs 1-16.

To change channel source go to the input **Processing** screen **Fn** key **Source** page.

Select dSNAKE if you are connecting a remote AudioRack via Cat5 cable digital snake. Touch 'Patch' to take you to the **Setup /I/O Patch / dSNAKE In** screen if you want to remap AudioRack sockets to different channels. The default is one-to-one mapping.

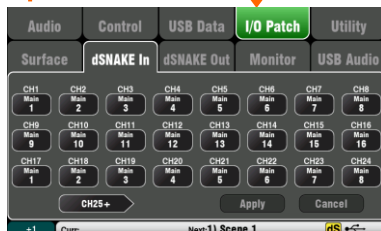

Set the Global USB Source button to choose either Qu-Drive or USB B streaming as the USB playback source. This setting affects all channels.

Check the Mix routing and pre/post fade – Mixes 1-10 can be set pre or post fader, channels can be assigned, and you can choose the send point within the channel signal path.

You can quickly set up a starting point with all on or off, and all pre or post for each mix using its master **Routing** screen.

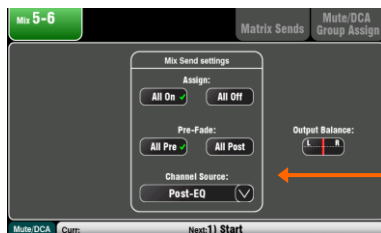

The reset default is all pre fade, all channels assigned and the sends post-EQ (not affected by the compressor). This is ideal for using the mixes as monitor sends. For effects and other sends you could change this to post fade, post Delay (after all processing).

Set up the Groups – Groups can be configured as audio subgroups or additional stereo mixes, for example for example when working with many in-ear monitors. Use its master **Routing** screen to check or change its operating mode. If you are using subgroups to LR then remember to turn off the assignments of those channels to the LR mix.

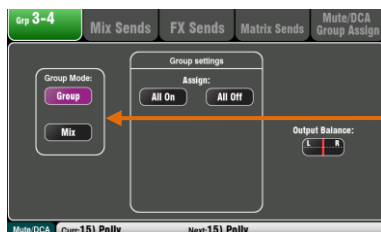

Set up the Matrix sends - Use the Matrix **Routing** screen **Fn** key **Matrix View** page to work with its send levels and routing.

View Front or Back panel



Set up the FX – Go to the **FX** screen to set up the 4 built-in FX units. The reset default sets up one reverb and a delay (Qu-16), or two reverbs, a delay and an ADT effect (other Qu models). To change these use the **Fn** key **Library** page to select and recall the FX type and preset for each.

Use the **Back Panel** view to check the FX patching. Effects such as reverb and delay use Mix->Return patching. You can also insert an FX into a channel or mix.

Choose the FX preset



Set up Mute and DCA Groups – Access their masters on the **Channel** screen. Use the **Routing** screen **Fn** key **Mute/DCA** page to name and assign the groups. It can be useful to assign a mute or DCA group to the FX returns providing a quick way to silence or reduce the effects between songs.

For quick access the group mutes can be assigned to SoftKeys.

Patching – The reset default patch is a simple one-to-one mapping of local sockets to the channels, and a traditional patch of outputs suitable for the typical PA application. However, Qu offers flexible patching letting you route signals anywhere you want.

Many of the patching screens use the **Fn** key as a '+1' increment to let you quickly step through a range of sockets. Most require confirmation to **Apply** or **Cancel** the changes you make.

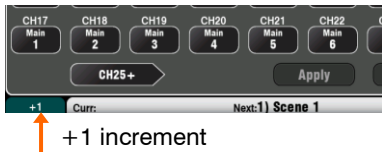

+1 increment

Patch the Alt Out and AES outputs – Use the **Setup / I/O Patch Surface** screen to patch any of the available Qu output sources to these mixer rear panel sockets. Alt Out can provide a useful stereo recording or zone feed with front panel rotary control.



Patch the dSNAKE remote outputs - Use the **Setup / I/O Patch / dSNAKE Out** screen to patch Qu outputs to any of the connected AudioRack sockets.

Choose the Direct Output application - Think about how you want to use the channel direct outputs for example USB recording, ME-1 personal monitoring, channel Ducker trigger or single channel FX. Set your source preference in the **Routing** screen of any input channel. This setting is global and affects all direct outputs.



Patching to the optional ME-1 personal monitor system - Go to the **Setup / I/O Patch / Monitor** screen to patch Qu outputs to the 40 ME-1 sends. It is typical to send the input channel direct outputs. Recommended direct out setting is post delay, pre fader, post mute.



Patch the USB outputs – Use the **Setup / I/O Patch / USB Audio** screen to patch any of the Qu outputs to the **Qu-Drive** multitrack and rear panel **USB B** streaming port. These share the same patch. USB streaming uses all 32 outputs. Qu-Drive recording is fed from the first 18 outputs. Qu-Drive stereo recording is fed from outputs 17-18.

Live show multitrack recording typically uses the channel Insert Sends so that live mixing does not affect the recording. You may wish to change this to Direct Outputs for studio recording and other applications.

Assign the SoftKeys – 15 Qu-Pac front panel keys can be user assigned for various functions such as mute, tap tempo, scenes, Qu-Drive transport and more. Assign these using the **Setup / Control / SoftKeys** screen. Use the rotary to scroll through the list of options. Confirm using the **Apply** button.

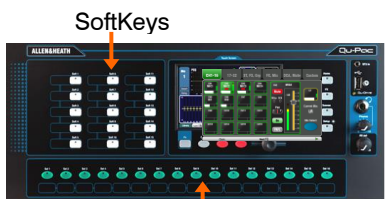

Custom Select Layer

Assign the Custom Layer – 16 Qu-Pac front panel custom Sel keys can be user assigned for any combination of channel, FX, mix, DCA and MIDI select. This can give you quick select of just the channels you are using for your show. Assign these using the **Setup / Control / Custom Layer** screen. Use the **Fn** key as a '+1' increment to let you quickly step through a range of assignments. The reset default is CH1-16.



Assign the Qu-Pad app Custom Layers – If you are using the iPad app for wireless mixing you can assign up to 3 custom layers to present the fader strips and SoftKeys you are using in the order you prefer. Select the **Setup** icon in the top toolbar.

9.4 Set a starting point for processing and mix parameters:

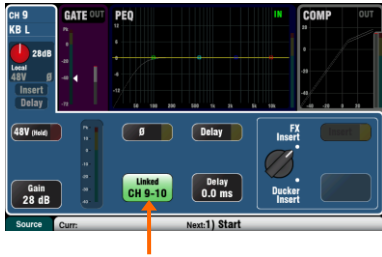

Start by using the **Processing** screen Preamp page **Linking** button to link parameters for any odd/even stereo pairs of channels you may need. For example, stereo keyboards or backing tracks. Adjusting **Pan** on one channel will set the width for the pair.

There are several ways to quickly set up the input and mix channel processing ready to start your sound check:

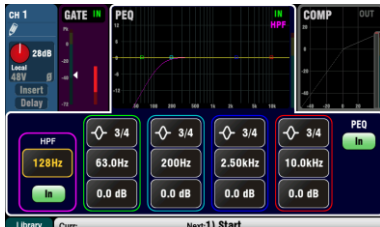

Processing Libraries – Use the **Processing** screen **Fn** key to open the **Library** page for the related block, for example the PEQ.

Factory Libraries provide presets as examples and a typical starting point. They cannot be overwritten or deleted. **User Libraries** can be stored, named and edited.



Channel Library – This preset recalls all processing (Gate, PEQ, Comp, Delay) for the input channel. Turn on 'Recall Preamp' if you want this to also include the preamp settings (Gain, Pad, 48V, Polarity). Channel libraries do not include the linking or ducker settings.

Channel libraries can provide a very quick and complete way to set a starting point before sound check once you have named your channels.

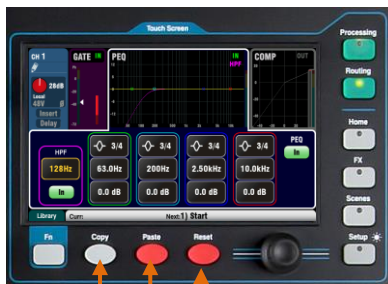

Reset parameters
Paste parameters
Copy parameters

Copy / Paste / Reset – These keys provide a powerful tool for quickly setting up your processing. They work in a similar way. Press and hold the key down. While holding, press or touch another item to perform the action:

- + Front panel **Sel** key = all related processing (not preamp)
- + **Channel** Select box = all related processing (not preamp)
- + **Processing** 'In' button = just that block, eg PEQ
- + **Processing** top of screen = just that block
- + **Processing** top of screen Gain knob = Preamp
- + **Channel** Mix Select **Mix** button = its mix levels, pan, assign

These actions do not affect channel linking or ducker settings.

Reset - Sets related parameters to factory default. For example PEQ flat, Gate out, Mix levels off, pans mid, assignments on.

Copy / Paste – Hold Copy and press/touch the item you want to copy. Then hold Paste and press/touch the channel **Sel** key, Select box, or **Mix** button you want to paste it to. You can quickly paste settings to multiple channels or mixes. For example, to copy CH2 PEQ only to CH3, 4 and 5:

Copy+CH2 PEQ top of screen, then
Paste+CH3, then CH4, then CH5 **Sel** keys

Qu-Pad app – You can also name channels, set channel linking and recall the Libraries using the Qu-Pad app.

9.5 Save the settings:

Scene memories – Once you have set up the mixer ready for the session, go to the **Scenes** screen to name and store the current mix settings as a scene.

You could name and store a scene as a **template starting point** for future shows, for each band after you sound check them, theatre show cues, recording sessions and so on.

You can store up to 100 scenes within the Qu mixer. You can copy and clear existing scenes. To copy a scene hold down the **Copy key** and touch a scene in the list. Then hold down the **Paste key** and touch the scene position to copy to. This copies all scene parameters, its name and filter.



Touch and hold for reset

Reset Mix Settings – This lets you zero the desk ready to start a new mixing session. It resets all mixing parameters and clears existing Safes and Global Filter settings. It does not affect scenes, libraries and user preferences.

A dot shows one or more assigned



Scene Safes – This function protects **all parameters of a selected channel or mix** from being overwritten when a scene is recalled. For example, walk-in music, DJ or presenter. This means that any changes you make on those channels after the sound check has been stored will not be lost when you recall that scene later. Use the **Scenes / Safes** screen. The reset default is no safes set.

Groups of parameters

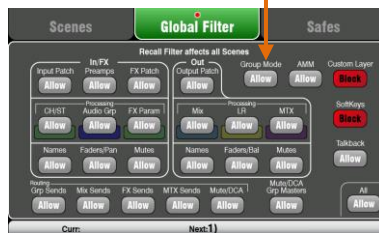

Global Scene Filter – This function protects **selected parameters of all channels or mix** from being overwritten when **any scene** is recalled. For example, the SoftKey or Custom Layer assignments that you may make after sound check, or the LR mix processing including GEQ which you may change as the audience fills the room. Use the **Scenes / Global Filter** screen. This presents a grid of buttons to block different groups of parameters for different channel types. The reset default is Custom Layer and SoftKeys blocked.

Per Scene Filter – This is similar to the global filter but protects selected parameters for just **one scene** recall. Each scene has its own filter. This can be a powerful tool, for example when recalling cues in a theatre show, or effects changes during songs. You can copy and clear individual scene filters. The reset default is Custom Layer and SoftKeys blocked.

Show memories – A Show stores everything including the current mix settings, all 100 scenes, libraries and setup. Shows are not stored within the mixer. They are created directly to a USB drive in the Qu-Drive socket.

ⓘ Do not edit file names or locations on the USB key.

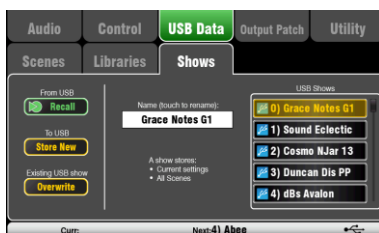

Archiving and transferring data via USB – You can use a USB device such as key or drive to archive Qu settings or transfer them between Qu mixers. The memories are compatible with all Qu models. Start by formatting the USB device on the Qu mixer. Use the **Setup / Utility / Qu-Drive** screen Format function.

ⓘ Formatting will erase any existing data and create a Qu directory on the device. You only need to format the USB device once on the Qu mixer. Do not attempt to edit the Qu data or file names using a computer. Keep the USB device for use with the Qu mixer only.

Go to the **Setup / USB Data** screen to transfer Scenes, User Libraries and Shows files.



9.6 Mixing with Qu-Pac:

Wireless mixing

Qu-Pad app – This is an engineers tool that lets you mix using wireless iPad control via a Wi-Fi router plugged into the Qu Network port. You can connect up to two iPads running Qu-Pad.



Qu-You app – Lets musicians mix their own monitors using wireless iPhone, iPad, iPod Touch or Android device control via the router. It prevents access to the main LR mix and can be locked to one mix. You can connect up to 8 iOS devices running Qu-You. The maximum number of devices you can connect is 8. For example, one Qu-Pad and 7 Qu-You.

You can protect against unauthorised access by setting a password for Qu-You login at the mixer.

Use the Qu-Pad Custom Layer and Qu-You assignable group wheels to customise the layout to the way you want to work. Refer to the app Help page.

Reset default for the SoftKeys:

- 1-4 = Mute Group 1-4
- 5-13 = unassigned
- 14 = PAFL Clear
- 15 = Talk

Live mixing screens



Assignable SoftKeys and Custom Layer

Qu-Pac front panel mixing

Part of the design brief for Qu-Pac was to be able to access every channel and function from the front panel. This means you can mix simple shows or conferences without the need for an iPad, and also gives you a backup if you experience Wi-Fi interference problems.

User assignable **SoftKeys** can provide quick access to important functions for your event.

The User assignable **Custom Select Layer** can provide quick access to any combination of channels, FX, mixes and DCAs you are using for your event.

Channel screen – This is the main mixing screen. It replaces the fader section of the other Qu mixer models with an on-screen 'Virtual Fader Strip' and **Select buttons** arranged in tabs to access every input channel, FX, mix and DCA masters.

Touch to select a channel.

The select buttons show names, levels, meters, mute and routing status.

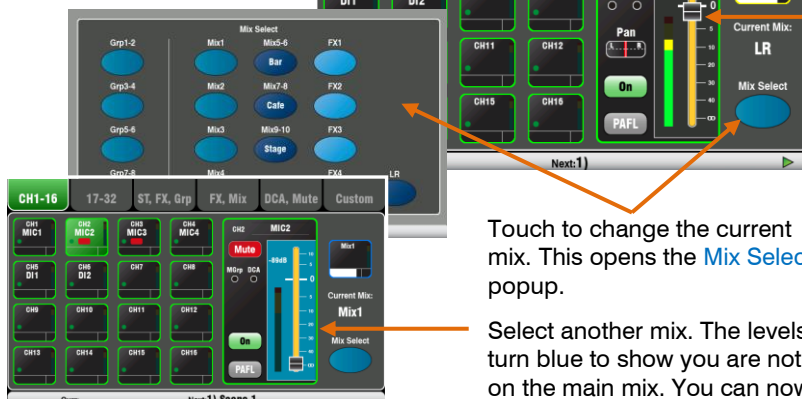

Touch to name the channel.

Touch to select the current mix master.

Touch the **Fader** and use the rotary to adjust its level for the selected channel to the current mix.

Touch **Pan** and use the rotary to position the signal between L and R.

Touch to toggle **Mute**, the routing **On/Off** to the current mix, and **PAFL** headphones monitoring.

The lower toolbar shows Scenes, Qu-Drive and system status.

i Remember to return to the LR mix once you have finished adjusting another mix.

Touch to change the current mix. This opens the **Mix Select** popup.

Select another mix. The levels turn blue to show you are not on the main mix. You can now adjust the sends to that mix.

Channel screen Custom page

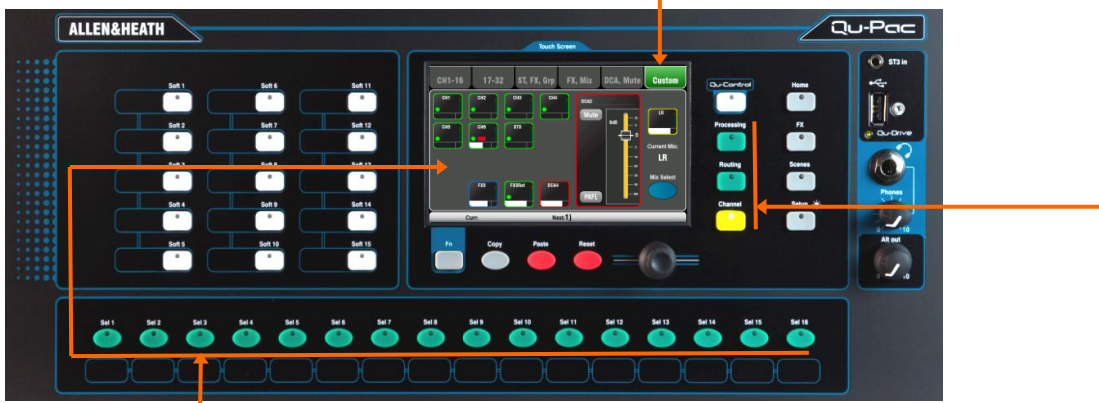

Custom Select keys

Mixing with the Custom Select keys – Press to select a channel, master, DCA group or MIDI strip that has been assigned to these quick access keys.

Use the **Channel / Custom** screen to work with the faders, pan, mutes, routing and mix sends. Use the **Processing** screen to work with the preamps, gates, EQ, compressors and delays. Use the **Routing** screen to work with the mix assignments and routing options.

Processing screen – This screen lets you work with the processing for the selected channel or master.

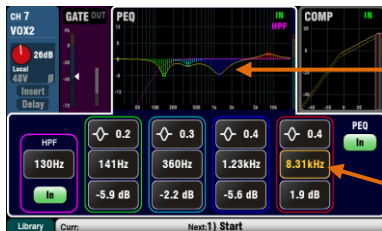

Touch the top part to open the related **parameters** in the section below. The top part can also be used with the **Copy/Paste/Reset** keys to quickly copy or reset different processing blocks.

Touch a parameter box to highlight it, then use the rotary control to change its value.

Use the **Fn** key to open any available extra pages for the current processing view:

- Preamp = Source select (input patching)
- Gate, PEQ, GEQ, Comp = Library

FX Parameters – Select an FX Send or Return channel and open the **Processing** screen to view and work with its effects parameters. Touch 'Expert' if you wish to experiment with many more of its advanced parameters. Use the **Fn** key to open the Library page to change the FX type and store or recall presets.



Routing screen – This screen lets you work with the sends from one channel to all the mixes, or access global settings and routing options for the mixes. To work with the sends from all channels to one mix use the **Channel** screen Mix Select function.

You can also use the **Routing** screen **Fn** key to access the Matrix sends while a Matrix is selected, or the Mute/DCA group assignments and naming while anything else is selected.



SoftKeys - Use these for quick access to functions such as commonly used mutes, recalling specific scenes, navigating scenes, tap tempo, Qu-Drive transport control, talkback to the stage, clearing active PAFL and more. SoftKeys are assigned using the **Setup / Control / SoftKeys** screen.

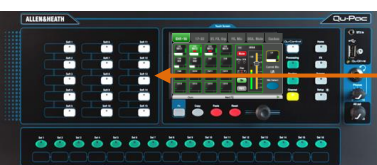

9.7 The Qu-Control screen

Qu-Control is a custom assignable screen to present just the few controls needed for basic operation. For example, to control background music source and level within a music bar. It can be associated with the Qu 'Basic User' with permissions set by the 'Admin' user so that only this screen is available for non-technical bar staff to adjust the background music. Access to the live mixing and setup functions can be locked out for the Basic User.

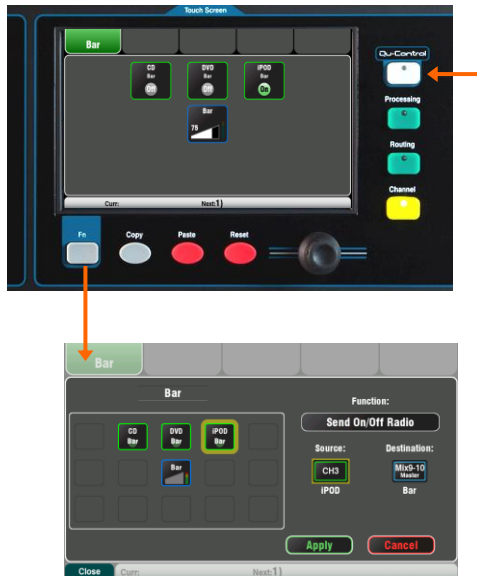

Operating Qu-Control - Press to open the Qu-Control screen. This presents buttons and level controls configured by the Admin user. If none have been configured the screen will be blank. Tabs allow access to up to 5 custom screens.

Touch a button to toggle its state. Touch to highlight a level control and adjust it using the screen rotary.

Setting up Qu-Control - The Admin user can configure which controls are presented and how they are positioned on the screen.

Press the **Fn** key to open the Qu-Control setup page for the currently active tab. Controls can be assigned to up to 15 positions arranged as a grid of 3 rows with 5 columns. If a position is unassigned then it will appear blank in the user screen. Touch to open the Function list. You can choose mutes, level or assignments (On/Off) associated with channels or mixes. **Send On/Off Radio** lets you assign a selection of buttons to operate in interlocked 'radio mode' where pressing one will turn the others off.

Touch and spin the rotary to scroll through the channels or mixes. Once assigned, press **Apply**.

i Qu-Control settings are stored to USB device as part of the Show file. They are not stored in Scene memories.

9.8 Security and user access

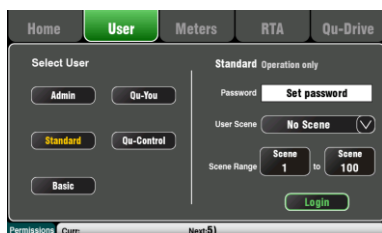

Qu features several functions that protect the system from unauthorised mixer or app access, and restrict how much control is given to certain operators. For example, to prevent a regular event operator from changing the configuration, or to limit non-technical bar staff to simple control of just the background music and paging.

Lock Surface - Use this button on the **Home** screen to protect the surface controls while the mixer is unattended. If a password has been set then this will be needed to enter and exit surface lock.

User Permissions - There are three User Profiles available:

Admin - Has access to everything. Can configure the mixer, set permissions and passwords, and set up the Qu-Control screen.

Standard - Can control the live mix but is locked out of system setup functions.

Basic - Can control faders and mutes only, or be locked out of everything except the Qu-Control screen.

Passwords can be set for each of these three users. These are required at login and surface lock. The Qu-Pad app follows the same User Permissions. Admin can set a separate password for Qu-You and Qu-Control users. A scene range and login scene can be set for the Standard and Basic users.

9.9 USB recording and playback:



USB B Streaming – Connect an Apple® Mac or Windows® PC computer to the rear panel USB B port to stream up to 32 channels of audio in both directions and send MIDI messages.

You can download the Allen & Heath [DAW Control driver](#) (for Mac computer only) to convert the Qu MIDI Strip messages into HUI or Mackie Control protocol. Download the Allen & Heath [Qu Windows driver](#) to stream standard MIDI messages to a PC.

Set the Qu MIDI channel number using the **Setup / Control / MIDI** screen.

Patch recording sources



Qu-Drive recording direct to USB drive – You can record [stereo](#) or [18-track multitrack](#) direct to a USB storage device plugged into the front panel Qu-Drive port.

Note - Qu-Drive recording requires the USB storage device to support high sustained transfer rates. Not all USB devices will guarantee flawless performance. To find out more please refer to the '[Understanding Qu-Drive and USB](#)' document in the Qu Knowledgebase on the Allen & Heath web site. Use the USB storage device with the Qu mixer only. Do not use it for other applications.

Format the USB device on the Qu mixer before recording using the **Setup / Utility / Qu-Drive** screen. This clears the drive and sets up the Qu directory structure.



Patch the sources to record using the **Setup / I/O Patch / USB Audio** screen. Use the rotary to spin through available sources to each of the 18 tracks. Press the **Fn** key '+1' to increment quickly through the tracks. Choose channel sources to be from Insert Sends or Direct Out.

Stereo recording uses the same source as multitrack CH17 and 18.

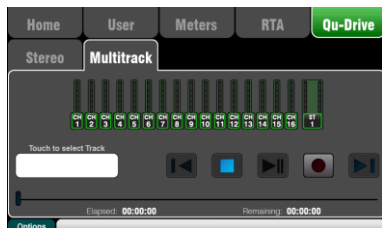

Record Stereo or Multitrack using the **Home / Qu-Drive** screen. Recording creates WAV files in Qu directories on the USB device.

ⓘ Do not edit the name or contents of files on the USB device. To avoid errors, we recommend you reformat the device on the Qu mixer before your next session if you copy or delete files using a computer.

Patch recording sources

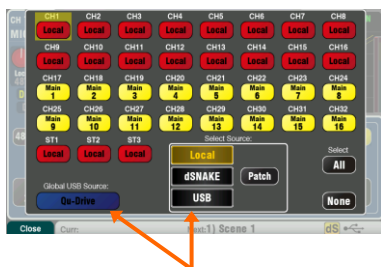

Play back Stereo or Multitrack using the **Processing** screen Preamp page **Fn** key view. Choose 'USB' as the source to the channels. Select 'Qu-Drive' as the Global USB Source.

Using SoftKeys for transport control – You can assign transport controls for stereo or multitrack recording or playback using the **Setup / Control / SoftKeys** screen. For example, to arm, start and stop recordings while using the screen for other mixing functions.

9.10 A few more functions

Start with the level turned down

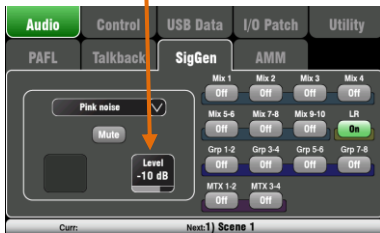

① Turn the mixer on first, amplifier/speakers on last.

Pink noise is an excellent source for testing speakers. It generates equal energy per octave across all frequencies. It can be used to check that all speaker drivers are working and to listen for phasing and polarity issues.

Set the LR and monitor master faders to their normal operating position. Go to the **Setup / Audio / SigGen** screen. Select Pink Noise and make sure its Level is fully off. Now select LR and slowly raise the SigGen level to hear the noise in the PA speakers. Also test the monitor speakers in this way.

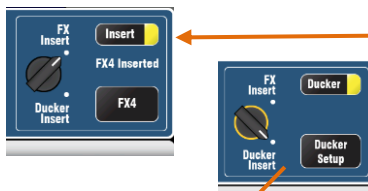

Inserted FX – You can insert an internal FX (reverb, delay or modulation) directly into an input channel or mix master signal path. Balance between the unaffected (dry) signal and the effect (wet) using the D/W control in the **FX** screen.

Channel Ducker – You can insert a ducker into input channels or groups. This lets you use any Qu signal to automatically duck (attenuate) other channels when active. For example, use a paging mic as a trigger to duck the background music channel. Adjust how fast it ducks and recovers.



Automatic Mic Mixing (AMM) – This is very useful for speech applications such as conferences and seminars involving several microphones around a table. The Qu AMM can automatically take over the level of these mics to improve clarity and reduce the risk of feedback caused by many open microphones.

To set up the AMM, start with the mix master fader turned down. Use PAFL to check each mic signal and set preamp gain for a healthy meter reading for speech at the expected distance from the mic. Go to the **Setup / Audio / AMM** screen and turn on the associated mic channels. Their fader levels will jump to their '0' open position. Now slowly bring up the mix master fader. We recommend you use a DCA or audio Group as a master fader for the speech mics if you are also mixing other audio sources.



Refer to the Qu Mixer Reference Guide for more about how the AMM works and can be used.



Ring out the monitors – The Qu-Pad app gives you the freedom to stand in front of a vocal mic on stage and use the iPad to dial the vocal into the monitor speaker and tune out any ringing (feedback) you hear using the mix GEQ. Touch the Master strip Mix button for the monitor mix. The strip becomes the master for that monitor mix. Touch to select it and open the GEQ tab. Touch its PAFL button to send the signal to the RTA. The fader strips present the sends to that monitor mix. Raise the vocal channel send fader to hear your voice in the monitor. Carefully raise the fader until you just start to hear a frequency ring. A red dot in the RTA display above the GEQ will show which frequency is ringing. Pull back its GEQ slider a few dB until the ring stops. Slowly raise the vocal level again until you hear the next frequency ring. To avoid degrading the overall tone of the sound do not tune out too many frequencies in this way.

10. Resetting the Mixer

There are two ways to reset the Qu settings to give you a known starting point:

10.1 Reset Mix Settings – A starting point for mixing



This button in the **Scenes** screen instantly resets the mixer to a known starting point for mixing. It provides a quick way to reset the processing, mixes and patching before a show or after another user has finished with it.

All parameters that can be saved in scenes are reset to a factory default to 'zero the board' ready for the new mixing session.

If you want to keep your current settings then save these as a Scene before resetting the mixer.

This reset only affect parameters that are stored in Scenes. It does not affect existing scenes and libraries stored in the mixer.

i This reset is not affected by the Global Filter and Safes settings. However, it does reset the filter and clear any channel safes that were previously set.

Touch and hold the **Reset Mix Settings** button for 1 second until the confirmation screen appears.

Creating your own start settings – You can start by resetting the mixer and then editing the patching, levels and parameters to suit your starting preferences. Name and store this as a **Scene**, for example Scene 1 "Reset Board".

Refer to the Qu Mixer Reference Guide for further information on the reset functions.

10.2 System Hard Reset – Clear everything



Hold for 5 seconds while powering up the mixer



A power up reset is available if you need to fully reset the Qu mixer settings and its memories. This could be done to clear the system out before sending the mixer to a client, or if you suspect a system problem.

To reset mix parameters before starting a show or sound check, use a Scene or the Reset Mix Settings function.

i A hard reset sets all current settings to factory default, and clears all Scenes, User Libraries, User Permissions and passwords.

First turn off the system including amplifiers and powered speakers.

To hard reset the Qu mixer - Press and hold the touch screen Reset and Setup keys together and then power up the mixer. Keep the keys pressed for at least 5 seconds while the mixer boots. Release the keys.

Refer to the Qu Mixer Reference Guide for more information on these and other Qu hardware and operational functions.